

# R82 Manatee

## USD Retail Price List/ Order Form

Account #: \_\_\_\_\_ Purchase Order No.: \_\_\_\_\_ Date: \_\_\_\_\_  
 Contact: \_\_\_\_\_ Mark For: \_\_\_\_\_

Bill To:	Ship To:
Address:	Address:
City/State/Zip:	
Phone:	City/State/Zip:
Email	Phone:

### US Configuration

Effective: 08.24.20 - Rev 3

- Manatee
- Head support
- Leg belts
- Frame



- A (Back Height) \_\_\_\_\_
- B (Arm Height) \_\_\_\_\_
- C (Lower Leg Length) \_\_\_\_\_
- D (Seat Depth) \_\_\_\_\_
- E (Chest Width) \_\_\_\_\_
- F (Seat Width) \_\_\_\_\_
- G (Height-Seat to Top of Head) \_\_\_\_\_
- H (Shoulder Width) \_\_\_\_\_
- Age \_\_\_\_\_
- Weight \_\_\_\_\_

### Measurements

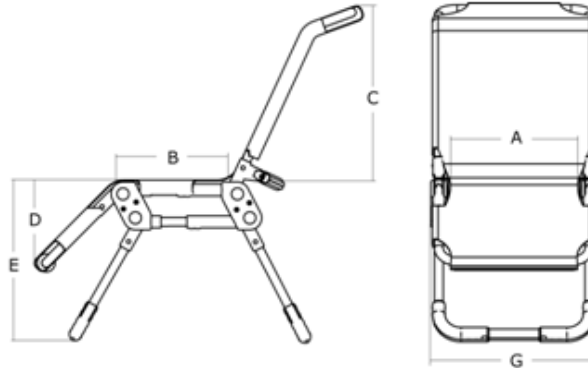

<b>Manatee</b>	<b>Size 0 Inches</b>	<b>Size 1 Inches</b>	<b>Size 2 Inches</b>	<b>Size 3 Inches</b>
Seat Width (A)	12¾"	12¾"	12¾"	15½"
Seat Depth (B)	8½ - 9¾"	11¾ - 14½"	15¼ - 18"	15½"-18¼"
Back Height (C)	16¾"	16¾"	22½"	25"
Lower Leg Length (D)	11"	11"	13¾"	13¼"
Seat Height (E)	5½ - 16¾"	5½ - 16¾"	5½ - 16¾"	5½-16¾"
Total Width (G)	16½"	16½"	16½"	19"
Length Folded	"40 - 43"	43 - 45¾"	53 - 55¾"	56-58¾"
Height Folded	5"	5"	5"	5"
Weight	12 lbs.	12 lbs.	13.25 lbs.	15½"
Max. Load	110 lbs.	110 lbs.	165 lbs.	165 lbs.

**Measurements**

<b>Frames</b>	<b>Shower Frame</b>	<b>Bath Tub Frame</b>
Width	23"	17"
Length	38¼"	28½" - 43¼"
Height	-	10½"
Height, Minimum	14¾"	-
Height, Minimum, with Chair	29¾"	-
Height, Middle	17"	-
Height, Middle, with Chair	32¾"	-
Height, Maximum	18¾"	-
Height, Maximum, with Chair	35¼"	-
Height, Folded	8"	-
Weight	17½ lbs.	4½ lbs.
Max. Load	165 lbs.	165 lbs.

**Manatee Standard Features**



- Manatee comes in 4 sizes; 0, 1, 2 or 3
- Head/Lateral Support
- Height Adjustable Foldable Frame
- Cover in Red or Blue Soft Nylon
- Belt for Waist/Hip
- HCPCS n/a for Manatee

<b>Description</b>	<b>Size</b>	<b>Part No.</b>	<b>USD Price</b>
--------------------	-------------	-----------------	------------------

**Required, must select a color**

**X = Color**

Blue = 5

Red = 4

<input type="checkbox"/> Manatee, Blue *	0	882005	\$700
<input type="checkbox"/> Manatee	1	88201X	\$700
<input type="checkbox"/> Manatee	2	88202X	\$700
<input type="checkbox"/> Manatee	3	88203X	\$765

*\* Size 0 is only available in Blue*

<b>Frame</b>	<b>Description</b>	<b>Size</b>	<b>Part No.</b>	<b>USD Price</b>
--------------	--------------------	-------------	-----------------	------------------



Basic Manatee Frame One Size 882101 \$350



Rolling Shower Frame One Size 882100 \$710

Wall Mount for Frame One Size 882110 \$155

**Required, must select a color**

**X = Color**

Blue = 5





Red = 4

Net for Frame \* One Size 88210X \$71

*\*Custom order; Approx. lead time: 6-8 weeks*

**IMPORTANT: No returns or exchanges accepted for this product**

Frame	Description	Size	Part No.	USD Price
	<input type="checkbox"/> Tub Slider without Manatee w/ Casters (W: 50") *	1, 2	MC6000PED	\$3,265
	<input type="checkbox"/> Tub Slider without Manatee w/ Casters (W: 50")	3	MC6200PED	\$3,980
<i>*Custom order; Approx. lead time: 6-8 weeks. Non-returnable item</i>				

Accessories	Description	Measurements	Size	Part No.	USD Price
<b>Required, must select a color</b>					
<b>X = Color</b>					
<input type="checkbox"/> Blue = 5					
<input type="checkbox"/> Red = 4					
	<input type="checkbox"/> Head/Lateral Support		0, 1, 2	88301X	\$110
	<input type="checkbox"/> Head/Lateral Support		3	88306X	\$110
	<input type="checkbox"/> Torso Belt		0, 1, 2	88302X	\$77
	<input type="checkbox"/> Torso Belt		3	88307X	\$77
	<input type="checkbox"/> Leg Straps		0, 1, 2	88305X	\$77
	<input type="checkbox"/> Leg Straps		3	88310X	\$97
	<input type="checkbox"/> Pommel		0, 1, 2	88304X	\$97
	<input type="checkbox"/> Pommel *		3	88309X	\$97
<i>*Pommel sz 3 in RED is a custom order; Approx. lead time: 6-8 weeks</i>					

Spare Parts	Description	Measurements	Size	Part No.	USD Price
	<input type="checkbox"/> Belt for Waist/Hip		0, 1, 2	88303X	\$77
	<input type="checkbox"/> Belt for Waist/Hip		3	88308X	\$77
<b>Required, must select a color</b>					
<b>X = Color</b>					
<input type="checkbox"/> Blue = 5					
<input type="checkbox"/> Red = 4					
	<input type="checkbox"/> Cover *		0	882205	\$255
	<input type="checkbox"/> Cover		1	88221X	\$255
	<input type="checkbox"/> Cover		2	88222X	\$255
	<input type="checkbox"/> Cover		3	88223X	\$255
<i>* Size 0 is only available in Blue</i>					

**IMPORTANT: No returns or exchanges accepted for this product**

Prices in USD & is subject to change without notice