

# Pelvic Support Belt

INSTALLATION AND USER'S INSTRUCTIONS

ART NOS. HB2, HB4, LB2, LB4, NB2 & SB2

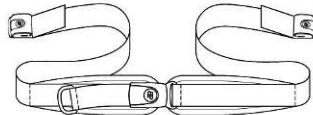
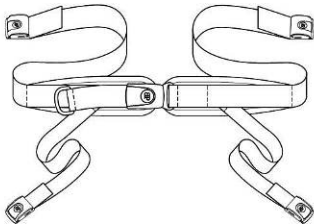

These instructions provide important information for the safe use and maintenance of all Bodypoint pelvic support belts. Give these instructions to the user or their caregiver and review them to ensure that they are understood.

**⚠ WARNING!** Product should be installed and fitted by a qualified rehab technician.

#### USE:

**⚠ WARNING!** This product should only be used for positioning a person in a wheelchair or work chair. It is NOT intended for use as a transportation safety device, as a personal restraint device, or in any other application where its failure could result in injury. Misuse of this product is unauthorized and unsafe.

**⚠ WARNING!** This pelvic support belt must be worn tightly fitted across the lower pelvis or thighs at all times. A loose belt can allow the user to slip down and create a risk of strangulation. Have your seating specialist demonstrate its proper adjustment and use. (Note: Four-point belts may safely be worn across the upper pelvis if secondary straps are anchored to prevent change in position.)

**⚠ WARNING!** Accidental release of this pelvic support belt can allow the user to slip down or fall from the wheelchair. If the user's movements or cognitive abilities could lead to accidental release, a caregiver must be present at all times during its use. Ensure that all caregivers know how to unfasten the product. Failure to do so may delay release in an emergency.

**⚠ WARNING!** As with any new seating support, this product may change the way a per-

son sits. Users must continue to practice regular pressure relief activities and skin integrity checks, not only where this product contacts the user, but also in primary pressure-bearing areas such as the sacrum, legs, and buttocks. If increased skin redness or irritation occurs, discontinue use and consult your physician or seating specialist. Failure to do so may result in serious injury, such as pressure ulcers.

**MAINTENANCE:** Check periodically for signs of wear in the stitching, webbing, and pads. If significant wear is found, contact your supplier for qualified repair or replacement by Bodypoint. Under no circumstance should this product be altered or repaired by unqualified persons—health and safety depend on it!

**🧺🔥🚫🧼 CLEANING:** Machine wash, hot, 60°C (140°F). Do not bleach. Tumble dry, low temperature, or drip dry. Do not iron. (Placing the product inside a cloth bag during washing helps prevent scratches to the product and the machine.)

**WARRANTY:** This product carries a limited lifetime warranty against defects in workmanship and materials arising under normal use by the original consumer. Contact your supplier or Bodypoint for warranty claims.

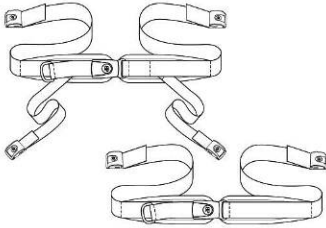

#### PACKAGE CONTENTS

- Pelvic Support Belt
- Cinch-Mount™ or Flat-Mount™ End Fittings
- FrameSaver™ Clamps (Optional)

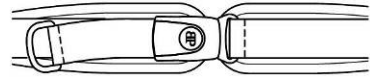

**INSTALLATION** For padded pelvic support belts, keep the adjustment straps tightened so the pads touch. For non-padded pelvic support belts, pull 5-6" webbing through the buckle.

#### TWO-POINT PELVIC SUPPORT BELTS

1. Locate desired anchor point.
2. Attach FrameSaver and Cinch-Mount to wheelchair frame.
3. Center the belt on the pelvis and thread the webbing end through the Cinch-Mount.
4. Cinch the webbing snug.

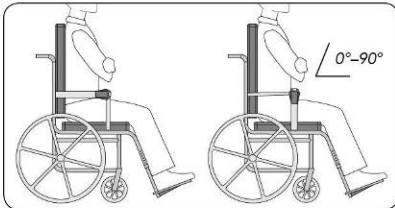
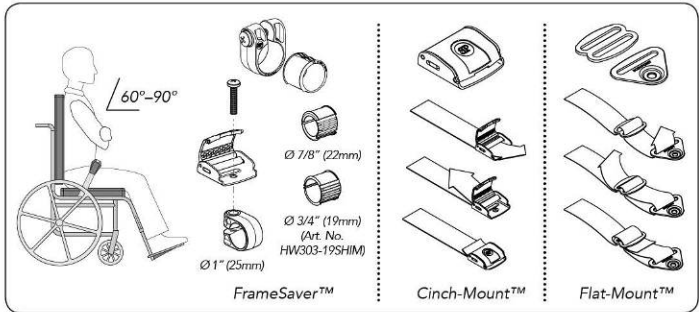

#### FOUR-POINT PELVIC SUPPORT BELTS

1. Locate desired anchor point.
2. Follow the installation instructions above to fit the primary straps.
3. Attach the secondary straps to the chair so that they anchor the primary straps.
4. Tighten secondary straps to prevent movement of the primary straps.

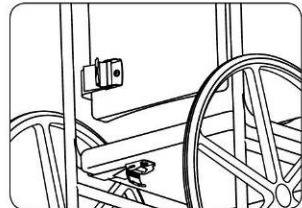

#### DIRECT MOUNTING

End fittings can be attached directly to solid seat surfaces. Mounting screws must have minimum pullout strength of 200lbs/90kg. (Not included in package.)

#### ADJUSTMENT

When properly adjusted and the belt tightened, it should fit snug so that the user's pelvis is secure. On padded belts, tighten the D-ring pull until all slack is removed and the pads under the buckle are touching. If length adjustment is necessary to achieve a good fit or to remove the belt for cleaning, this can be done using the belt end fittings.

#### SAFETY CHECK

When properly positioned in wheelchair, have user lean forward and side to side to check fit.

Check for:

1. Normal operation of buckle and adjustment straps.
2. Comfort – Look for areas of irritation.
3. Position – If too high or too low, adjust anchor points.
4. Interference with other devices – Relocate anchor points as necessary.

