

ACTA-BACK® Contour Back Support Order Form



SEATING + POSITIONING

HCPCS CODING: E2620/E2621 - POSITIONING BACK,
PLANAR WITH LATERAL SUPPORTS

Since U.S. Medicare coding is subject to change, the provider should always confirm the HCPCS code and coverage criteria as part of the client assessment process.

Company Name/ACCT #: _____

P.O. Number: _____

Requested By: _____

Phone: _____ Fax: _____

Email: _____

Ship To: _____

Client Reference: _____



Shown with Compass® 4 Quick Release 2 Point Hardware.
Cover appearance may vary with hardware selection.

DO NOT SEND PROTECTED HEALTH INFORMATION. IT IS NOT NEEDED TO MAKE THE PRODUCT YOU ARE REQUESTING.

1 SIZE SELECTION Required

ACTA-BACK Contour 5 BASE MSRP BY SIZE

LENGTH*	22"	\$624.00		\$700.00	
	20"				
18"					
16"					
	16"	18"	20"	22"	24"
	FRAME WIDTH				

Sizes available are subject to hardware being used.

ACTA-BACK® Contour 5 Part Number

ABC5-BS _____

ACTA-BACK Contour 8 BASE MSRP BY SIZE

LENGTH*	22"	\$649.00		\$725.00	
	20"				
18"					
16"					
	16"	18"	20"	22"	24"
	FRAME WIDTH				

Sizes available are subject to hardware being used.

ACTA-BACK® Contour 8 Part Number

ABC8-BS _____

Please fill in one of the above part numbers with dimensions from the size charts to the right.
Example Part: ABC5-BS18W16L

Hardware will be selected in Section 2.

*Length (L) refers to the actual size dimension of the support from bottom to top edge.

Sizes available with 2 POINT Hardware

LENGTH*	22"	16W22L	18W22L	20W22L	22W22L	
	20"	16W20L	18W20L	20W20L	22W20L	
	18"	16W18L	18W18L	20W18L	22W18L	
	16"	16W16L	18W16L	20W16L	22W16L	
		16"	18"	20"	22"	24"
	FRAME WIDTH					

Sizes available with 4 POINT Hardware

LENGTH*	22"	16W22L	18W22L	20W22L	22W22L	24W22L
	20"	16W20L	18W20L	20W20L	22W20L	24W20L
	18"	16W18L	18W18L	20W18L	22W18L	24W18L
	16"	16W16L	18W16L	20W16L	22W16L	
		16"	18"	20"	22"	24"
	FRAME WIDTH					

Sizes available with POWER Hardware

LENGTH*	22"	16W22L	18W22L	20W22L	22W22L	24W22L
	20"	16W20L	18W20L	20W20L	22W20L	24W20L
	18"	16W18L	18W18L	20W18L	22W18L	24W18L
	16"	16W16L	18W16L	20W16L	22W16L	
		16"	18"	20"	22"	24"
	FRAME WIDTH					

ACTA-BACK CONTOUR-ORDER REV120320

2 COVER & HARDWARE SELECTION

Required

2.1 COVER SELECTION

MSRP \$0.00

Both fabrics are made without latex. Fabric selection is for the support surface only. Other fabrics used in cover construction remain the same.



COMFORT-TEK® is a smooth, easily cleaned surface. The fluid protection aids in infection control.



STRETCH-AIR® has comfortable stretch, air transmission and heat dissipation. It is not fluid resistant.

COMFORT-TEK Cover
(COMFORT-TEK)

STRETCH-AIR Cover
(STRETCH-AIR)

2.2 HARDWARE STYLE

COMPASS 4 QUICK RELEASE

Price included in back support purchase

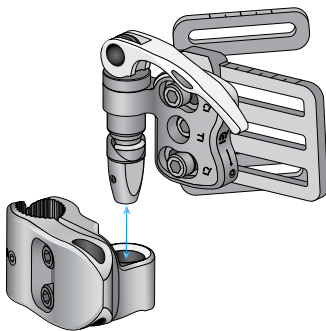

QUICK RELEASE 2 POINT
(Q-COMPASS)

QUICK RELEASE 4 POINT
(Q-COMPASS4)

4 POINT hardware is required on all 24"W back supports using Compass 4 hardware.

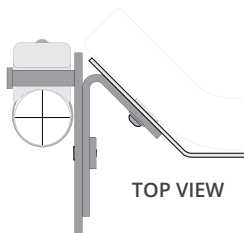

COMPASS 4 FIXED

Price included in back support purchase

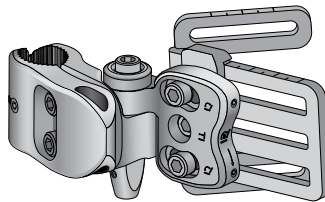

FIXED fully adjustable hardware requires tools for back support removal

FIXED 2 POINT
(NQ-COMPASS)

FIXED 4 POINT
(NQ-COMPASS4)

COMPASS POWER MOUNT

MSRP add \$40.00

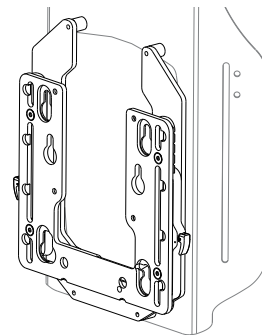

POWER MOUNT hardware has 8" of height adjustment in 1/2" increments without using tools.

QUANTUM w/ TRU BALANCE 3
(PMB-QUANTUM)

PERMOBIL w/ CORPUS 3G
(PMB-PERMOBIL)

QUICKIE w/ 3.7 POWER
(PMB-QUICKIE)

AVID REHAB w/ POWER T & R
(PMB-AVID)

ROVI w/ MOTION CONCEPTS*
(PMB-ROVI)

*Using Power Mount Hardware on ROVI requires mounting to the RECESSED PLANAR INTERFACE PLATE available when ordering the Motion Concepts Seating System. Drilling is required for mounting.

3 BACK SUPPORT ADD-ON SELECTIONS

3.1 PRIVACY FLAP

MSRP \$37.00

This flap connects with hook & loop attachment between the seat and back for added privacy.

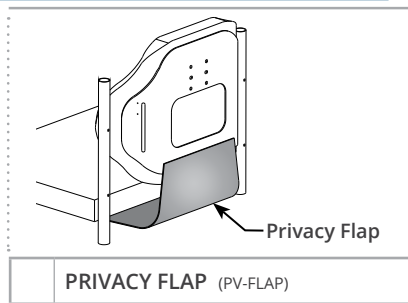

4 BODILINK® HEAD SUPPORT HARDWARE & PADS

4.1 PREMIUM PAD SIZE

HCPCS CODING: E0955 MSRP \$237.00

Length (L) refers to the actual size dimension of the support from bottom to top edge.

W		Pad Firmness		
L	6W x 3L	Soft	BL-HSP1-6W3L	
		Extra Soft	BL-HSP2-6W3L	
L	8W x 4L	Soft	BL-HSP1-8W4L	
		Extra Soft	BL-HSP2-8W4L	
L	10W x 5L <i>with adjustable wings</i>	Soft	BL-HSP1-10W5L	
		Extra Soft	BL-HSP2-10W5L	
L	12W x 5L <i>with adjustable wings</i>	Soft	BL-HSP1-12W5L	
		Extra Soft	BL-HSP2-12W5L	
L	14W x 5L <i>with adjustable wings</i>	Soft	BL-HSP1-14W5L	
		Extra Soft	BL-HSP2-14W5L	
L	18W x 5L <i>with adjustable wings</i>	Soft	BL-HSP1-18W5L	
		Extra Soft	BL-HSP2-18W5L	



Premium Head Support Pads angles can be formed by adjusting the plates in the pad.

4.2 PREMIUM PAD COVER MATERIAL

- You may make one selection per column.
- Choose pad firmness and size in 4.1.
- Choose a cover material in 4.2.

GlideWear technology

FOR SKIN PROTECTION & SHEAR REDUCTION. NOT FLUID RESISTANT.

COMFORT-TEK

FOR FLUID PROTECTION & AN EASILY CLEANED SURFACE.

STRETCH-AIR

FOR COMFORT.

	GlideWear (GLIDEWEAR) (add \$26.00)
	COMFORT-TEK (COMFORT-TEK)
	STRETCH-AIR (STRETCH-AIR)

4.3 PT HARDWARE

- You may make one selection per column.
- Choose PT hardware type in 4.3 A or B.
- If choosing A, select a stem size immediately after.

RANGE OF MOTION

PT MODEL	TOTAL # OF LINKS	TOTAL LINK LENGTH	MAX ANTERIOR REACH	MAX POSTERIOR REACH	MAX LATERAL REACH
MID 6	2	6"	5.5"	1"	N/A
LAT 6	3	6"	5.5"	1"	6"
MID 8	2	8"	7.5"	1"	N/A
LAT 8	3	8"	7.5"	1"	8"
MAX 8	4	8"	7.5"	3"	8"

A. PT HARDWARE, REMOVABLE

HCPCS E1028

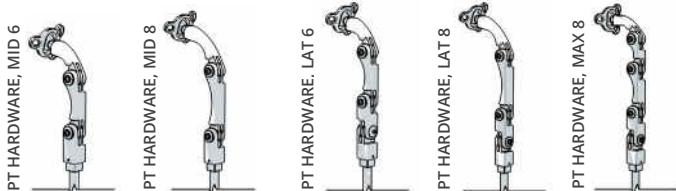

SHAPE	MSRP	PART NUMBER
MID 6	\$223.00	(BL-HS-PT1RMMID6)
LAT 6	\$260.00	(BL-HS-PT1RMLAT6)
MID 8	\$223.00	(BL-HS-PT1RMMID8)
LAT 8	\$260.00	(BL-HS-PT1RMLAT8)
MAX 8*	\$327.00	(BL-HS-PT1RMMAX8)

*Provides the greatest amount of articulation and range of motion.

PT HARDWARE, REMOVABLE, STEM LENGTH OPTION

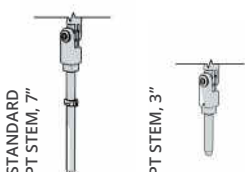

STEM LENGTH	MSRP	PART NUMBER
STANDARD 7" STEM	\$0.00	(HS-STEM-7)
**3" STEM	\$0.00	(HS-STEM-3)

**3" Stem is recommended for use with power mounting where there may be special constraints with power chair functions.

B. PT HARDWARE, FLIP-DOWN

HCPCS E1028

Flip-Down Hardware has 7" Stem

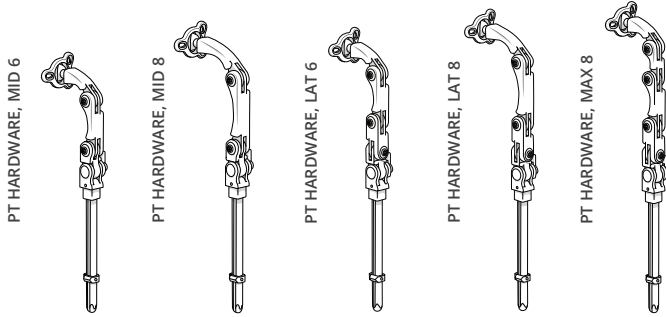

SHAPE	MSRP	PART NUMBER
MID 6	\$273.00	(BL-HS-PT1FDMID6)
LAT 6	\$310.00	(BL-HS-PT1FDLAT6)
MID 8	\$273.00	(BL-HS-PT1FDMID8)
LAT 8	\$310.00	(BL-HS-PT1FDLAT8)
MAX 8*	\$357.00	(BL-HS-PT1FDMAX8)

*Provides the greatest amount of articulation and range of motion.

4.4 HEAD SUPPORT MOUNTING OPTION



MOUNTING BLOCK-POSTERIOR A

MOUNTING BLOCK OR BRACKET	MSRP	PART NUMBER
POSTERIOR A MOUNTING BLOCK	\$0.00	(HS-MB-POSTA)

4.5 EXTRA HARDWARE



LINK LENGTH	MSRP	EXTRA PART
*EXTRA 2" LINK	\$57.00	(BL-HS-PT1LINK2)



*EXTRA 3" LINK	\$57.00	(BL-HS-PT1LINK3)
----------------	---------	------------------



*EXTRA 4" LINK	\$57.00	(BL-HS-PT1LINK4)
----------------	---------	------------------



TOOL-LESS WING LOCK	MSRP	EXTRA PART	EXTRA PART	EXTRA PART	EXTRA PART
*1 LOCK	\$21.00/each	(BL-HS-52WINGA1)	(BL-HS-52WINGA1)	(BL-HS-52WINGA1)	(BL-HS-52WINGA1)



ADDITIONAL	MSRP	EXTRA PART
1/4" SPACER PLATE	\$37.00/each	(BL-HS-SPCRA)

*FOR PT HARDWARE ONLY

The following are trademarks and registered trademarks of Permobil Seating and Positioning: ACTA-BACK®, BodiLink®, COMFORT-TEK®, Compass®, and STRETCH-AIR®. GlideWear™ is a trademark of MIPS.