

ACTA-RELIEF LTS Back Support Order Form



SEATING + POSITIONING

HCPCS CODING: E2620
POSITIONING BACK, PLANAR WITH LATERAL SUPPORTS

Since U.S. Medicare coding is subject to change, the provider should always confirm the HCPCS code and coverage criteria as part of the client assessment process.



Shown with Compass® 4 Quick Release 2 Point Hardware.
Cover appearance may vary with hardware selection.

Company Name/ACCT #: _____

P.O. Number: _____

Requested By: _____

Phone: _____ Fax: _____

Email: _____

Ship To: _____

Client Reference: _____

DO NOT SEND PROTECTED HEALTH INFORMATION. IT IS NOT NEEDED TO MAKE THE PRODUCT YOU ARE REQUESTING.

1 SIZE SELECTION Required

BASE MSRP*

LENGTH*	22"	\$937.00			
	20"				
	18"				
	16"				
	14"				
	12"				
	14"	16"	18"	20"	
	FRAME WIDTH				

Sizes available are subject to hardware being used.

ARLTS-BS

Please fill in one of the above with dimensions from the size charts to the right.
Example Part: **ARLTS-BS14W16L**

Hardware will be selected in Section 2.

*Length (L) refers to the actual size dimension of the support from bottom to top edge.

Sizes available with 2 POINT Mounting Hardware

LENGTH*	22"	14W22L	16W22L	18W22L	20W22L
	20"	14W20L	16W20L	18W20L	20W20L
	18"	14W18L	16W18L	18W18L	20W18L
	16"	14W16L	16W16L	18W16L	20W16L
	14"	14W14L	16W14L	18W14L	20W14L
	12"	14W12L	16W12L	18W12L	20W12L
	14"	16"	18"	20"	
	FRAME WIDTH				

Sizes available with 4 POINT Mounting Hardware

LENGTH*	22"	14W22L	16W22L	18W22L	20W22L
	20"	14W20L	16W20L	18W20L	20W20L
	18"	14W18L	16W18L	18W18L	20W18L
	16"	14W16L	16W16L	18W16L	20W16L
	14"	14W14L	16W14L	18W14L	20W14L
	12"				
	14"	16"	18"	20"	
	FRAME WIDTH				

Sizes available with POWER Mounting Hardware

LENGTH*	22"	14W22L	16W22L	18W22L	20W22L
	20"	14W20L	16W20L	18W20L	20W20L
	18"	14W18L	16W18L	18W18L	20W18L
	16"	14W16L	16W16L	18W16L	20W16L
	14"	14W14L	16W14L	18W14L	20W14L
	12"	14W12L	16W12L	18W12L	20W12L
	14"	16"	18"	20"	
	FRAME WIDTH				

2 COVER & HARDWARE SELECTION

Required

2.1 COVER SELECTION

MSRP \$0.00

Both fabrics are made without latex. Fabric selection is for the support surface only. Other fabrics used in cover construction remain the same.



COMFORT-TEK® is a smooth, easily cleaned surface. The fluid protection aids in infection control.



STRETCH-AIR® has comfortable stretch, air transmission and heat dissipation. It is not fluid resistant.

COMFORT-TEK Cover
(COMFORT-TEK)

STRETCH-AIR Cover
(STRETCH-AIR)

2.2 HARDWARE STYLE

COMPASS 4 QUICK RELEASE

Price included in back support purchase

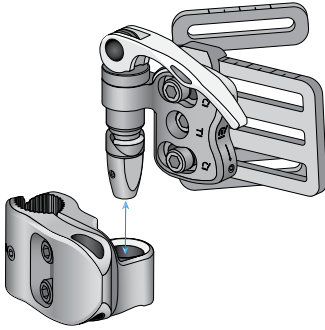

QUICK RELEASE 2 POINT
(Q-COMPASS)

QUICK RELEASE 4 POINT
(Q-COMPASS4)

4 POINT hardware is required on all 24"W back supports using Compass 4 hardware.

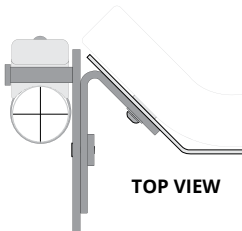

COMPASS 4 FIXED

Price included in back support purchase

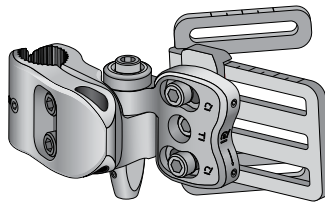

FIXED fully adjustable hardware requires tools for back support removal

FIXED 2 POINT
(NQ-COMPASS)

FIXED 4 POINT
(NQ-COMPASS4)

COMPASS POWER MOUNT

MSRP add \$40.00

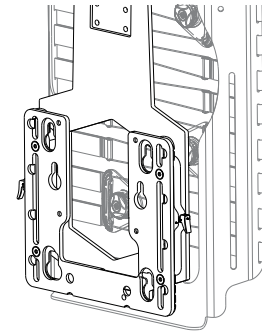

POWER MOUNT hardware has 8" of height adjustment in 1/2" increments without using tools.

QUANTUM w/ TRU BALANCE 3
(PMB-QUANTUM)

PERMOBIL w/ CORPUS 3G
(PMB-PERMOBIL)

QUICKIE w/ 3.7 POWER
(PMB-QUICKIE)

AVID REHAB w/ POWER T & R
(PMB-AVID)

ROVI w/ MOTION CONCEPTS*
(PMB-ROVI)

*Using Power Mount Hardware on ROVI requires mounting to the RECESSED PLANAR INTERFACE PLATE available when ordering the Motion Concepts Seating System. Drilling is required for mounting.

3 LATERAL TRUNK SUPPORT SELECTION

3.1 Required (3.2 Optional)

3.1 LATERAL TRUNK SUPPORT

Price included in back support purchase

Length (L) refers to the actual size dimension of the support from top to bottom edge.
Depth (D) refers to the actual size dimension of the support from anterior to posterior edge.

- LTS back supports come with moldable supports and fixed mounting hardware.
- Hardware is width and depth adjustable. Height adjustable on back support shell. Adjustments require tools.

MOLDABLE SUPPORT **FIXED HARDWARE**

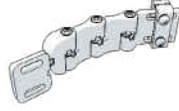
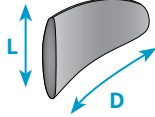

Size	Cover Style	
3" L x 4" D	COMFORT-TEK (LAT-3L4D-COMFORT-TEK)	
	STRETCH-AIR (LAT-3L4D-STRETCH-AIR)	
4" L x 5" D	COMFORT-TEK (LAT-4L5D-COMFORT-TEK)	
	STRETCH-AIR (LAT-4L5D-STRETCH-AIR)	
4" L x 6.5" D	COMFORT-TEK (LAT-4L6D-COMFORT-TEK)	
	STRETCH-AIR (LAT-4L6D-STRETCH-AIR)	
5" L x 6.5" D	COMFORT-TEK (LAT-5L6D-COMFORT-TEK)	
	STRETCH-AIR (LAT-5L6D-STRETCH-AIR)	

COMFORT-TEK
Smooth, easily cleaned surface. The fluid protection aids in infection control.

STRETCH-AIR
For comfort and heat dissipation.

3.2 ADDITIONAL LATERAL TRUNK SUPPORT HARDWARE

SWING-AWAY HARDWARE

HCPCS Code: E1028
MSRP \$298.00/ea.

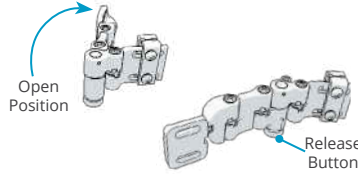

LEFT		*EXTRA LEFT	
	BL-LTS-GT2SAK-LH		BL-LTS-GT2SAK-LH
RIGHT		*EXTRA RIGHT	
	BL-LTS-GT2SAK-RH		BL-LTS-GT2SAK-RH

Hardware is width and depth adjustable. Height adjustable on back support shell. Adjustments require tools.

*"EXTRA" parts may not fit depending on back support, pad, and hardware size and style combinations.

EXTRA HARDWARE LINKS



LEFT		ADD'L LEFT	
	BL-LTS-GT2LINK		BL-LTS-GT2LINK
RIGHT		ADD'L RIGHT	
	BL-LTS-GT2LINK		BL-LTS-GT2LINK

HARDWARE COVER

MSRP \$27.00/ea



LEFT		EXTRA LEFT	
	BL-LTS-HCOVER		BL-LTS-HCOVER
RIGHT		EXTRA RIGHT	
	BL-LTS-HCOVER		BL-LTS-HCOVER

4 BACK SUPPORT ADD-ON SELECTIONS

Optional

4.1 PRIVACY FLAP

MSRP \$37.00

This flap connects with hook & loop attachment between the seat and back for added privacy.

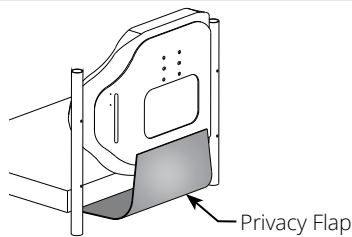

PRIVACY FLAP (PV-FLAP)

5 BODILINK HEAD SUPPORT HARDWARE & PADS

- You may make one selection per column.
- Choose pad firmness and size in 5.1.
- Choose a cover material in 5.2.

5.1 PREMIUM PAD SIZE

HCPCS CODING: E0955 MSRP \$237.00

Length (L) refers to the actual size dimension of the support from bottom to top edge.

		Pad Firmness	
L	6W x 3L	Soft	BL-HSP1-6W3L
		Extra Soft	BL-HSP2-6W3L
L	8W x 4L	Soft	BL-HSP1-8W4L
		Extra Soft	BL-HSP2-8W4L
L	10W x 5L <i>with adjustable wings</i>	Soft	BL-HSP1-10W5L
		Extra Soft	BL-HSP2-10W5L
L	12W x 5L <i>with adjustable wings</i>	Soft	BL-HSP1-12W5L
		Extra Soft	BL-HSP2-12W5L
L	14W x 5L <i>with adjustable wings</i>	Soft	BL-HSP1-14W5L
		Extra Soft	BL-HSP2-14W5L
L	18W x 5L <i>with adjustable wings</i>	Soft	BL-HSP1-18W5L
		Extra Soft	BL-HSP2-18W5L



Premium Head Support Pads angles can be formed by adjusting the plates in the pad.

5.2 PREMIUM PAD COVER MATERIAL

GlideWear™ technology

FOR SKIN PROTECTION & SHEAR REDUCTION. NOT FLUID RESISTANT

COMFORT-TEK®

FOR FLUID PROTECTION & AN EASILY CLEANED SURFACE.



STRETCH-AIR

FOR COMFORT.



	GlideWear™ (GLIDEWEAR) (add \$26.00)
	Comfort-Tek (COMFORT-TEK)
	Stretch-Air (STRETCH-AIR)

5.3 PT HARDWARE

- You may make one selection per column.
- Choose PT hardware type in 5.3 A or B.
- If choosing A, select a stem size immediately after.

RANGE OF MOTION

PT MODEL	TOTAL # OF LINKS	TOTAL LINK LENGTH	MAX ANTERIOR REACH	MAX POSTERIOR REACH	MAX LATERAL REACH
MID 6	2	6"	5.5"	1"	N/A
LAT 6	3	6"	5.5"	1"	6"
MID 8	2	8"	7.5"	1"	N/A
LAT 8	3	8"	7.5"	1"	8"
MAX 8	4	8"	7.5"	3"	8"

A. PT HARDWARE, REMOVABLE

HCPCS E1028

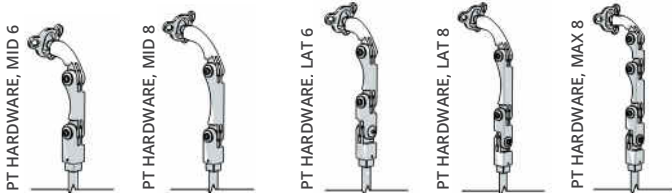

SHAPE	MSRP	PART NUMBER
MID 6	\$223.00	(BL-HS-PT1RMMID6)
LAT 6	\$260.00	(BL-HS-PT1RMLAT6)
MID 8*	\$223.00	(BL-HS-PT1RMMID8)
LAT 8*	\$260.00	(BL-HS-PT1RMLAT8)
MAX 8**	\$327.00	(BL-HS-PT1RMMAX8)

- *Recommended for Acta-Relief® back supports. See options for mounting hardware selections.
- **Provides the greatest amount of articulation and range of motion.

PT HARDWARE, REMOVABLE, STEM LENGTH OPTION

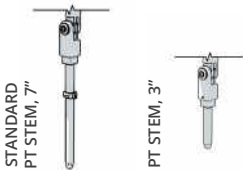

STEM LENGTH	MSRP	PART NUMBER
STANDARD 7" STEM	\$0.00	(HS-STEM-7)
***3" STEM	\$0.00	(HS-STEM-3)

- ***3" Stem is recommended for use with power mounting where there may be special constraints with power chair functions.

B. PT HARDWARE, FLIP-DOWN

HCPCS E1028

Flip-Down Hardware has 7" Stem

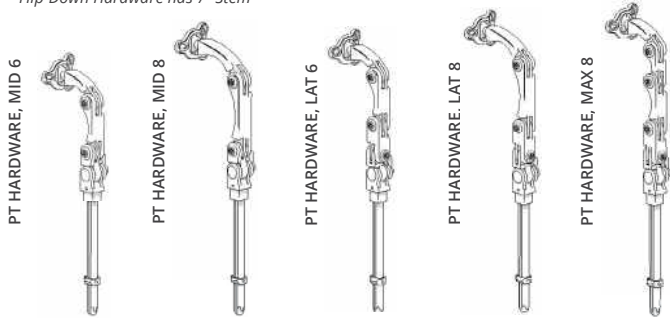

SHAPE	MSRP	PART NUMBER
MID 6	\$273.00	(BL-HS-PT1FDMID6)
LAT 6	\$310.00	(BL-HS-PT1FDLAT6)
MID 8*	\$273.00	(BL-HS-PT1FDMID8)
LAT 8*	\$310.00	(BL-HS-PT1FDLAT8)
MAX 8**	\$357.00	(BL-HS-PT1FDMAX8)

*Recommended for Acta-Relief® back supports. See options for mounting hardware selections.
 **Provides the greatest amount of articulation and range of motion.

5.4 HEAD SUPPORT MOUNTING OPTION



BRACKET WITH MOUNTING BLOCK- ACTA-RELIEF 18W Shown Above For Non-Power Mount Only.



MOUNTING BLOCK- POSTERIOR A For Acta-Relief with Power Mount Only

MOUNTING BLOCK OR BRACKET WITH MOUNTING BLOCK	MSRP	PART NUMBER
*ACTA-RELIEF 14W BRACKET WITH MOUNTING BLOCK	\$72.00	(HS-MB-AR14W)
*ACTA-RELIEF 16W BRACKET WITH MOUNTING BLOCK	\$72.00	(HS-MB-AR16W)
*ACTA-RELIEF 18W BRACKET WITH MOUNTING BLOCK	\$72.00	(HS-MB-AR18W)
*ACTA-RELIEF 20W BRACKET WITH MOUNTING BLOCK	\$72.00	(HS-MB-AR20W)
POSTERIOR A MOUNTING BLOCK	\$0.00	(HS-MB-POSTA)

*For Acta Relief, includes mounting bracket and POSTA block.
 If you already have an Acta-Relief head support bracket, order POSTA Block

5.5 EXTRA HARDWARE

LINK LENGTH	MSRP	EXTRA PART
*EXTRA 2" LINK	\$57.00	(BL-HS-PT1LINK2)

*EXTRA 3" LINK	\$57.00	(BL-HS-PT1LINK3)
----------------	---------	------------------

*EXTRA 4" LINK	\$57.00	(BL-HS-PT1LINK4)
----------------	---------	------------------

TOOL-LESS WING LOCK	MSRP	EXTRA PART	EXTRA PART	EXTRA PART	EXTRA PART
*1 LOCK	\$21.00/each	(BL-HS-52WINGA1)	(BL-HS-52WINGA1)	(BL-HS-52WINGA1)	(BL-HS-52WINGA1)

ADDITIONAL	MSRP	EXTRA PART
1/4" SPACER PLATE	\$37.00/each	(BL-HS-SPCRA)

*FOR PT HARDWARE ONLY

BRACKET SIZE	MSRP	PART NUMBER
*ACTA-RELIEF™ 14W BRACKET	\$152.00	(BL-HS-AR14W)
*ACTA-RELIEF™ 16W BRACKET	\$152.00	(BL-HS-AR16W)
*ACTA-RELIEF™ 18W BRACKET	\$152.00	(BL-HS-AR18W)
*ACTA-RELIEF™ 20W BRACKET	\$152.00	(BL-HS-AR20W)

*Bracket only, does not include mounting block.

ADDITIONAL	MSRP	EXTRA PART
1/4" SPACER PLATE	\$37.00/each	(BL-HS-SPCRA)



BRACKET- ACTA-RELIEF 18W Shown Above



The following are trademarks and registered trademarks of Permobil Seating and Positioning: BodiLink®, COMFORT-TEK®, Compass®, and STRETCH-AIR®. GlideWear™ is a trademark of MIPS.