

Vicair® Vector O2 ORDER FORM

HCPCS CODING: E2624/E2625
ADJUSTABLE SKIN PROTECTION & POSITIONING

permobil

SEATING + POSITIONING



Vector O2

Company Name/ACCT #: _____

P.O. Number: _____

Requested By: _____

Phone: _____ Fax: _____

Email: _____

Ship To: _____

Client Reference: _____

DO NOT SEND PROTECTED HEALTH INFORMATION. IT IS NOT NEEDED TO MAKE THE PRODUCT YOU ARE REQUESTING.

1 SIZE & STYLE

INCOTEC
FOR FLUID PROTECTION &
AN EASILY CLEANED SURFACE.

OR

COMFAIR
FOR USER COMFORT
& HEAT DISSIPATION.

Choose the fabric type and size for the Vector O2 Standard Profile. If a Kwik Strap is needed, choose a size on page 2.

VECTOR O2

HCPCS CODE: E2624/E2625

 = Nonstock items available at extended lead times and a \$40.00 upcharge

		INCOTEC												
		\$476.00					\$525.00							
DEPTH	22"													
	21"													
	20"													
	19"													
	18"													
	17"													
	16"													
	15"													
	14"													
		14"	15"	16"	17"	18"	19"	20"	22"	24"				

		COMFAIR											
		\$476.00					\$525.00						
DEPTH	22"												
	21"												
	20"												
	19"												
	18"												
	17"												
	16"												
	15"												
	14"												
		14"	15"	16"	17"	18"	19"	20"	22"	24"			

Choose the size needed for the Vector O2 with Kwik Strap. If no Kwik Strap is needed, choose a size and fabric for Vector O2 Standard Profile on page 1.

VECTOR O2 WITH KWIK STRAP

		INCOTEC				
		\$486.00			\$535.00	
DEPTH	20"	OVRS-CI-1620-KS	OVRS-CI-1820-KS	OADS-CI-2020-KS	OVRS-CI-2220-KS	OVRS-CI-2420-KS
	18"	OVRS-CI-1618-KS	OVRS-CI-1818-KS	OADS-CI-2018-KS	OVRS-CI-2218-KS	OVRS-CI-2418-KS
	16"	OVRS-CI-1616-KS	OVRS-CI-1816-KS	OADS-CI-2016-KS		
		16"	18"	20"	22"	24"
		WIDTH				

2 VECTOR O2 ACCESSORIES

2.1 REMOVABLE SOLID SEAT PAN & HARDWARE KIT HCPCS Code: E2231 MSRP \$387.00

The solid seat pan kit includes a slotted aluminum pan and attaching hardware to accommodate 7/8" or 1" tubing. The kit also comes with two different cross bars to accommodate various wheelchair frame types. This will fit both folding and non-folding seat rails. Lateral thigh support hardware can be easily attached.



Solid Seat Pan & Hardware Kit
(RSSP-1-___)

2.2 EXTRA VICAIR® AIR CELLS MSRP \$43.00 / 50 air cell pack



Pack of 50 Vicair® Air Cells (AIRCELL50)

3 BODILINK® LATERAL PELVIC/THIGH SUPPORT HARDWARE & PADS

Please select sizes in the appropriate fabric & style charts below. Contact Customer Support for custom sizes that are not listed below

3.1 PREMIUM PAD SIZE & SHAPE HCPCS Code: E0953 MSRP \$62.00

- You may make one selection per column (Left, Extra Left, Right, and Extra Right) in section 3.1.
- Make a fabric selection in 3.2.

*Length (L) refers to the actual size dimension of the support from top to bottom edge. Depth (D) refers to the actual size dimension from anterior to posterior edge.

STYLE	SIZE	LEFT	EXTRA LEFT	RIGHT	EXTRA RIGHT
	3.5" L x 4" D	BL-LPTSP2Z-3L4D-LH	BL-LPTSP2Z-3L4D-LH	BL-LPTSP2Z-3L4D-RH	BL-LPTSP2Z-3L4D-RH
	3.5" L x 8" D	BL-LPTSP2Z-3L8D-LH	BL-LPTSP2Z-3L8D-LH	BL-LPTSP2Z-3L8D-RH	BL-LPTSP2Z-3L8D-RH
	3.5" L x 12" D	BL-LPTSP2Z-3L12D-LH	BL-LPTSP2Z-3L12D-LH	BL-LPTSP2Z-3L12D-RH	BL-LPTSP2Z-3L12D-RH
	5.5" L x 6" D	BL-LPTSP2Z-5L6D-LH	BL-LPTSP2Z-5L6D-LH	BL-LPTSP2Z-5L6D-RH	BL-LPTSP2Z-5L6D-RH

3.2 PREMIUM PAD COVER WITH FOAM INSERT

COVER OPTIONS	MSRP	LEFT		EXTRA LEFT		RIGHT		EXTRA RIGHT	
COMFORT-TEK®	\$0.00/ea.		LPTS-P2-COMFORT-FM		LPTS-P2-COMFORT-FM		LPTS-P2-COMFORT-FM		LPTS-P2-COMFORT-FM
STRETCH-AIR®	\$0.00/ea.		LPTS-P2-STRETCH-FM		LPTS-P2-STRETCH-FM		LPTS-P2-STRETCH-FM		LPTS-P2-STRETCH-FM
GLIDEWEAR®	\$13.00/ea.		LPTS-P2-GLIDE-FM		LPTS-P2-GLIDE-FM		LPTS-P2-GLIDE-FM		LPTS-P2-GLIDE-FM

COMFORT-TEK®
FOR FLUID PROTECTION & AN EASILY CLEANED SURFACE.

STRETCH-AIR®
FOR USER COMFORT & HEAT DISSIPATION.

GlideWear®
FOR SKIN PROTECTION & SHEAR REDUCTION.
NOT FLUID RESISTANT.

• You may make one selection per column (Left, Extra Left, Right, and Extra Right) in section 3.3 from group A, B, or C.
• TT long extension arms (section 3.4) will only work with TT style hardware.

3.3 BODILINK® LATERAL PELVIC/THIGH SUPPORT HARDWARE

A. TT HARDWARE, SLOT MOUNT

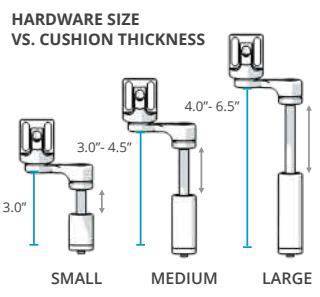

HARDWARE SIZE	MAX CUSHION THICKNESS CLEARANCE	RECOMMENDED CUSHION THICKNESS
SMALL	3.0"	2.0"- 3.0"
MEDIUM	4.5"	3.0"- 4.5"
LARGE	6.5"	4.0"- 6.5"

FIXED	SIZE	MSRP	LEFT		EXTRA LEFT		RIGHT		EXTRA RIGHT	
	SMALL	\$141.00		BL-LPTS-TT1FXSL1-LH		BL-LPTS-TT1FXSL1-LH		BL-LPTS-TT1FXSL1-RH		BL-LPTS-TT1FXSL1-RH
MEDIUM	\$141.00		BL-LPTS-TT1FXSL2-LH		BL-LPTS-TT1FXSL2-LH		BL-LPTS-TT1FXSL2-RH		BL-LPTS-TT1FXSL2-RH	
LARGE	\$141.00		BL-LPTS-TT1FXSL3-LH		BL-LPTS-TT1FXSL3-LH		BL-LPTS-TT1FXSL3-RH		BL-LPTS-TT1FXSL3-RH	
REMOVABLE E1028	SIZE	MSRP	LEFT		EXTRA LEFT		RIGHT		EXTRA RIGHT	
	SMALL	\$248.00		BL-LPTS-TT1RMSL1-LH		BL-LPTS-TT1RMSL1-LH		BL-LPTS-TT1RMSL1-RH		BL-LPTS-TT1RMSL1-RH
	MEDIUM	\$248.00		BL-LPTS-TT1RMSL2-LH		BL-LPTS-TT1RMSL2-LH		BL-LPTS-TT1RMSL2-RH		BL-LPTS-TT1RMSL2-RH
LARGE	\$248.00		BL-LPTS-TT1RMSL3-LH		BL-LPTS-TT1RMSL3-LH		BL-LPTS-TT1RMSL3-RH		BL-LPTS-TT1RMSL3-RH	

B. TT HARDWARE, POWER MOUNT

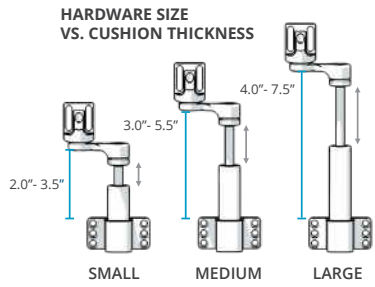

HARDWARE SIZE	MAX CUSHION THICKNESS CLEARANCE	RECOMMENDED CUSHION THICKNESS
SMALL	3.5"	2.0"- 3.5"
MEDIUM	5.5"	3.0"- 5.5"
LARGE	7.5"	4.0"- 7.5"

FIXED	SIZE	MSRP	LEFT		EXTRA LEFT		RIGHT		EXTRA RIGHT	
	SMALL	\$185.00		BL-LPTS-TT1FXPWL1-LH		BL-LPTS-TT1FXPWL1-LH		BL-LPTS-TT1FXPWL1-RH		BL-LPTS-TT1FXPWL1-RH
	MEDIUM	\$185.00		BL-LPTS-TT1FXPWL2-LH		BL-LPTS-TT1FXPWL2-LH		BL-LPTS-TT1FXPWL2-RH		BL-LPTS-TT1FXPWL2-RH
LARGE	\$185.00		BL-LPTS-TT1FXPWL3-LH		BL-LPTS-TT1FXPWL3-LH		BL-LPTS-TT1FXPWL3-RH		BL-LPTS-TT1FXPWL3-RH	
REMOVABLE E1028	SIZE	MSRP	LEFT		EXTRA LEFT		RIGHT		EXTRA RIGHT	
	SMALL	\$285.00		BL-LPTS-TT1RMPWL1-LH		BL-LPTS-TT1RMPWL1-LH		BL-LPTS-TT1RMPWL1-RH		BL-LPTS-TT1RMPWL1-RH
	MEDIUM	\$285.00		BL-LPTS-TT1RMPWL2-LH		BL-LPTS-TT1RMPWL2-LH		BL-LPTS-TT1RMPWL2-RH		BL-LPTS-TT1RMPWL2-RH
LARGE	\$285.00		BL-LPTS-TT1RMPWL3-LH		BL-LPTS-TT1RMPWL3-LH		BL-LPTS-TT1RMPWL3-RH		BL-LPTS-TT1RMPWL3-RH	

TT HARDWARE, POWER MOUNT OPTION

NOTE: If choosing the Power Mount Hardware, choose the appropriate power mount type below.

POWER MOUNT	MSRP	PART NUMBER
QUANTUM	add \$0.00	LPTS-TT1-PW1
PERMOBIL	add \$0.00	LPTS-TT1-PW2
QUICKIE	add \$0.00	LPTS-TT1-PW3
ROVI	add \$0.00	LPTS-TT1-PW4
AVID REHAB	add \$0.00	LPTS-TT1-PW5

3.4 TT LONG EXTENSION ARM 4" MSRP \$37.00/arm

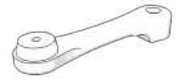

LEFT	EXTRA LEFT	RIGHT	EXTRA RIGHT
BL-LPTS-TT1LARM4	BL-LPTS-TT1LARM4	BL-LPTS-TT1LARM4	BL-LPTS-TT1LARM4

4 BODILINK® MEDIAL KNEE/THIGH SUPPORT HARDWARE & PADS

4.1 PAD SIZE & SHAPE

HCPCS CODING: E0957 MSRP \$130.00

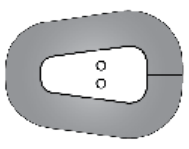
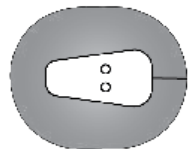
STYLE	SIZE	PART NUMBER
 WEDGE	2.5"W x 3.5"D	BL-MKTSP1-3W4D
	3.5"W x 5"D	BL-MKTSP1-4W5D
	4"W x 6"D	BL-MKTSP1-4W6D
 OVAL	2.5"W x 3.5"D	BL-MKTSP2-3W4D
	3.5"W x 5"D	BL-MKTSP2-4W5D
	5"W x 6"D	BL-MKTSP2-5W6D

- You may make one selection per column.
- Choose between wedge or oval in 4.1.
- Choose a cover material in 4.2.
- Choose hardware size in 4.3.

4.2 PAD COVER MATERIAL

 COMFORT-TEK®	FOR SKIN PROTECTION & SHEAR REDUCTION. NOT FLUID RESISTANT.
 STRETCH-AIR®	FOR FLUID PROTECTION & AN EASILY CLEANED SURFACE.
 STRETCH-AIR®	FOR USER COMFORT & HEAT DISSIPATION.

GlideWear® (MKTSP-GLIDE) (add \$15.00)
Comfort-Tek® (MKTSP-COMFORT)
Stretch-Air® (MKTSP-STRETCH)

4.3 MEDIAL KNEE/THIGH SUPPORT SWING AWAY HARDWARE

HCPCS CODING: E1028 MSRP \$180.00

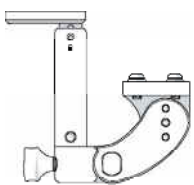

SIZE	PART NUMBER
SMALL	BL-MKTS-ST1SASL1
MEDIUM	BL-MKTS-ST1SASL2
LARGE	BL-MKTS-ST1SASL3

*Swing Away Hardware only, not available in Fixed Hardware
 **MKTS Hardware must be mounted to Removable Solid Seat Pan in section 2.4
 ***If Leg Length Discrepancy is needed on Removable Solid Seat Pan, Offset Orientation must be selected

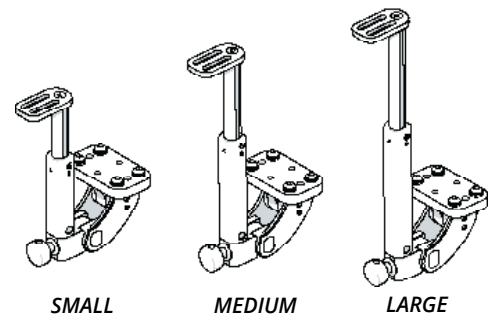
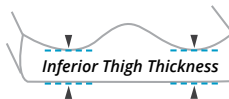

SIZE	RECOMMENDED INFERIOR THIGH THICKNESS
Small	1.00" - 3.00"
Medium	2.00" - 5.00"
Large	3.00" - 7.00"