

INSTRUCTION MANUAL

for the AccuRelief Ultimate Foot Circulator



This manual is valid for the AccuRelief Ultimate Foot Circulator

This instruction manual is published by Carex Health Brands. Carex Health Brands reserves the right to improve and amend it at any time without prior notice. Amendments may however be published in new editions of this manual.

All Rights Reserved.Rev.V1.5 © 2014, 20140828

INTRODUCTION

Thank you for purchasing the AccuRelief Ultimate Foot Circulator for stimulation in your feet & lower legs.

In order to use the device safely, please read the complete manual carefully before using the device for the first time.

Keep this instruction manual in a convenient place or store with the device for future reference.

The essential performance of the device is free from the production of unwanted or excessive stimulation output.

INDICATIONS FOR USE



The AccuRelief Ultimate Foot Circulator is intended to stimulate muscles of the lower extremity in order to temporarily increase local blood circulation and to facilitate and improve muscle performance.

Conformity to safety standards

Carex Health Brands declares that the device complies with the following normative documents:

IEC60601-1, IEC60601-1-2, IEC60601-2-10, IEC62366,
IEC60601-1-11, ISO10993-5, ISO10993-10, ISO10993-1, ISO7010

TABLE OF CONTENTS



INTRODUCTION.....	2
INDICATIONS FOR USE	2
IMPORTANT SAFETY PRECAUTIONS AND WARNINGS.....	4
EXPLANATION OF THE ACCURELIEF ULTIMATE FOOT CIRCULATOR.....	8
FEATURES	9
ADAPTOR	10
BATTERY	10
DIRECTIONS FOR USE	12
Foot and Leg Stimulation ().....	12
Body Stimulation ().....	14
Stepper Function.....	16
SPECIFICATION	17
PROGRAM.....	18
ELECTRODE PLACEMENT GUIDE.....	19
ACCURELIEF™ PAD PLACEMENT GUIDE	20
FAQ'S.....	21
CLEANING AND STORAGE	23
TROUBLESHOOTING	25
DISPOSAL.....	27
GLOSSARY OF SYMBOLS.....	27
WARRANTY	28
IMPORTANT INFORMATION REGARDING ELECTRO MAGNETIC COMPATIBILITY (EMC).....	29

IMPORTANT SAFETY PRECAUTIONS AND WARNINGS



It is important that you read all the warnings and precautions included in this manual because they are intended to keep you safe, prevent injury and avoid a situation that could result in damage to the device.

SAFETY SYMBOLS USED IN THIS MANUAL

 DANGER	Indicates a potentially hazardous situation which, if not avoided, could result in death or serious injury.
 WARNING	Indicates a potentially hazardous situation which, if not avoided, could result in serious injury and equipment damage.
 CAUTION	Indicates a potentially hazardous situation which, if not avoided, may result in minor or moderate injury to the user or patient, or damage to the device or other property.

DANGER

This stimulator must not be used in combination with the following medical devices:

- Internally transplanted electronic medical devices, such as a pacemaker.
- Electronic life support equipment, such as respirators.
- Electronic medical devices attached to the body, such as electrocardiographs.

Using this stimulator with other electronic medical devices may cause erroneous operation of those devices.



WARNING

DO NOT USE THIS DEVICE UNDER THESE CONDITIONS:

- Consult with your physician before using this device, because the device may cause lethal rhythm disturbances in certain susceptible individuals.
- If you have a cardiac pacemaker, implanted defibrillator, or other implanted metallic or electronic device, such use could cause electric shock, burns, electrical interference, or death.
- Together with a life-supporting medical electronic device, such as an artificial heart or lung or respirator.
- In the presence of electronic monitoring equipment (e.g., cardiac monitors, ECG alarms), which may not operate properly when the electrical stimulation device is in use.

- On open wounds or rashes, or over swollen, red, infected, or inflamed areas or skin eruptions (e.g., phlebitis, thrombophlebitis, varicose veins); or on top of, or in proximity to, cancerous lesions.
- Over areas of skin that lack normal sensation.
- On the opposite sides of your head, since the effects of stimulation of the brain are unknown.
- Do not operate two or more Ultimate Foot Circulators at the same time in the same barrier-free space, unless the distance between two devices exceed 32ft.

DO NOT USE ON THESE INDIVIDUALS

- Pregnant women, because the safety of electrical stimulation during pregnancy has not been established.
- Children or infants, because the device has not been evaluated for pediatric use.
- Persons incapable of expressing their thoughts or intentions.
- The long-term effects of electrical stimulation are unknown.

DO NOT USE THIS DEVICE DURING THESE ACTIVITIES

- When in the bath or shower;
- While sleeping;
- While driving, operating machinery, or during any activity in which electrical stimulation can put you at risk for injury.

WARNINGS AND PRECAUTIONS REGARDING THE PADS

- Apply pads to normal, healthy, dry, clean skin (of adult patients) because it may otherwise disrupt the healing process.
- If you experience any skin irritation or redness after a session, do not continue stimulation in that area of the skin.

NEVER APPLY THE PADS TO:

- The head or any area of the face.
- The neck or any area of the throat because this could cause severe muscle spasms resulting in closure of the airway, difficulty in breathing, or adverse effects on heart rhythm or blood pressure.
- Both sides of the thorax simultaneously (lateral or front and back), or across your chest because the introduction of electrical current may cause rhythm disturbances which could be lethal.





CAUTION

WARNINGS AND PRECAUTIONS REGARDING THE PADS

- Do not bend or fold because the pad may not function properly. Place the pads onto the plastic film and then store into the sealed package when not in use.
- Do not apply ointment or any solvent to the pads or to your skin because it will disrupt the pads from functioning properly.
- The pads are already pre-gelled and will adhere to your skin.
- To avoid damage to the adhesive surface of the pads, put the pads only on the skin or on the plastic film provided.
- Place the pads at least 1 ½" apart on your skin. The pads should never touch each other.
- Always place clean pads in accordance with illustrations provided (Refer to page 20).
- Make sure the components are connected well and the pads are fixed on the part of the body you wish to treat or the therapy may not be effective.

DO NOT USE YOUR PADS THIS WAY

- **Pads should not be placed simultaneously on the calves of both legs.**



Pads should not touch each other when placed onto your skin.

- Do not place on your spine or backbone.
- Pad should not touch any metal object, such as a belt buckle or necklace.
- Do not share pads with another person. This may cause a skin irritation or infection. Pads are intended for use by one person.
- Do not place or relocate the pads while the device is on.
- Always turn the power off before removing or changing the pad location.
- Do not leave pads attached to the skin after treatment.

CAUTION WHILE USING THE STIMULATOR

- If the stimulator is not functioning properly or you feel discomfort, immediately stop using the device.
- Do not use for any other purpose except for what it is intended for.
- Do not insert the electrode plug into any place other than the jack on the main unit.
- Do not mix Alkaline and Rechargeable/Alkaline batteries as this will shorten the battery life.
- Do not pull on the electrode cord during treatment.
- Do not use the device while wearing electronic devices such as watches as this may damage the device.
- Do not use near a cell phone as this may cause the stimulator to malfunction.
- Do not bend or pull the end of the cord.
- When pulling out the cord from the device, hold the plug and pull.

- Replace the cord when broken or damaged.
- Do not throw the batteries into a fire. The batteries may explode.
- Dispose of the device, batteries, and components according to applicable legal regulations. Unlawful disposal may cause environmental pollution.
- The size, shape and type of pads may affect the safety and effectiveness of electrical stimulation.
- The electrical performance characteristics of pads may affect the safety and effectiveness of electrical stimulation.
- Using pads that are smaller than the pads included with device or incorrectly applied, could result in discomfort or skin burns.

GENERAL PRECAUTIONS

- Apply stimulation to only normal, intact, clean, dry, and healthy skin.
- You may experience skin irritation or hypersensitivity due to the electrical stimulation or electrical conductive medium (gel).
- If you have suspected or diagnosed heart disease, you should follow precautions recommended by your physician.
- If you have suspected or diagnosed epilepsy, you should follow precautions recommended by your physician.
- Use caution if you have a tendency to bleed internally, such as following an injury or fracture.
- Consult with your physician prior to using the device after a recent surgical procedure, because stimulation may disrupt the healing process.
- This stimulation should not be applied over the menstruating or pregnant uterus.
- This stimulation should not be applied over areas of skin that lack normal sensation.



Keep unit away from young children. The unit contains small pieces that may be swallowed.



Keep unit out of the reach of young children. The electrode cord can cause strangulation.

- Use this device only with the leads, electrodes, and accessories recommended by the manufacturer.

Possible Adverse Reactions

- Some patients may experience skin irritation or hypersensitivity due to the electrical stimulation or electrical conductive medium. The irritation can usually be reduced by using an alternate conductive medium, or alternate electrode placement.
- You should stop using the device and consult with your physician if you experience adverse reactions from the device.

EXPLANATION OF THE Ultimate Foot Circulator

The Ultimate Foot Circulator works by sending electronic pulses to the foot or body muscle through the foot pads and/or self-adhesive electrode pads. The physiological result is that the foot and calf muscles contract and release, creating a pumping action to increase local blood circulation.

PACKAGE CONTENTS

The gift box contains the following components:

Standard Parts:

No.	DESCRIPTION	QUANTITY
1	Foot Circulator	1 PC
2	Electrode pad (2" x 2")	4 PCS
3	Lead wires	2 PCS
4	Adaptor	1 PC
5	Remote Control	1 PC
6	Instruction manual	1 PC
7	AAA Batteries	2 PC

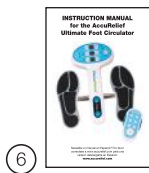
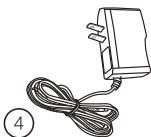
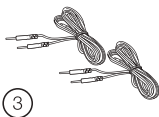
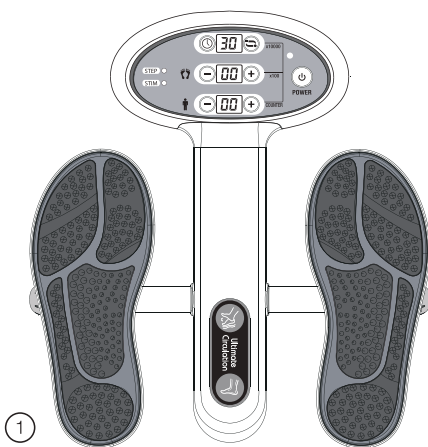

FEATURES

- 1) Three output channel electrical stimulator—(1) channel for foot stimulation, (2) channel for body stimulation
- 2) Power supply—adaptor (included) or 4-C batteries (optional).
- 3) Settings can be controlled on the panel or with the remote control.
- 4) The LED displays: treatment time, intensity of foot stimulation and intensity of body stimulation separately. Or altogether to display your steps when using just the stepper.

Front and Rear Panel

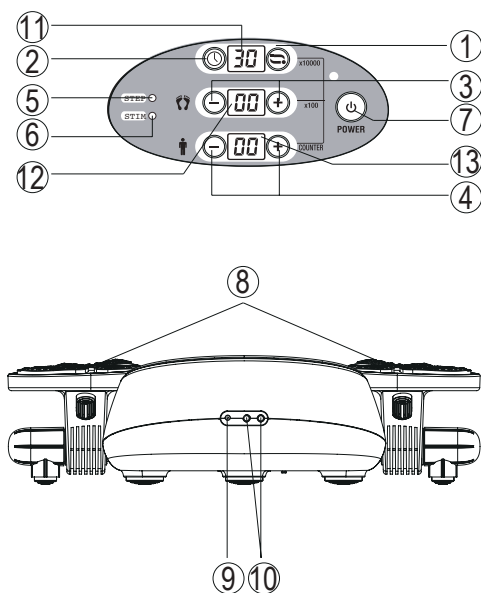

- 1) Mode button : To change from STEP to STIM
- 2) Adjusts the treatment time
- 3) Increases or decreases the intensity of foot stimulation
- 4) Increases or decreases the intensity of body stimulation
- 5) STEP mode LED light
- 6) STIM mode LED light
- 7) Power on/off button
- 8) Foot pads
- 9) Adaptor socket
- 10) Output socket for lead wires (body stimulation)
- 11) Displays treatment time or steps $\times 10000$
- 12) Displays intensity of foot stimulation or steps $\times 100$
- 13) Displays intensity of body stimulation or steps

ADAPTOR

Steps to connect the adaptor

1) Insert the DC plug of the adaptor into the adaptor socket on the device. (Please hold the main unit tightly when inserting the DC plug into the adaptor socket. Insert and pull out the DC plug in correct direction.)

Input: 100V~240VAC, 50/60Hz;

Output: DC6.0V, (300mA)

2) Insert the adaptor into the power supply socket. Make sure the power voltage is appropriate.

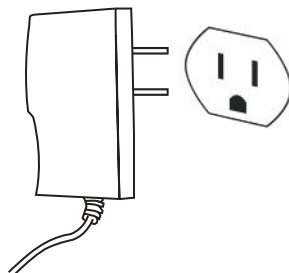
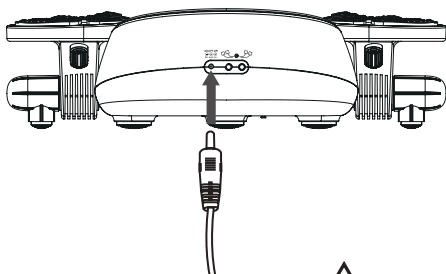

Please use the original adaptor. The user cannot assemble or change the specification of the adaptor. Personal injury or damage to the unit may occur if you do not follow above instructions.

BATTERY

Check/Replace the battery (not included)

Over time, in order to ensure the functional safety of device, changing the batteries are necessary. (Device will work with adaptor only.)

- 1) Open the battery compartment cover.
- 2) Insert four batteries (type C) into the battery compartment (optional).
- 3) Make sure you are installing the batteries properly. Be sure to match the positive and negative ends of the battery to the marking in the batteries compartment of the device.
- 4) Replace the battery compartment cover and secure tightly in place.

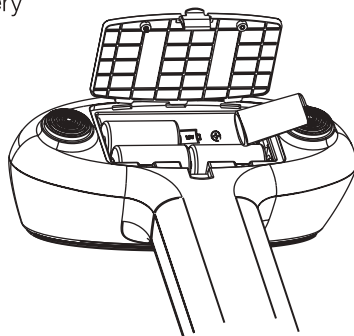

Disposal of batteries

Depleted batteries do not belong in the household waste. Dispose of the batteries according to your federal, state and local regulations. As a consumer, you are obligated by law to return depleted batteries.



CAUTION

- 1) Keep the batteries and the product out of the range of children.
- 2) If the batteries leak, avoid contact with skin, eyes and mucus membranes. Rinse the affected spots with lots of clear water immediately and contact a physician right away if the leak had contact with your skin, eyes or mucus membranes.
- 3) Batteries may not be charged, dismantled, thrown into fire or short-circuited.
- 4) Protect batteries from excess heat. Take the batteries out of the product if they are depleted or if you do not use the device for a long time. This prevents damage caused by leaking batteries.
- 5) Always replace with the same type of batteries.

DIRECTIONS FOR USE

Foot and Leg Stimulation ()

Step 1 - Place the device on the floor.

Place the device on the floor, a comfortable distance from your chair. Sit down on your chair while maintaining 90 degrees at both knees.

WARNING: Never stand on the AccuRelief Ultimate Foot Circulator.

Step 2 - Place both bare feet onto the footpads.

Remove all socks and stockings and place bare feet onto the footpads. The arch of your foot should be positioned on the raised instep on the footpads. It does not matter if your feet are smaller or bigger than the footpads, as long as pressure is on the instep.



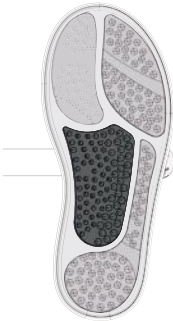

Both the footboards of the AccuRelief Ultimate Foot Circulator can tilt back and forth. This gentle and involuntarily feature creates ankle joint movement for increased circulation.

CAUTION:

- Two feet are required to create the stimulation.
- Sit with your knees both at a 90 degree angle.



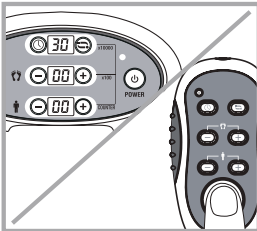

Step 3 - Turn on the device

To turn on the device. Press the power button [] on the device or use the remote control. In the default setting, the display lights will read [] 30 minutes, [] 00 output intensity, [] 00 output intensity.



Step 4- Setting the treatment time

Using either the remote control or buttons on the device, set the treatment time by using the [] button. The treatment time is adjustable between 5, 10, 15, 30, 60 and 90 minutes as a cycle.

Please note: If you want to do combination foot and body stimulation, skip Steps 5 & 6 and go directly to Step 1 of Body Stimulation () on page 14.

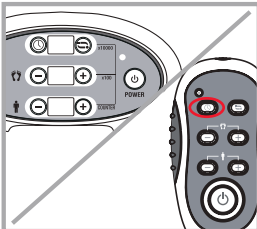

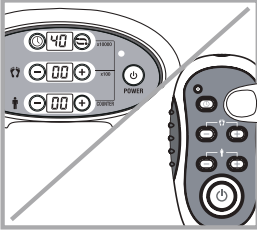



Step 5 - Start treatment and adjust intensity

Using either the remote control or buttons on the device, press the -/+ [] button to set the intensity level. The treatment will begin and the display will start counting down the remaining minutes of treatment.

CAUTION

- We recommend using a conductive medium on your feet to improve conductivity and stimulation. Each person may require a different intensity level to obtain the optimal muscle stimulation. The device can safely be used on intensity level 1 and up to maximum level 99.
- There are 15 therapeutic phases working throughout the cycle time changing every minute. (See page 18 for phase programs)
- When using the AccuRelief Ultimate Foot Circulator, the footboards can tilt back and forth as your muscles contract and relax for increased therapeutic value.
- If you remove your foot from the foot pads, the device will give three short “Beeping” sounds. Intensity will slowly decrease. Once you place your feet back on the foot pads, the intensity level will increase slowly to the level you set. During this period, the display shows the intensity level you set.
- You can press [] to shift the modes between Stepper and Stimulation. **Please note:** Your foot stimulation will still be active when you change between the Stepper and Stimulation LED screen. When the () is lit, the LCD displays your # of steps. When the () is lit, the LCD displays the intensity stimulation. **Note:** There may be times throughout certain phases when you will need to increase or decrease the intensity.

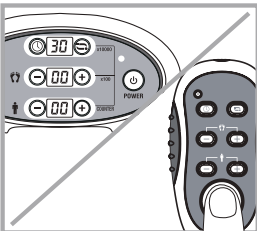

Step 6 - Turn OFF the device

To turn OFF the device. Press the power button [] on the device or the remote control. The display also has an automatic shut-off once the timer reaches zero.

Body Stimulation ()

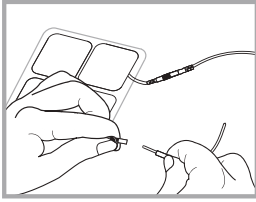

Step 1 - Attach pads to the lead wire

Take the pads out of the sealed package; insert the pin of the lead wires into the pigtail of the electrode pads. Make sure there are no bare metal pins exposed.

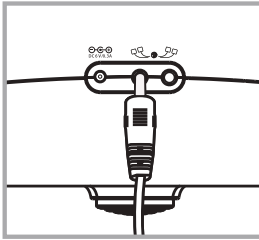

Step 2 - Insert lead wires to the device.

Hold the lead wires plug and insert into the socket on the back of the AccuRelief Ultimate Foot Circulator.



- Ensure that your AccuRelief Ultimate Foot Circulator is turned OFF.
- You can use one or two channels according to your need. If using only one channel (2 pads) it must be plugged into socket labeled #1.
- But you must always use at least two pads for stimulation.

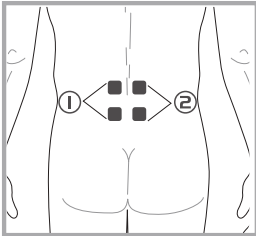

Step 3 - Pad placement

Remove the pads from the clear plastic film. Place pads on clean, dry and healthy skin near or surrounding the specific body part (as pictured). For more pad placement suggestions, refer to page 19-20 of "ACCURELIEF PAD PLACEMENT GUIDE"

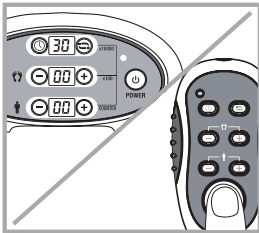

Step 4 - Turn on the device

To turn on the device. Press the power button [] on the device or use the remote control.

In the default setting, the display lights will read [] 15 minutes, [] 00 output intensity, [] 00 output intensity.

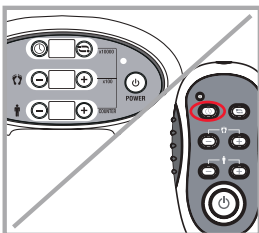



Step 5- Setting the treatment time

Using either the remote control or buttons on the device, set the treatment time by using the [] buttons.

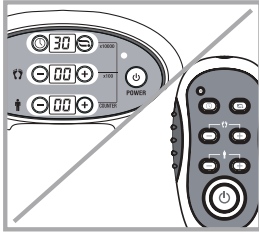
The treatment time is adjustable between 5, 10, 15, 30, 60 and 90 minutes as a cycle.



Step 6 - Start treatment and adjust intensity

Using either the remote control or buttons on the device, press the -/+ [] button to set the intensity level. The treatment will begin and the [] display will start counting down the remaining minutes of treatment.

CAUTION

- Each person may require a different intensity level to obtain the optimal muscle stimulation. The device can safely be used on intensity level 1 to maximum level of 99. If the stimulation levels are uncomfortable or become uncomfortable, reduce the stimulation intensity to a comfortable level and contact your medical practitioner if problems persist.
- For safety purposes, this device was designed with load detection. If the electrode pads are removed from the skin, an alarm buzzer will sound and the intensity value will return to zero automatically.

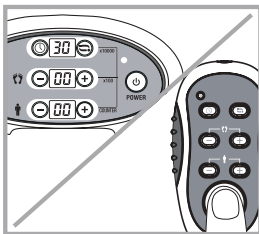



Step 7 - Turn OFF the device



To turn OFF the device. Press the power button [] on the device or the remote control. The display also has an automatic shut-off once the timer reaches zero.

Combination of Foot and Body Stimulation

You can use Foot and Body Stimulation at the same time or individually.

Stepper Function

Tilt your feet back and forth during the treatment. You can press [] to shift the display of modes between Stepper and Stimulation. When the STEP LED is lit (), the LCD displays your # of steps. When the STIM LED is lit (), it displays treatment time and intensity for stimulation.

For exact amount of steps done, the [] LED multiplies your steps by 10,000. The number displayed on [] LED multiplies your steps by 100. The number on [] LED displays steps up to 99. For example, the below LCD display, the steps are “303711” which means your feet tilted back and forth “33,711” times.

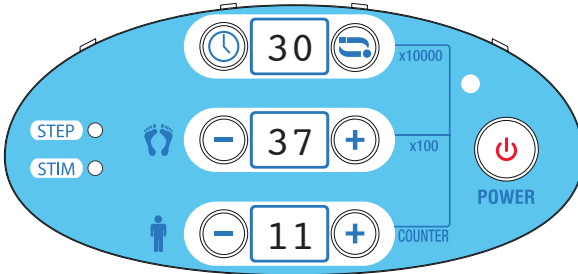

Warning: If you press any other button than [] while in STEP mode, it will affect the stimulation settings (if stimulation is active).

Remote Control

The remote control allows you to sit back and relax without having to bend over to operate the device. It is important to always aim the remote control towards the digital display on the device, as this is where the receiver is located.

CAUTION

1. Remove the batteries if the remote control is not being used for a long period of time.
2. Do not mix old and new batteries or different types of batteries.
3. Warning: If batteries leak and touch your skin or get into your eyes, wash with large amounts of water immediately.
4. Keep batteries out of reach of children.
5. Do not use rechargeable batteries. Remove depleted batteries from the unit.

SPECIFICATION

- Channels: Three, Isolated, (One) for Foot Stimulation, (Two) for Body Stimulation)
- Output Amplitude: 0~80mA (500 Ω Load)
- Waveform type: Symmetrical Biphasic square pulse with zero DC current
- Power Sources: Adaptor (included) or batteries (optional)
Input 100V~240V, 50/60Hz
Output: DC6V, 300mA
Or DC 6.0V, (4) C Batteries (Optional)
- Frequency: 10Hz~36Hz
- Pulse Width: 250us for foot stimulation;
200us for body stimulation
- Treatment Time: 1-99min
- Operating Conditions: 5°C~40°C; 30%RH~75%RH
- Storage Conditions: -10°C~55°C; 10%RH~90%RH
- Size: 427.3mmx417mmx104mm
- Weight: 4.21 lbs (Main device only, without batteries)
- One year warranty
- The essential performance of the device is free from the production of unwanted or excessive stimulation output.

Program

A. Foot stimulation program

	Phase Number	Frequency (Hz)	On time (s)	Off time (s)	Cycle Time (s)
1) Time: 1~99 minutes 2) Frequency: 10Hz~36Hz 3) Pulse width: 250us 4) On time: 1.9s~10.6s 5) Off time: 1.0s~3.7s 6) Cycle Time: 3.5s~11.6s	1	10	3.4	1.0	4.4
	2	12.5	7.2	1.0	8.2
	3	20	6.4	1.0	7.4
	4	36	2.1	2.1	4.2
	5	16.6	4.4	1.5	5.9
	6	10	4.7	1.0	5.7
	7	36	1.9	1.6	3.5
	8	12.5	4.3	1.1	5.4
	9	10	3.7	3.7	7.4
	10	20	9.2	1.0	10.2
	11	31	2.2	1.5	3.7
	12	22	10.6	1.0	11.6
	13	16	5.1	1.0	6.1
	14	20	6.7	1.0	7.7
	15	22	7.6	1.1	8.7

B. Body stimulation program

Program	Description
1) Time: 1~99 minutes 2) Frequency: 20Hz 3) Pulse width: 200us 4) On time: 11s 5) Off time: 5s 6) Duty cycle: 16s	The pulses take 3 seconds from zero to 12 pulses and stays for 5 seconds, and then takes 3 seconds from 12 pulses to zero; then the device stops output for 5 seconds. The device repeats this cycle during the treatment time. The output frequency is 20Hz and the pulse width is 200us.

ELECTRODE PLACEMENT GUIDE

• Stimulation Position:

Position yourself comfortably in the position as shown in the pictures. The muscles work in an isometric fashion and in a stretched position. To work comfortably and safely, keep your limbs in a fixed position (keep your hands or feet to one spot). This provides maximum resistance to movement and stops the muscle from tightening during the contraction.

• Placement of the Electrodes:

A lead wire connects with 2 pads:

a positive pole (+) = red connection

a negative pole (-) = black connection

The positive pads must be placed over the motor point of the muscle (see images). Always follow the placement directions in the images.

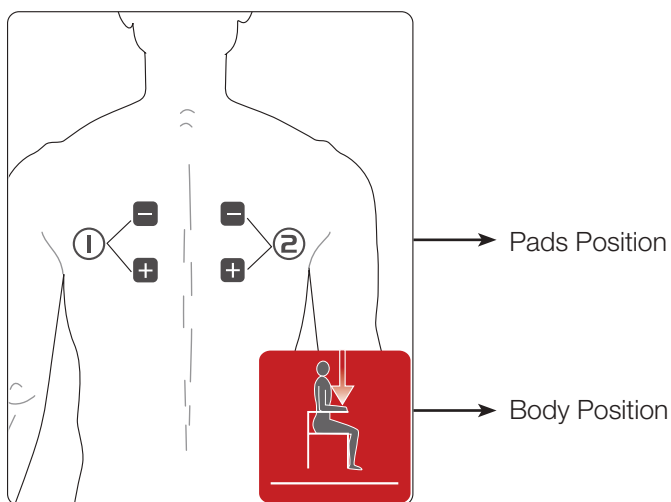

THE ACCURELIEF™ PAD PLACEMENT GUIDE

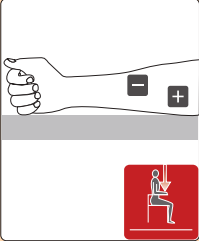
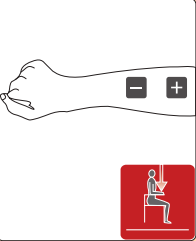
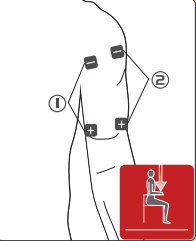
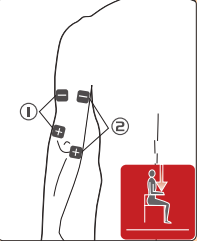
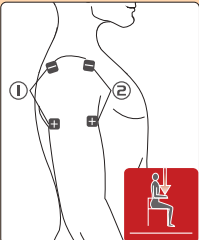
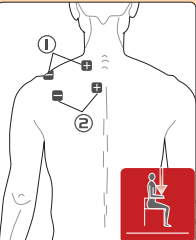
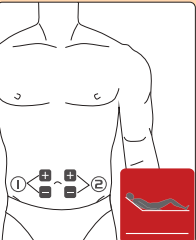
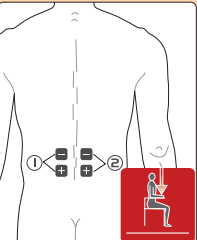
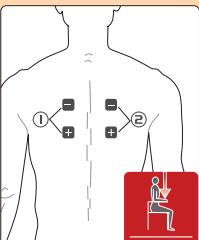
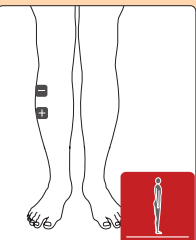
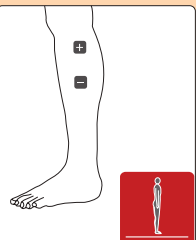
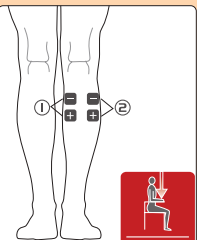
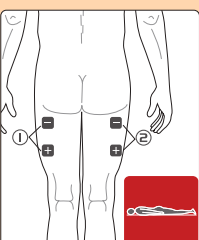
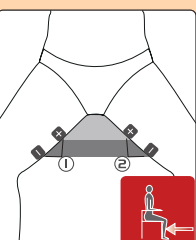
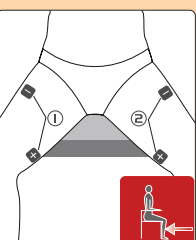
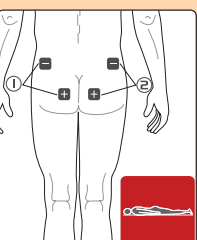
<p>EXTENSORS: Hand</p> 	<p>Flexors: Hand</p> 	<p>Biceps</p> 	<p>Triceps</p> 
<p>Deltoid (Shoulder)</p> 	<p>Trapezius</p> 	<p>Abdominal muscles</p> 	<p>Low back muscles</p> 
<p>Erector spinalis (upper back)</p> 	<p>Tibialis anterior</p> 	<p>Peroneous muscles</p> 	<p>Calf muscles</p> 
<p>Hamstrings (Back of thighs)</p> 	<p>Adductors</p> 	<p>Quadriceps</p> 	<p>Gluteus (Buttocks)</p> 

FAQ'S

How long is the device warranty?

One year.

How many times can the electrodes be used?

Depending on your skin type, between 10-15 times. Fifteen applications may be possible on skin that is clean, non-greasy and free of excess hair. You should replace the pads when they no longer adhere to the skin or when the muscle contractions are noticeably weaker compared to previous usage.

Are there any absolute contraindications when it comes to the electrical stimulation of muscles?

Yes. The device must not be used in the case of epilepsy or on patients who wear a pacemaker. In addition, stimulation must never be applied around the stomach area in women who are pregnant, or for people suffering from a hernia or eventration. You must also never apply the electrodes to the head and avoid the area around the heart.

How do I find the exact motor sensory point?

The photos of the position of the pads (refer to pages 19-20 of this user manual) show the precise recommended location. To locate your own motor sensory point more accurately, you can move the positive pad slightly (red connection) and watch where the muscle response is the best (strongest twitch of the same intensity).

What position should I be in during Muscle Training sessions?

For programs involving powerful muscular contractions (tetanic contractions), the muscle should always be stimulated in an isometric fashion. To do this, avoid moving them as much as possible.

Working in this way ensures completely safe stimulation. This also helps to reduce the shortening of the muscle during the contraction, and consequently, reduces the risk of severe cramping which might otherwise occur.

Is tolerance to the level of electrical intensity the same for everybody?

No. Everyone has their own level of sensitivity, that depends in particular on the constitution (fat, conjunctive tissue, etc.) of their body make-up. You may also experience varied levels of sensitivity throughout each phase change. It is recommended to adjust the intensity levels to be comfortable and therapeutic.

How much intensity level should be set?

Each person may require a different intensity level to obtain the optimal muscle stimulation. You should set the intensity in your comfortable range. At the beginning of the process, you should set a comfortable level, and then reduce or increase the intensity level according to your tolerance throughout the phases of stimulation.

How long should I use the device?

The AccuRelief Ultimate Foot Circulator is intended to stimulate muscles to improve or facilitate muscle performance. The device can be used 2-3 times a day for up to 30-60 minutes.

Who I should contact when I have question about the device?

If you have any questions about operation, please feel free to contact Carex Health Brands at 800-328-2935.

CLEANING AND STORAGE

Cleaning the unit

- 1) Turn unit off and disconnect the lead wires from the unit.
- 2) Clean the device after use with a soft, slightly moistened cloth and wipe gently.
 - Do not use chemicals (like thinner, benzene).
 - Do not let water get into the internal area.

Note:

- This device and accessories (including the pads) do not require sterilization.

Cleaning the electrode pads

- 1) Turn the power off and remove the lead wires from the pads.
- 2) If the pads becomes dirty and/or the pads are difficult to attach, put a drop of water on your finger and spread over entire pad. Do not saturate the pad.

Do not use a sponge/cloth/sharp object like a nail on adhesive side.

Do not use detergents, chemicals or soap.
- 3) Dry the pads by placing them gel side up and let the adhesive surface air-dry completely (do not wipe with a tissue paper or cloth). If your pads are still not sticking or remain dirty, replace with new pads.



CAUTION:

- 1) The life of pads may vary by the frequency of washing, skin condition, and storage state.
- 2) If the pad no longer sticks to your skin or the pad is broken, you should replace with new pads.
- 3) Before applying the self-adhesive pads, it is recommended to wash and degrease the skin, and let your skin dry completely.
- 4) Do not turn on the body stimulation when the pads are not positioned on the body.
- 5) Never remove the self-adhesive electrodes from the skin while the device is still turned on.
- 6) If replacement pads are necessary, use only pads that are the same size (2" x 2") as the pads provided with the device.
- 7) Use of pads that are larger may reduce the effect of the stimulation. Use of pads that are much smaller than the pads provided with the device may increase the chance of skin irritation or electrode burns occurring under the pads.
- 8) Always use pads that have been cleared for marketing in the US by the FDA.

Storing the electrode pads and lead wires

- 1) Turn the device off and remove the lead wires from the unit.
- 2) Remove the pad from your body and pull out lead wires from the pads.
- 3) Place the pads onto the plastic film and then store into the sealed package.
- 4) Fold the lead wires as they were originally packaged, secure with twist tie and store in the sealed bag.

Storing the unit

- Place the unit, pads, lead wires and manual back into gift box. Store the box in a cool, dry place, $-10^{\circ}\text{C}\sim 55^{\circ}\text{C}$; 10% ~90% relative humidity.
- Do not keep in places that can be easily reached by children
- When not in use for a long period, remove the batteries before storage, to avoid liquid discharge from batteries.

TROUBLESHOOTING

Problem	Possible Causes	Possible Solution
The unit cannot power on.	Are the batteries depleted?	Replace the batteries.
	Are the batteries installed correctly?	Insert the batteries observing polarity.
	Is the adaptor connected to the device and main socket correctly?	Reconnect the adaptor to the device and main socket according to “Steps to connect the adaptor” in this manual.
Stimulation weak or cannot feel any stimulation.	Pads dried out or contaminated.	Replace with new pads.
	Pads cannot stick to skin	Reconnect the pads or replace with new pads.
	Lead wires old/worn/damaged	Replace new lead wires.
	Is the intensity too weak?	Use a higher intensity level.
	Both feet are not properly placed on foot pads as indicated on Page 12, Step 2 of the manual	Please refer to Page 12, Step 2 for proper foot placement.
Device is on, but feet cannot feel the electrical stimulation.	Feet may be dry.	Moisturize the soles of your feet preferably with a conductive medium and try the procedure again. You may also have to increase the intensity level.
While putting your foot back on the foot pads or connecting the pads back to the body, the intensity does not slowly turn back to the preset level.	You may not be placing both bare feet on the foot pads at the same time.	Ensure that your feet are bare and each foot is placed on each of the foot pads at the same time. Keep increasing the intensity up to a maximum of 80 until you can feel the stimulation.
	You may be dehydrated.	Drink plenty of water before and after using the device. The device uses your body to create the electrical circuit. Water is an excellent conductor of electricity and if your body is less hydrated (below 60%) then the stimulation may be less. Therefore it is important to always remain well hydrated.
My legs are aching after treatment.	You may have the intensity on too high a setting and your muscles are being overworked.	Choose a lower intensity and leave adequate time after each treatment to allow the muscles to recover (just like after vigorous exercise!).

Problem	Possible Causes	Possible Solution
Stimulation is uncomfortable	Intensity is too high.	Decrease intensity.
	Pads are too close.	Reposition the pads at least 1 ½" apart.
	Pad active area size is too small.	Replace pads with an active area no less than 2" x 2".
	May not be operating the device according to the manual.	Please check the manual before use.
Intermittent output	Lead wires.	Verify connection is secure with no bare metal pins showing.
		Turn down the intensity. Rotate lead wires in socket 90°. If still intermittent, replace lead wires.
		If still intermittent after replacing lead wire, a component may have failed. Call the tech support department.
Stimulation is ineffective.	Improper pads placement.	Reposition pads.
	Unknown.	Contact clinician.
The skin becomes red and/or you feel a stabbing pain	Using the pads on the same site every time.	Re-position the pads. If at any time you feel pain or discomfort stop using immediately.
	The pads aren't stuck onto the skin properly	Ensure the pads are stuck securely on the skin. If not, replace with new pads.
	The pads are dirty.	Clean the pads according to description in this manual (pg. 23) or replace with new pads.
	The surface of the pads was scratched.	Replace with new pad.
Output current stops during therapy	The pads come off the skin.	Turn off the device and place the pads again.
	The lead wires are disconnected.	Turn off the device and connect the lead wires.
	The power of the batteries is depleted.	Replace w/ new batteries.
	Is the adaptor properly connected with unit?	Firmly connect the adaptor to the unit.
	Device is cycling through a new phase.	Increase intensity during this phase or wait 1 minute for next phase to start (see pg 18 for phase programs).

DISPOSAL

Used fully discharged batteries must be disposed of in a specially labeled collection container, at toxic waste collection points or through an electrical retailer. You are under legal obligation to dispose of batteries correctly.



Please dispose of the device in accordance with the legal obligation.

GLOSSARY OF SYMBOLS



Electrical devices are recyclable material and should not be disposed of with household waste after their useful life! Help us to protect the environment and save resources and take this device to the appropriate collection points. Please contact the organization which is responsible for waste disposal in your area if you have any questions.



Type BF Applied Part



Please refer to instruction manual because of the higher levels of output.



Keep dry

WARRANTY

Please contact Carex Health Brands at 800-328-2935 in case of a claim under the warranty. If you have to send in the unit, enclose a copy of your receipt and state what the defect is. The following warranty terms apply:

- 1) The warranty period for device is one year from date of purchase. In case of a warranty claim, the date of purchase has to be proven by means of the sales receipt or invoice.
- 2) Repairs under warranty do not extend the warranty period either for the device or for the replacement parts.
- 3) The following is excluded under the warranty:
 - All damages due to improper treatment, e.g. nonobservance of the user instruction.
 - All damages due to repairs or tampering by the customer or unauthorized third parties.
 - Damage during transport from the manufacturer to the consumer or during transport to the service center.
 - Accessories which are subject to normal wear and tear.
- 4) Liability for direct or indirect consequential losses caused by the unit are excluded even if the damage to the unit is accepted as a warranty claim.

IMPORTANT INFORMATION REGARDING ELECTRO MAGNETIC COMPATIBILITY (EMC)

This product needs special precautions regarding EMC and needs to be installed and put into service according to the EMC information provided, and this unit can be affected by portable and mobile RF communications equipment.

- 1) *Do not use a mobile phone or other devices that emit electromagnetic fields, near the unit. This may result in incorrect operation of the unit.
- 2) Caution: This unit has been thoroughly tested and inspected to assure proper performance and operation!
- 3) *Caution: this machine should not be used adjacent to or stacked with other equipment and that if adjacent or stacked use is necessary, this machine should be observed to verify normal operation in the configuration in which it will be used.
- 4) Warning:

The use of ACCESSORIES, transducers and cables other than those specified, with the exception of transducers and cables sold by the MANUFACTURER of the ELECTRICAL STIMULATOR as replacement parts for internal components, may result in increased EMISSIONS or decreased IMMUNITY of the ME EQUIPMENT or ME SYSTEM.

Guidance and manufacture's declaration – electromagnetic emission

The ELECTRICAL STIMULATOR is intended for use in the electromagnetic environment specified below. The customer or the user of the ELECTRICAL STIMULATOR should assure that it is used in such an environment.

Emission test	Compliance	Electromagnetic environment – guidance
RF emissions CISPR 11	Group 1	The ELECTRICAL STIMULATOR uses RF energy only for its internal function. Therefore, its RF emissions are very low and are not likely to cause any interference in nearby electronic equipment.
RF emissions CISPR 11	Class B	The ELECTRICAL STIMULATOR is suitable for use in all establishments, including domestic establishments and those directly connected to the public low-voltage power supply network that supplies buildings used for domestic purposes.
Harmonic emissions IEC 61000-3-2	Class A	
Voltage fluctuations/ flicker emissions IEC 61000-3-3	Complies	

Guidance and manufacture's declaration – electromagnetic immunity

The ELECTRICAL STIMULATOR is intended for use in the electromagnetic environment specified below. The customer or the user of ELECTRICAL STIMULATOR should assure that it is used in such an environment.

Immunity test	IEC 60601 test level	Compliance Level	Electromagnetic environment – guidance
Electrostatic discharge (ESD) IEC 61000-4-2	±6 kV contact ±8 kV air	±6 kV contact ±8 kV air	Floors should be wood, concrete or ceramic tile. If floors are covered with synthetic material, the relative humidity should be at least 30%.
Electrical fast transient/burst IEC 61000-4-4	±2 kV for power supply lines	±2 kV for power supply lines	Mains power quality should be that of a typical commercial or hospital environment.
Surge IEC 61000-4-5	± 1 kV line(s) to line(s)	Class A	Mains power quality should be that of a typical commercial or hospital environment.
Voltage dips, short interruptions and voltage variations on power supply input lines IEC 61000-4-11	<5% UT (>95% dip in UT) for 0.5 cycle 40% UT (60% dip in UT) for 5 cycles 70% UT (30% dip in UT) for 25 cycles <5% UT (>95% dip in UT) for 5 sec	<5% UT (>95% dip in UT) for 0.5 cycle 40% UT (60% dip in UT) for 5 cycles 70% UT (30% dip in UT) for 25 cycles <5% UT (>95% dip in UT) for 5 sec	Mains power quality should be that of a typical commercial or hospital environment. If the user of the ELECTRICAL STIMULATOR requires continued operation during power mains interruptions, it is recommended that the ELECTRICAL STIMULATOR be powered from an uninterruptible power supply or a battery.
Power frequency (50Hz/60Hz) magnetic field IEC 61000-4-8	3A/m	3A/m	Power frequency magnetic fields should be at levels characteristic of a typical location in a typical commercial or hospital environment.

NOTE UT is the a.c. mains voltage prior to application of the test level.

Guidance and manufacture's declaration – electromagnetic immunity

The ELECTRICAL STIMULATOR is intended for use in the electromagnetic environment specified below. The customer or the user of ELECTRICAL STIMULATOR should assure that it is used in such an environment.

Immunity test	IEC 60601 test level	Compliance Level	Electromagnetic environment – guidance
<p>Conducted RF IEC 61000-4-6</p> <p>Radiated RF IEC 61000-4-3</p>	<p>3 Vrms 150 kHz to 80 MHz</p> <p>3 V/m 80 MHz to 2.5 GHz</p>	<p>3 Vrms</p> <p>3 V/m</p>	<p>Portable and mobile RF communications equipment should be used no closer to any part of the ELECTRICAL STIMULATOR, including cables, than the recommended separation distance calculated from the equation applicable to the frequency of the transmitter.</p> <p>Recommended separation distance</p> $d = 1.167\sqrt{P}$ <p>80 MHz to 800 MHz</p> $d = 1.167\sqrt{P}$ <p>800 MHz to 2.5</p> $d = 2.333\sqrt{P}$ <p>Where P is the maximum output power rating of the transmitter in watts (W) according to the transmitter manufacturer and d is the recommended separation distance in metres (m).</p> <p>Field strengths from fixed RF transmitters, as determined by an electromagnetic site survey,^a should be less than the compliance level in each frequency range.^b</p> <p>Interference may occur in the vicinity of equipment marked with the following symbol:</p> 

NOTE 1 At 80 MHz and 800 MHz, the higher frequency range applies.

NOTE 2 These guidelines may not apply in all situations. Electromagnetic propagation is affected by absorption and reflection from structures, objects and people.

a Field strengths from fixed transmitters, such as base stations for radio (cellular/cordless) telephones and land mobile radios, amateur radio, AM and FM radio broadcast and TV broadcast cannot be predicted theoretically with accuracy. To assess the electromagnetic environment due to fixed RF transmitters, an electromagnetic site survey should be considered. If the measured field strength in the location in which the ELECTRICAL STIMULATOR is used exceeds the applicable RF compliance level above, the ELECTRICAL STIMULATOR should be observed to verify normal operation. If abnormal performance is observed, additional measures may be necessary, such as reorienting or relocating the ELECTRICAL STIMULATOR.

b Over the frequency range 150 kHz to 80 MHz, field strengths should be less than 3 V/m.

Recommended separation distances between portable and mobile RF communications equipment and the ELECTRICAL STIMULATOR.

The ELECTRICAL STIMULATOR is intended for use in an electromagnetic environment in which radiated RF disturbances are controlled. The customer or the user of the ELECTRICAL STIMULATOR can help prevent electromagnetic interference by maintaining a minimum distance between portable and mobile RF communications equipment (transmitters) and the ELECTRICAL STIMULATOR as recommended below, according to the maximum output power of the communications equipment.

Rated maximum output power of transmitter (W)	Separation distance according to frequency of transmitter (m)		
	150 KHz to 80 MHz $d = 1.167\sqrt{P}$	80 MHz to 800 MHz $d = 1.167\sqrt{P}$	800 MHz to 2.5 GHz $d = 2.333\sqrt{P}$
0.01	0.117	0.117	0.233
0.1	0.369	0.369	0.738
1	1.167	1.167	2.333
10	3.689	3.689	7.379
100	11.667	11.667	23.333

For transmitters rated at a maximum output power not listed above, the recommended separation distance d in metres (m) can be estimated using the equation applicable to the frequency of the transmitter, where P is the maximum output power rating of the transmitter in watts (W) according to the transmitter manufacturer.

NOTE 1 At 80 MHz and 800 MHz, the separation distance for the higher frequency range applies.

NOTE 2 These guidelines may not apply in all situations. Electromagnetic propagation is affected by absorption and reflection from structures, objects and people.