

*Escape*  
**mini**™

by Triumph Mobility

# User Manual



**500-20203 :**  
**20" Seat height**

**500-20233 :**  
**23" Seat height**



- **Read Instructions carefully before use.**
- **Do NOT use as a wheelchair or as a transport chair.**
- **Instruction manual must be given to the user.**

# 1. For Your Safety

- a) Do NOT use the walker to carry heavy objects.
- b) Do NOT push the walker when someone is sitting on the seat.
- c) Walker must be fully unfolded when being used as a walking aid.
- d) Always check the brakes are working before using.
- e) Do NOT sit on walker and push yourself around using your feet to propel.
- f) Do NOT stand on the seat.
- g) Parking brake must be applied before sitting.
- h) Do NOT use on stairs or escalators.
- i) Exercise caution when walking on sloped surfaces.
- j) Do NOT hang objects from the backstrap.
- k) Do NOT use if the walker is not functioning properly.
- l) The weight capacity of the walker is 275lb / 125kg.
- m) The weight capacity of the shopping bag is 11lb / 5kg.
- n) When storing your walker, do not store other items on top of your walker.

# 2. Assembly

## \* Phillips screwdriver required

The Triumph Mobility Escape Mini walker consists of the following parts.

- (a) Walker frame with brake.
- (b) Backstrap & 2 screws and nuts.

Check each part carefully for shipping damage. Do not use the walker if there are signs of damage and/or parts missing.

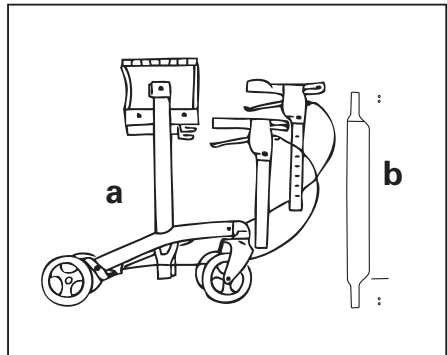

## Install the brake handles

Walker should be in the unfolded position before beginning. While holding the 'RED' release lever in the open position, slide the brake handle into the frame. Rectangular slots on the brake handle tube should be facing inwards.

Set the desired handle height, and close the 'RED' release lever. The release lever should 'click' when locked into the closed position.

**Note:** If brake handles are inserted with the rectangular slots facing outwards, you will be unable to set the handle height, as the 'RED' release lever will not close, and the brake will not function.

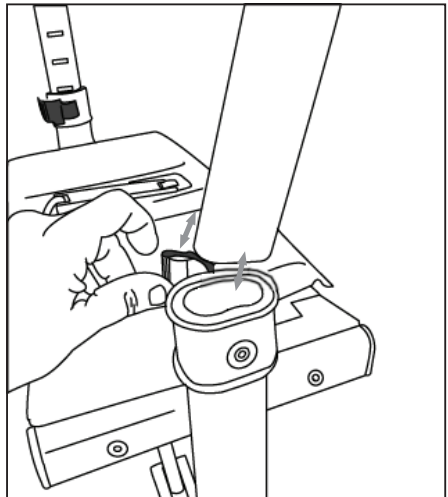

## Install the backstrap

Slide backstrap into the backrest connector. The padded side of the backstrap should face the inside of the walker where it will meet the user's back while seated.

Secure the backstrap into position by inserting the screw and nut. The nut should be positioned into the hexagonal hole on the inside of the backrest connector.

Tighten securely using a Phillips screwdriver.

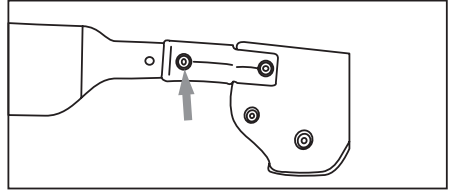
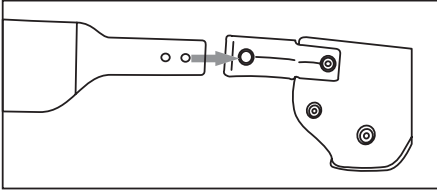

## Install the Shopping Bag

Fix the shopping bag into the brackets located under the seat at the front.

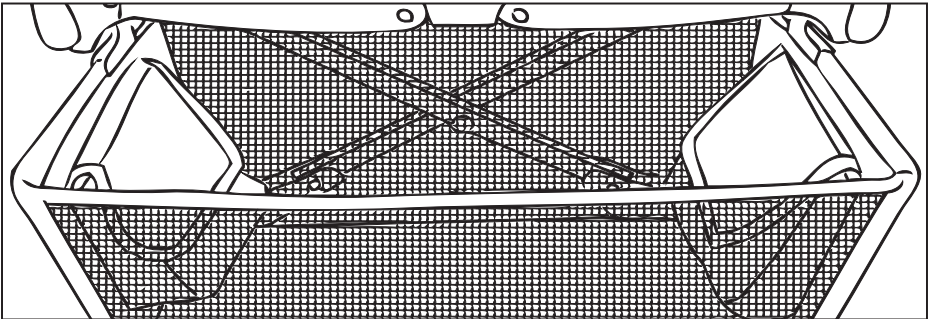

Loop the strap (velcro) around the frame and insert into wire tab.

Firmly secure the velcro strap.

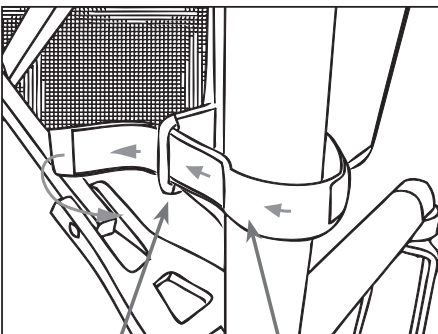

Wire Tab

Strap (Velcro)

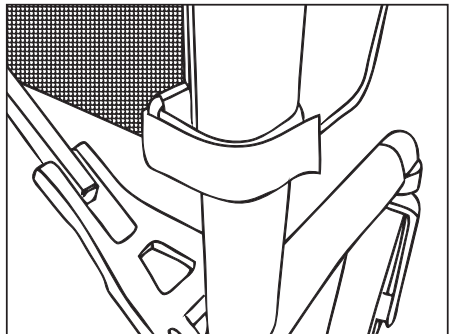

### 3. Operating Your Walker

#### To unfold the Escape Mini

To unfold walker. Pull handles apart, and push down on the seat to lock into place.

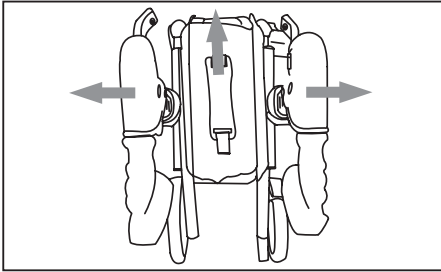

#### To fold the Escape Mini

To fold walker pull up on the handle strap located in the centre of the seat.

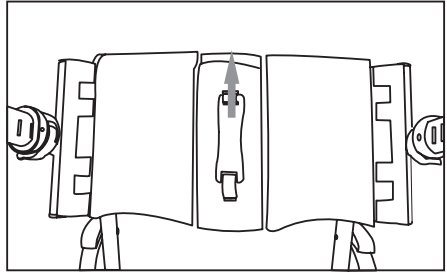

#### Adjust the Handle height

Pull the 'RED' release lever in the open position. Set the desired handle height, and close the 'RED' release lever. The release lever should 'click' when locked into the closed position.

**The bottom edge of the rectangular slot will line up with the top edge of the frame.**

To determine the correct handle height of your walker. Stand straight up with your hands on the handgrips, your arms should be slightly bent 20 - 30 degrees at your elbows.

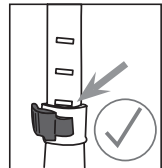
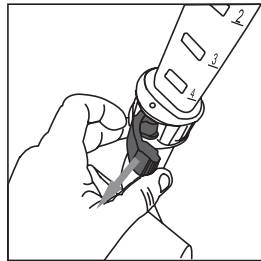

#### Using the Brakes

Pull up on brake handle to slow down or to release the parking brake.

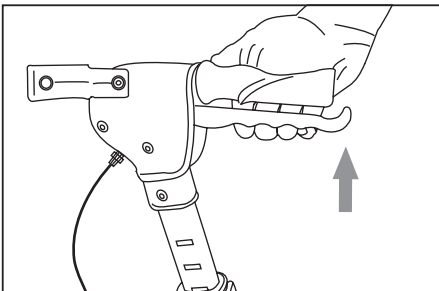

Push down on brake handle to lock the brake into PARK.

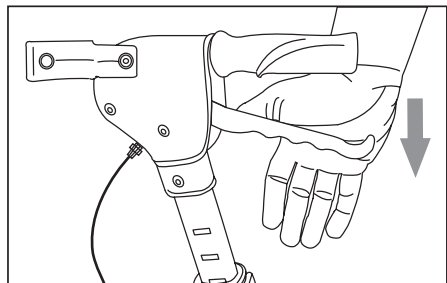

**Always lock the brake before sitting.**

## To adjust the brake tension

If the hand brake is too loose, loosen the locking nut, and turn the adjustment screw counter clockwise.

If the hand brake is too tight, loosen the locking nut, and turn the adjustment screw clockwise.

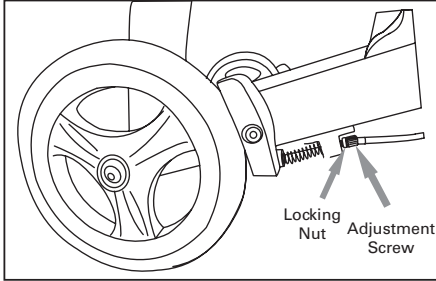

## Walking with the walker

Stand up as straight as possible, and walk with the walker close to your body. Keep your feet centred. Do not push the walker away from your body, as this will cause you to bend your back, and could cause a fall.

## To sit on the Walker

To sit on the walker, ensure that the brakes are in the LOCKED position, and the walker cannot move. Using the handles for stability carefully turn around. Gently touch the back of your legs on the edge of the seat, and sit down. Ensure both feet make contact with the ground while seated.

**DO NOT STOP ON SLOPED SURFACES!**

## Storage

Do not leave your walker subject to the elements outside for extended periods.

When storing the walker, do not store other objects on the walker

## 4. Maintenance

- Clean the walker using mild soap and water. Wipe dry.
- Keep wheels clean.
- Check screws and handle height adjustments are tight.
- If your walker is not working properly, discontinue use, and contact your dealer for service.

## 5. Warranty

Triumph Mobility covers the Escape Mini by a lifetime warranty on the frame, and a five (5) year warranty on the brake handles against defects in materials and workmanship. All other components are warranted for two (2) years.

This warranty is valid for the original purchaser only, and is not transferrable. Triumph Mobility will not warranty any parts that have been damaged due to improper installation, modification, and /or misuse. For warranty service, please return your walker to your local dealer. Service charges are at the discretion of the dealer, and are not the responsibility of Triumph Mobility.

## 6. Warranty Registration

Please register your Escape rollator

When registering, please include the serial number. The serial number can be located on the right side of the frame underneath the seat.

## 7. Walker Specifications

<b>Dimensions</b>	<b>Low</b>	<b>Standard</b>
Seat Height	20" 51cm	23" 58.5cm
Handle Height Range	28.5 - 36.5" 72 - 92cm	31.5 - 39.5" 80 - 100cm
Distance between handles	18" 45.7cm	18" 45.7cm
Distance between wheels	19" 48.25cm	19" 48.25cm
Seat Size	18.5 x 9.5" 47 x 24cm	18.5 x 9.5" 47 x 24cm
Overall Width	25" 63.5cm	25" 63.5cm
Overall Length	25.6" 65cm	25.6" 65cm
Depth Folded	11" 28cm	11" 28cm
Wheel diameter	6" 150mm	6" 150mm
Weight Capacity of walker	275lb 125kg	275lb 125kg
Weight capacity of basket	11lb 5kg	11lb 5kg
Product weight	15.6lb 6.8kg	15.8lb 6.9kg

