

GOLDEN  
**LiteRider<sup>®</sup>ptc**



**Owner's Manual  
Rear Wheel Drive Power Chair  
Model GP162**

 **GOLDEN**  
technologies  
YOUR LIFE IN MOTION

---

Thank you for purchasing your *LiteRider PTC* (Personal Transport Chair). We are honored you have chosen Golden Technologies for your mobility needs.

*LiteRider PTC* Model GP162

Standard Packing List:

1 Owner's Manual  
Base with Under-the-Seat Basket  
1 Battery Pack  
1 Seat  
2 Seat Arms  
1 Joystick Control  
1 Battery Charger  
Seat Post Nut and Bolt

**FOR YOUR RECORDS**

Please fill in your *LiteRider PTC* information below. This information will be useful in the event that you ever need to contact Golden Technologies, Inc. concerning your power chair.

**Your *LiteRider PTC***

Model \_\_\_\_\_ Serial Number \_\_\_\_\_  
Date of Purchase \_\_\_\_\_ Body Color \_\_\_\_\_  
Options \_\_\_\_\_

**Your Golden representative or dealer**

Name \_\_\_\_\_  
Company \_\_\_\_\_  
Address \_\_\_\_\_

**Please remember to fill in and return your warranty registration card.**

**Tools Required:**

The following tools will allow you to make all comfort adjustments to your power chair.

- Socket/Wrenches - 17mm, 14mm, 10mm, and 8mm.
- Allen Wrenches - 8mm, 5mm, and 4mm.

DISCLAIMER

We ask that you read this manual completely before operating your new *LiteRider PTC*. Golden Technologies, Inc. is not and cannot be held responsible for any damage or injury incurred due to improper or unsafe use of the *Golden LiteRider PTC*. Golden Technologies, Inc. specifically disclaims responsibility for any bodily injury or property damage that may occur during any use that does not comply with applicable federal, state, or local laws or ordinances.

# CONTENTS

---

I. Introduction.....	4-5
II. Safety.....	6-9
III. EMI/RFI.....	10
IV. Assembly of your GP162.....	11-15
V. Disassembly and Battery Replacement.....	16
VI. Comfort Settings.....	17-20
VII. Operation/Diagnostics/Troubleshooting.....	21-28
VIII. Battery Charging.....	29-30
IX. Care and Maintenance of your GP162.....	31
X. Riding Your <i>LiteRider PTC</i> .....	32-33
XI. Technical Specifications GP162.....	34-35
XII. Warranty.....	36-37
Warranty/Registration Card.....	38

# I. INTRODUCTION

---

Congratulations on the purchase of your new *LiteRider PTC* (Personal Transport Chair). The *LiteRider PTC*, combines cutting edge technology with attractive designs that are also highly functional in today's world. We at Golden Technologies, Inc. know that you have chosen a power chair that will give you years of dependable operation and also will enhance the quality of your life by providing you with the mobility to experience an active daily lifestyle.

Even though your new *LiteRider PTC* is both user-friendly and designed for maximum maneuverability in even the tightest spaces, we ask that you please read, understand and follow all of the instructions and suggestions in this manual before you operate your power chair for the first time. The safe use of your new power chair is very important to us.

Golden Technologies, Inc. cannot be held responsible for personal injury or property damage resulting from the unsafe or the improper use of any of our broad range of health and personal mobility products. Also, Golden Technologies, Inc. cannot be held responsible for personal injury or property damage resulting from attempts to follow instructions, suggestions, and guidelines presented in this owner's manual.

Our Research and Development Department, our Quality Control Department, and our Engineering Department have used the latest product specifications and the latest product design information to manufacture your *LiteRider PTC*. Golden Technologies, Inc. reserves the right to implement changes into our product lines when those changes become desirable or necessary. If changes are implemented into our product line, there may be minor differences between the product you purchased and the illustrations and instructions in this owner's manual.

# I. INTRODUCTION

## ACCESSORIES for the *LiteRider PTC: (Personal Transport Chair)*

A variety of accessories are available for your Golden *LiteRider PTC*. Please contact your Authorized Golden Technologies Dealer for more information or to order.

- Cane Holder Tube
- Oxygen Tank Holder
- Cup Holder
- Quad Cane Holder
- Walker Holder
- Crutch Holder
- Safety Flag
- Power Chair Cover
- Touch-up Paint
- Deluxe Pack N' Go
- Seat Belt (Optional)

\*Some accessories require a mounting bracket or mounting clips. Please check with your dealer to find out if the accessory you would like to order requires a mounting bracket or mounting clips.

### Safety Guidelines

The symbols below are used in the owner's manual and/or on the product to identify warnings and to notify you of important safety information. Make sure you read and understand them completely.



**WARNING!** Indicate(s) a hazardous situation which, if not avoided, could result in death or serious injury. This icon is represented as a black symbol on a yellow triangle with a black border.



**MANDATORY!** Failure to perform mandatory actions can cause personal injury and/or equipment damage. This icon is represented as a white symbol on a blue dot with a white border.



**PROHIBITED!** Indicate(s) an action(s) that should not be performed under any circumstance. Failure to adhere can cause personal injury and/or equipment damage. This icon is represented as a black symbol with a red circle and red slash.

### Safety Symbols

The symbols below identify warnings, mandatory actions, and prohibited actions. They can be found in the owner's manual and/or on the product. Make sure you understand all safety labels before operating the product. Do not remove safety labels from the product.



Read and follow the owner's manual!



Explosive conditions exist!



Indoor use only!



Use only AGM or Gel-Cell batteries!



Avoid transmitters!



Hot surface!



Pinch/Crush Hazard!



Do not place into trash!



Electrical hazard!



Corrosive chemicals inside battery!



Recycle



Do not use personal electronic devices!

## II. SAFETY

---

Your Golden *LiteRider PTC* is a battery-operated personal mobility vehicle. Please exercise caution and consideration when you are operating it. Driving your *LiteRider PTC* carefully and thoughtfully will help ensure your personal safety and the safety of other people.



**MANDATORY! Read and follow the owner's manual before operating your power chair.**

Note: Before learning to operate your *LiteRider PTC*, have your Golden Technologies, Inc. representative determine if it is advisable for you to practice getting on and off your power chair and operating it in the presence of an attendant.

### **BEFORE getting on your *LiteRider PTC***

- Check to be certain that the power is turned OFF. See “Operation” section on pages 21-28. This will eliminate the possibility of accidentally activating the joystick and causing injury to you or to others.
- Check to be certain that your *LiteRider PTC* is not in the freewheel mode. See the “Operation” section of pages 21-28.
- Flip up the armrests.
- Flip up the footrest.

### **Getting ON your *LiteRider PTC***

- Carefully seat yourself comfortably and securely on the seat.
- Flip down the footrest.
- Flip down the armrests.
- Fasten the seat belt if your chair is equipped with one.

### **Getting OFF your *LiteRider PTC***

- Make certain that the power is turned off.
- Unfasten the seat belt if your chair is equipped with one.
- Flip up the armrests.
- Flip up the footrest.
- Carefully stand and step away from the chair.

### **MAXIMUM WEIGHT**

Your *LiteRider PTC* has been rated to a maximum payload (passenger and anything else being carried on the power chair) of **300 pounds**. Exceeding the maximum weight rating will void your warranty.



**WARNING Exceeding the maximum weight capacity will void your warranty and may result in injury to yourself and/or others.**

## II. SAFETY

---

### DRIVING ON AN INCLINE

- Drive with **caution** when attempting to negotiate any incline, even handicap access ramps.
- Try to keep your *LiteRider PTC* **moving** when climbing an incline. If you do come to a stop, restart and accelerate slowly and carefully.



#### WARNING

- **Always** climb or descend a gradient by driving straight up or straight down the face of the slope.
- **Do not** traverse or drive across the face of a gradient.
- **Do not** attempt to negotiate an incline that is covered with snow, ice, cut or wet grass, leaves, or any other potentially hazardous material.
- **Do not** back down an incline
- **Do not** try to descend or climb a slope whose gradient is greater than the recommended maximum incline of **6 degrees**.



#### WARNING

**IF, WHILE YOU ARE DRIVING DOWN A SLOPE, YOUR POWER CHAIR STARTS TO MOVE FASTER THAN YOU FEEL IS SAFE, RELEASE THE JOYSTICK LEVER AND ALLOW YOUR LITERIDER PTC TO COME TO A STOP. WHEN YOU FEEL THAT YOU AGAIN HAVE CONTROL OF YOUR POWER CHAIR, PUSH THE JOYSTICK LEVER FORWARD AND CONTINUE SAFELY DOWN THE REMAINDER OF THE SLOPE.**

### MEDICATION

Always check with your physician to determine if any of the medications you are taking may affect your judgment and/or your ability to operate your *LiteRider PTC*. Also check with your physician concerning your physical ability to operate a power chair.

## II. SAFETY

---

### SAFETY RULES



#### WARNING

- **Do not** attempt to use your *LiteRider PTC* on an escalator. Always use an elevator.
- **Do not** carry passengers on your power chair.
- **Do not** operate your *LiteRider PTC*, if it is not functioning properly.
- Use **caution** when driving on soft or uneven surfaces such as grass, gravel and on decks where there is no railing.
- **Never** drive on the roadway, except when you must cross the street.
- **Always** cross streets at intersections and use the most direct route, making sure that your path is clear and that you are visible to motor traffic.
- It is **not recommended** to drive your *LiteRider PTC*, up or down a step or curb that is higher than 1-1/2 inches.
- **Never** back up or down a step or curb.
- **Never** operate your *LiteRider PTC*, while you are under the influence of alcohol.
- **Do not** operate or store your power chair where it will be exposed to rain, snow, mist and below-freezing temperatures.
- **Do not** operate your power chair on slippery, icy or salted surfaces.
- **Never** sit on your power chair when it is in freewheel mode and on an incline or decline.
- **Do not** modify your power chair in any way that is not authorized by Golden Technologies, Inc.
- **Do not** disassemble the tire. If disassembly is required, have your authorized Golden Technologies dealer perform any necessary maintenance or repair.
- **Do not** attempt to inflate the tires of your *LiteRider PTC*. Your power chair is equipped with foam-filled flat free tires that do not require inflation.
- **Never** sit on your *LiteRider PTC* when it is being transported.
- **Always** fasten down your *LiteRider PTC* securely with an approved tie-down system while transporting your power chair.



## II. SAFETY

---

Please be sure to follow this important warning when transferring onto or off the Golden *LiteRider PTC*: (Personal Transport Chair)



**WARNING NEVER TRANSFER ON OR OFF OF THIS POWER WHEELCHAIR USING THE SEAT BACKREST FOR SUPPORT DURING TRANSFER. THE SEAT BACK MAY FOLD DOWN AND MAY CAUSE YOU TO LOSE YOUR BALANCE AND COULD RESULT IN PERSONAL INJURY.**

Do not modify your power chair in any way that is not authorized by Golden Technologies, Inc.



**WARNING DO NOT CONNECT OR ALLOW ANYONE EXCEPT AN AUTHORIZED GOLDEN TECHNOLOGIES REPRESENTATIVE TO CONNECT ANY ELECTRICAL OR MECHANICAL DEVICE TO YOUR LITERIDER PTC. UNAUTHORIZED ACCESSORIES WILL VOID THE WARRANTY AND MAY CAUSE INJURY.**

### III. EMI/RFI

---

The rapid development of electronics, especially in the area of communications, has saturated our environment with electromagnetic (radio) waves that are emitted by television transmitters, cellular phones, citizen's band radios (CBs) amateur radios (HAM radios), wireless computer links, microwave transmitters, paging transmitters, etc. These electromagnetic (EM) waves are invisible and increase in strength the closer one gets to the source of transmission. When these energy waves act upon electrical devices and cause them to malfunction or to function in an erratic or uncontrolled manner, they are referred to as Electromagnetic Interference (EMI) or Radio Frequency Interference (RFI).

#### EMI/RFI AND YOUR *LiteRider PTC*

All electrically powered vehicles, including power chairs are susceptible to EMI/RFI. This interference could result in abnormal or unintended movement of your Golden *LiteRider PTC*.



**WARNING** **Unintended movement or brake release could cause an accident or injury.**

The FDA has determined that each make and model of power chair can resist EMI/RFI to a certain level. The higher the level of immunity, the greater the degree of protection from EMI/RFI measured in volts per meter (V/m). The FDA has also determined that current technology is capable of providing 20 V/m of immunity to EMI/RFI, which would provide useful protection against common sources of interference. This product has been tested and has passed an immunity level of 20 V/m.

#### EMI/RFI RECOMMENDATIONS



**PROHIBITED!** Do not turn on or use hand-held personal electronic communication devices such as cellular phones, walkie-talkies, or CB radios while your power chair is turned on.

- Be aware of any nearby transmitters (radio, television, microwave, etc.) on your intended route and avoid operation your of power chair close to any of those transmitters.
- Turn off the power if your *LiteRider PTC* is going to be in a stationary position for any length of time.
- Be aware that adding accessories or components or modifying your power chair may make it more susceptible to EMI/RFI.
- If unintended movement or brake release occurs, turn your power chair off as soon as it is safe to do so.
- Report all incidents of unintended movement or brake failure to your Golden Technologies representative or to Golden Technologies.



**WARNING** **TURN OFF YOUR POWER CHAIR AS SOON AS IT IS SAFELY POSSIBLE IF UNINTENDED OR UNCONTROLLABLE MOTION OCCURS OR IF UNINTENDED BRAKE RELEASE OCCURS.**

## IV. ASSEMBLY

---

Your *LiteRider PTC* is shipped partially disassembled in order to maximize the protection of all its parts during the shipping process. Please follow the instructions below to quickly and easily assemble the power chair for your use.

**NOTICE** You will need only basic tools. If you do not have the required tools, or if you do not feel capable of safely assembling your power chair, please contact your local Golden Technologies, Inc. representative.

### Main Components

1. Base with Under-the-Seat Basket
2. Battery Pack
3. Seat Assembly
4. Joystick
5. Foot Plate



**Figure 1**

## IV. ASSEMBLY

---

Before operating or assembling your *LiteRider PTC*, be sure to remove the battery deactivate strip and connect the joystick cable to the VR2 controller. Your *LiteRider PTC* will not power up or operate without completing these steps.

1. Remove the battery pack by pulling up on the handle and remove the battery deactivate strip. See figure 2.



**Figure 2**



**Figure 3**

2. Connect the joystick control to the VR2 power module. See figure 3.



**WARNING** Be sure the joystick cable is securely attached to the unit and that the cable is not able to trail on the ground or become entangled on any surrounding objects while the unit is in use.



**WARNING** The *LiteRider PTC* battery pack weighs 25 pounds. The standard (17 x 16) seat with arms weighs 22 pounds. Removal of arms will reduce the weight of the seat. Please ask for help if you do not feel capable of safely lifting that much weight.

## IV. ASSEMBLY

---

### Seat Installation

1. Fold the seat back down.
2. Grasp the seat firmly on each side, lift the seat and align the seat pin with the hole in the seat post receiver. See figure 4.



*Figure 4*

3. Insert the seat into the seat post.
4. Push down on the seat to lock into place. Move the seat from side to side to make sure it is locked into place.

**NOTICE** To rotate your seat, push down on the seat rotation lever and rotate the seat to the desired position. Release the handle to lock the seat in position.



**WARNING** Be sure the seat is correctly installed and locked before operating your power chair.



**WARNING** Never pull on the arms or use them as a handle to move the power chair as they could inadvertently pull out of the receiver bar causing injury.

## IV. ASSEMBLY

---

### Arm Installation

1. Loosen the arm width adjustment screw from the arm receiver tube at the bottom rear of the seat frame with a 4mm Allen wrench. See figure 5.
2. Insert the arm into the arm receiver tube, so that the arm pad faces toward the front of the unit.

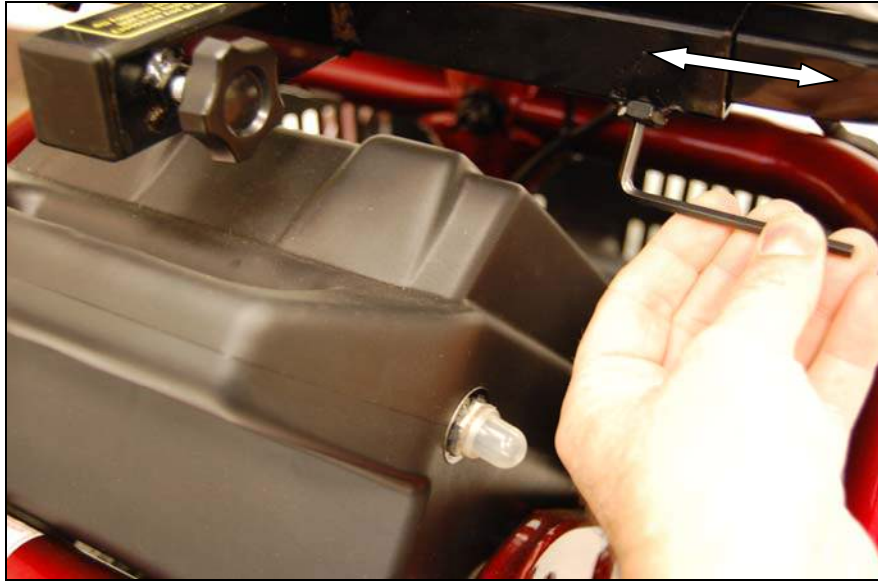

**Figure 5**

3. Adjust the width of the arm.
4. Tighten the arm width adjustment screw to secure the arm in place.
5. Repeat steps 1 – 4 for the opposite side.

### Seat Belt Installation (Optional Equipment)

1. Use a 4mm Allen wrench to remove the arm width adjustment screw from the arm receiver tube at the bottom rear of the seat frame. See figure 5.
2. Insert one of the screws provided with the seat belt through one of the seat belt anchors, reinsert the screw into the receiver tube, and tighten to secure.
3. Repeat steps 1 and 2 for the opposite side of the seat belt.

## IV. ASSEMBLY

---

### Joystick Installation

1. Loosen the joystick bracket adjustment screw located under the armrest. See figure 6.
2. Insert the joystick mounting tube into the joystick bracket under the armrest.
3. Adjust the position of the joystick to a comfortable spot.
4. Tighten the joystick adjustment screw to secure the joystick.



**Figure 6**

**Note:** The joystick may be installed on the left or right arm according to your preference.

## V. DISASSEMBLY and BATTERY REPLACEMENT

To disassemble your *LiteRider PTC*, follow the instructions listed below.



**WARNING** Make certain that the controller power is turned off and that the chair is **NOT** in freewheel mode before attempting to perform disassembly.

### Disassembly

1. Fold the seat back down. *Note: Seat arms can be removed to reduce weight.*
2. Grasp the seat firmly on each side, and lift up to remove.
3. Remove the battery pack by pulling up on the handle. See figure 2 on page 12.
4. Grasp the frame and locking handle; lift the handle to unlock, and lift the frame up and off the drive train. See figure 7.

Note: To reassemble the power chair, simply reverse the process.



**Figure 7**



**GP162 Shown Disassembled**

### Battery Replacement

Should your batteries need replacement; please contact your Golden Technologies representative. Battery replacement requires disassembly of the battery pack and must be performed by a qualified technician.



**MANDATORY!** Use only AGM or GEL-cell batteries.



**Battery Pack**



**WARNING** The battery pack weighs 25 pounds on the *LiteRider PTC*. Please get help if you do not feel capable of safely lifting that much weight.



## VI. COMFORT SETTINGS

You may be spending a great deal of time on your *LiteRider PTC*. To provide you with the maximum seating comfort, Golden Technologies, Inc. has designed this power chair to incorporate the following adjustments for operator comfort.

### COMFORT SETTINGS

- |                   |                            |
|-------------------|----------------------------|
| 1. Seat Height    | 5. Footrest Height         |
| 2. Arm Width      | 6. Joystick Bracket Length |
| 3. Armrest Angle  | 7. Joystick Position       |
| 4. Footrest Angle |                            |



**WARNING** Make certain that the power to your *LiteRider PTC* is turned off before making any adjustments, to eliminate the risk of the joystick being accidentally bumped and activating the power chair.

### Seat Height Adjustment

The seat is a center post design that is easily adjusted for height. See figure 8. To adjust the height to a comfortable level:

1. Remove the seat.
2. Place a 17mm wrench on the lock nut, and insert an 8mm Allen wrench into the bolt.
3. Loosen and remove the bolt, washer and lock nut, noting their placement.
4. Set the seat post to one of the two adjustment positions.

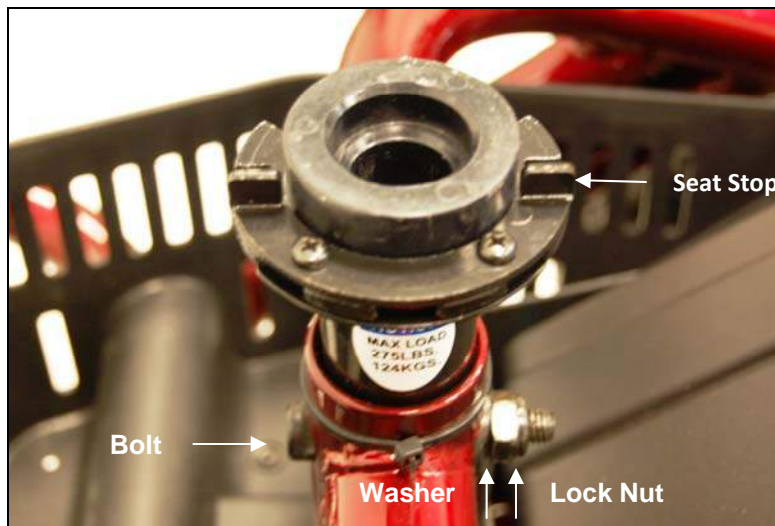

**Figure 8**

5. Reinsert the bolt, washer and lock nut in the same order you remove them and tighten securely.

**Note:** The seat stop must be positioned on the left side of the seat post as shown.

## VI. COMFORT SETTINGS

---

### Arm Width Adjustment

1. Loosen the adjustment screw at the rear of the seat with a 4mm Allen wrench. See figure 9.
2. Slide the arm in or out to the desired width.
3. Tighten the adjustment screw to secure the arm.
4. Repeat steps 1-3 to adjust the opposite arm.

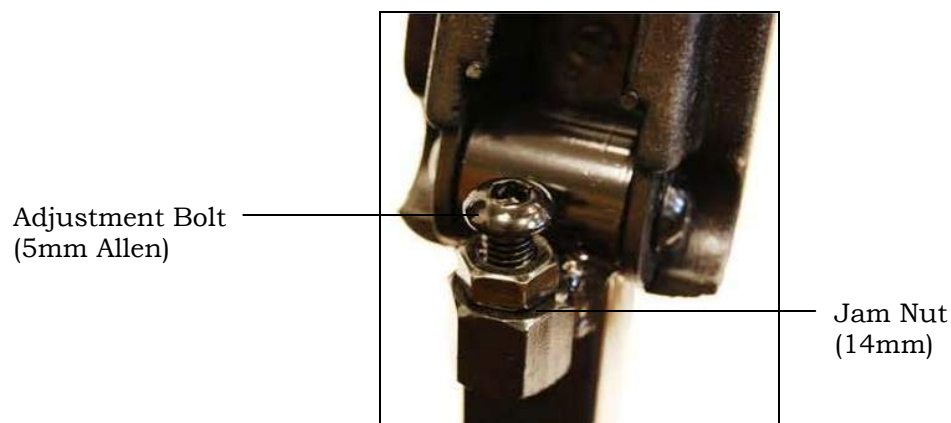

**Figure 9**

**Note:** The backrest can be folded down to minimize chair height during transport.

### Armrest Angle Adjustment

1. Lift armrest up. See figure 10.
2. Turn jam nut counter-clockwise to loosen.
3. Turn the adjustment bolt using a 5mm Allen wrench to raise or lower the armrest-angle. Turning the bolt counter-clockwise will raise the angle. Turning the bolt clockwise will lower the angle. Turn until desired angle is reached.
4. Re-tighten jam nut by turning clockwise.
5. Repeat steps 1-4 on the opposite armrest.



**Figure 10**

## VI. COMFORT SETTINGS

---

### Footrest Angle Adjustment

1. Fold the footrest upward for easy access to the angle adjustment bolt. See figure 11.
2. Turn the jam nut counter-clockwise with a 17mm wrench to loosen.
3. Use an 8mm Allen wrench to turn the adjustment bolt. Turn the adjustment bolt counter-clockwise to increase the footrest angle. Turn the adjustment bolt clockwise to decrease the footrest angle.
4. When the desired footrest angle is reached, re-tighten the jam nut.

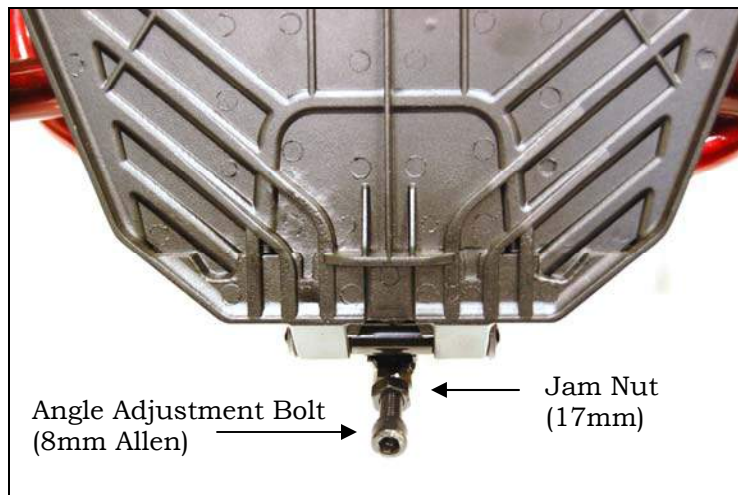

**Figure 11**

### Footrest Height Adjustment

1. Remove front body shroud by lifting it up and off of the power chair base.
2. Use a 10mm socket and 4mm Allen wrench to remove the bolts indicated in figure 12.
3. Slide the footrest to the desired height.
4. Align the bolt holes in the footrest and the footrest bracket.
5. Install and tighten the bolts.

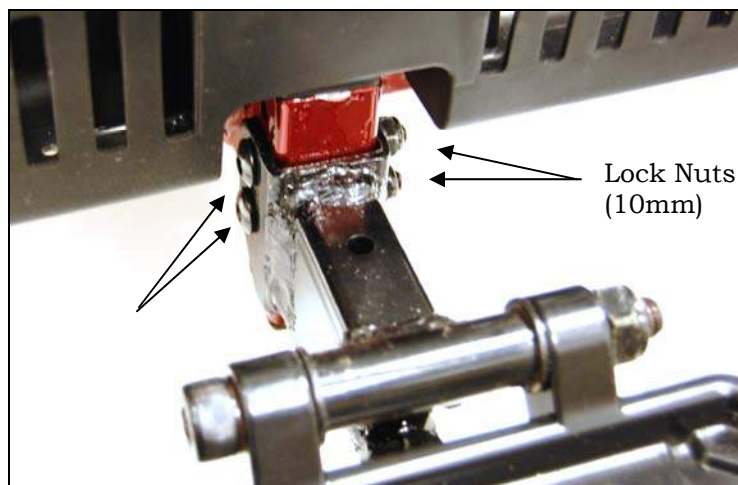

**Figure 12**

## VI. COMFORT SETTINGS

### Joystick Bracket Length Adjustment

1. Loosen the adjustment knob. See figure 13.
2. Slide the joystick holder in or out to the desired position.
3. Tighten the adjustment knob.



**Figure 13**

### Joystick Position

1. Loosen the joystick adjustment screw.
2. Slide the joystick mount forward and remove the joystick.
3. Reposition the joystick and joystick cable to the opposite side of the power chair.
4. Flip up the armrest.
5. Remove the two bolts connecting the joystick bracket to the armrest. See figure 14.

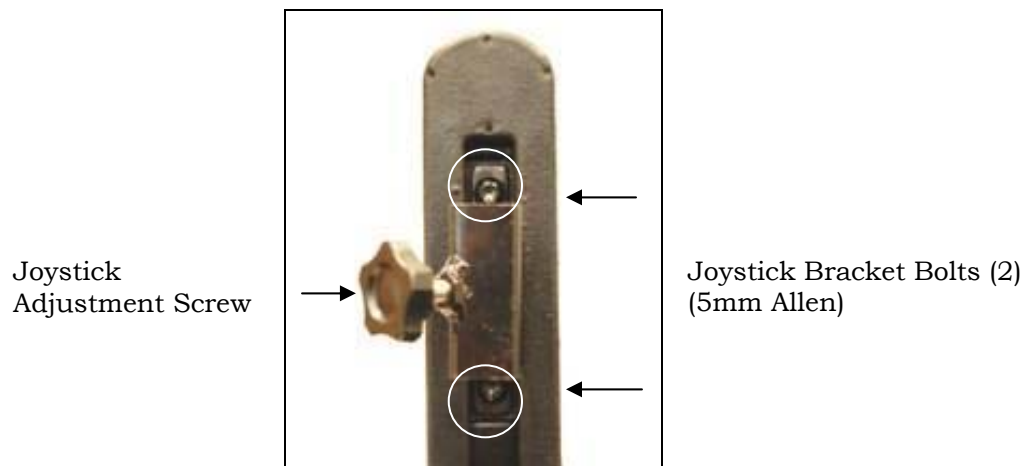

**Figure 14**

6. Place the joystick bracket on the opposite armrest; align the two bolts with the two holes in the armrest, and tighten to secure the bracket to the armrest.
7. Insert the joystick mount into the joystick bracket and adjust to a comfortable position.
8. Tighten the joystick adjustment screw to secure the joystick.

Note: If you do not feel capable of safely making these adjustments, please contact your local Golden representative.

## VII. OPERATION

---



**MANDATORY!** Read and follow the owner's manual.

Your *LiteRider PTC* is simple to operate. However, for your safety and the safety of others, Golden Technologies, Inc. recommends that you carefully read and understand the following operating instructions. We also recommend that you practice operating your *LiteRider PTC* in an area free of any obstacles. Once you have gained confidence in your ability to control your power chair, you will more easily be able to operate it in normal daily conditions.

**▲ CAUTION** Before turning on the power of your *LiteRider PTC*, take note of your environment and set your speed control accordingly. (See “Speed Control Buttons” figure 15 on page 24) For indoor driving, we recommend that you select the lowest speed setting. For outdoor driving, we recommend that you select a speed setting at which you feel comfortable, safe, and in control of your power chair. Familiarize yourself with the features of your *LiteRider PTC* described below and follow the instructions to safely operate your power chair.

### **DRIVING: The Joystick On/Off Switch**

Push the on/off button to turn on the power to your *LiteRider PTC*. See figure 15 on page 24. The 10 LEDs will flash once and a number of LEDs will remain depending on the state of the battery charge.

◆ The LED (Light Emitting Diode) array, that functions as the battery charge gauge, will light up. See “Battery Charging” on pages 29-30.

Pressing the on/off button again will turn off the power to your *LiteRider PTC*.

### **The Speed Control Buttons**

These buttons provide you with a way to control the maximum speed of your *LiteRider PTC*.

◆ Push the “Slow” button repeatedly to set your chair's speed to the slowest setting (recommended for indoor operation). Slowest speed is indicated by one (1) lit LED section on the speed indicator scale.

◆ Push the “Fast” button repeatedly to set your chair's speed to its highest setting. Highest speed is indicated by five (5) lit LED sections on the speed indicator scale.

Note: For your safety, the controller automatically sets the reverse speed, acceleration, and deceleration in proportion to the speed control setting.

## VII. OPERATION

---

### The Joystick

The joystick (see figure 15 on page 24) controls the speed (up to the maximum limit set by the speed control buttons) and direction of your power chair.

Note: When you are not pushing on the joystick, or when you release the joystick, the joystick will automatically return to the neutral position, the chair will decelerate, as the electromagnetic brakes are applied, and come to a smooth stop.

Pushing the joystick away from the neutral (center) position will move your *LiteRider PTC* in the direction that the joystick is pushed.

◆ The farther forward or backward you push the joystick, the faster your power chair will go.

**To operate your power chair, gently push the joystick in the direction in which you want to travel.**

◆ Gentle operation of the joystick will provide you with smoother changes in speed and direction.

◆ Sharp or jerky operation of the joystick will result in quick and drastic changes in direction and speed.

### The Joystick Display

The joystick display (see figure 15 on page 24) is a multifunctional visual display. This display provides three types of information.

1. On/Off status
2. Battery charge level
3. Fault diagnostics

#### 1. On/Off Status

When you turn on the power to your *LiteRider PTC*, the LED array will light up (see figure 15 on page 24).

◆ If the LED array is not lit, the controller and the power chair are not in operating mode.

## VII. OPERATION

---

### 2. Battery Charge Level

The joystick LED array is composed of ten (10) LED's.

- ◆Three (3) red
- ◆Four (4) amber
- ◆Three (3) green

When all ten LEDs are lit continuously, there is a full charge on the batteries. As you use your power chair and the batteries discharge, LEDs in the array will begin to turn off in descending order. A single lit red LED indicates the lowest state of operable charge on the batteries. The batteries should be charged immediately.

Note: To ensure a dependable battery charge, refer to the "Battery Charging" section on pages 29-30. Doing this will prolong the life of your batteries and spare you loss of operational power while you are using your chair normally.

### 3. Control System Status Indication

The joystick LED array is also designed to help you diagnose any problems with the electrical components of your power chair. The LED array does this by flashing on and off in a coded sequence. The battery gauge and maximum speed/profile indicator show the status of the control system.

#### **Battery Gauge is Steady**

This indicates that all is well.

#### **Battery Gauge Flashes Slowly**

The control system is functioning correctly, but you should charge the battery as soon as possible.

#### **Battery Gauge Steps Up**

The wheelchair batteries are being charged. You will not be able to drive the wheelchair until the charger is disconnected and you have switched the control system off and on again.

#### **Battery Gauge Ripples**

The joystick has been displaced (OONAPU) while the control system is switched on. Release the joystick to clear the fault.

Note that joystick OONAPU (**O**ut **O**f **N**eutral **A**t **P**ower **U**p) is not a fault. Simply by removing your hand from the joystick and allowing it to return to the neutral position, the fault will immediately clear. If the condition persists after removing your hand, the joystick may be damaged. Consult a Golden Technologies representative.

## VII. OPERATION

---

### **Battery Gauge Flashes Rapidly (even with the joystick released) See figure 15.**

The control system safety circuits have operated and the control system has been prevented from moving the wheelchair. This indicates a system trip, i.e. the VR2 has detected a problem somewhere in the wheelchair's electrical system.

Please follow this procedure:

- Place the joystick in the center position and turn the control system off and on again to clear the fault. If the fault does not clear, go to the next step.
- Switch off the control system.
- Disconnect and reconnect all connectors on the wheelchair and the control system to make sure they are mated securely.
- Check the condition of the battery.
- If you can't find the problem, go to the "Self-Help Guide" section below.
- Switch on the control system again and try to drive the wheelchair. If the safety circuits operate again, switch off and do not try to use the wheelchair. Contact your Golden Technologies representative for service.

### **Self-Help Guide**

If a system trip occurs, you can find out what has happened by counting the number of LEDs on the battery gauge that are flashing. See page 25.

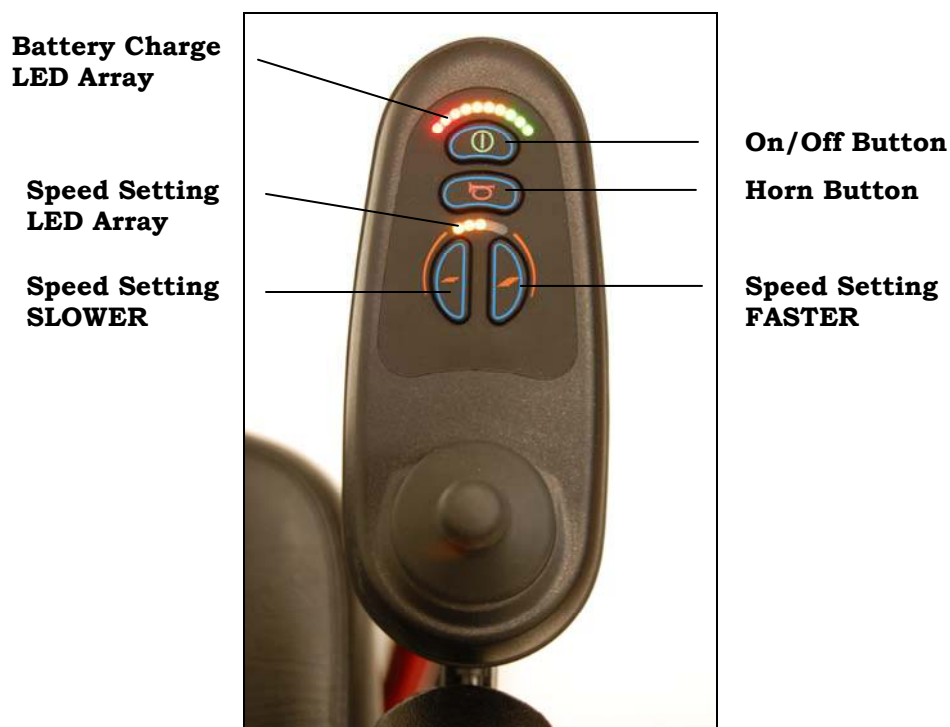

**Figure 15**



## VII. OPERATION

---

### DIAGNOSTICS/TROUBLESHOOTING

Below are a list of trouble-shooting actions. Try to use this list before you contact your Golden Technologies representative. Go to the number on the list which matches the number of flashing LEDs and follow the instructions. If the problem persists after you made the checks described, contact your Golden Technologies representative for further assistance.

**1 LED** - The battery needs charging or there is a bad connection to the battery. Check the connections to the battery. If the connections are good, try charging the battery.

**2 LEDs** - The left hand motor has a bad connection. Check the connections to the left hand motor.

**3 LEDs** - The left hand motor has a short circuit to a battery connection. Contact your Golden Technologies representative.

**4 LEDs** - The right hand motor has a bad connection. Check the connections to the right hand motor.

**5 LEDs** - The right hand motor has a short circuit to a battery connection. Contact your Golden Technologies representative.

**6 LEDs** - The wheelchair is being prevented from driving by an external signal. One possibility is the battery charger is connected. Disconnect the charger.

**7 LEDs** - A joystick fault is indicated. Make sure that the joystick is in the center position before switching on the control system.

**8 LEDs** - A control system fault is indicated. Make sure that all connections are secure.

**9 LEDs** - The parking brakes have a bad connection. Check the parking brake and motor connections. Make sure the control system connections are secure.

**10 LEDs** - An excessive voltage has been applied to the control system. This is usually caused by a poor battery connection. Check the battery connections.

## VII. OPERATION

---

### **Slow or Sluggish Movement**

If the wheelchair does not travel at full speed or does not respond quickly enough, and the battery condition is good, check the maximum speed setting. If adjusting the speed setting does not remedy the problem, then there may be a non-hazardous fault. Contact your Golden Technologies representative.

### **Maximum Speed/Profile Indicator**

This LED array shows the maximum speed setting for the power chair or, if the control system is programmed for drive profile operation, the selected drive profile.

### **Maximum Speed/Profile Indicator is Steady**

The display will vary slightly depending on whether the control system is programmed to operate with drive profiles.

### **Maximum Speed Indication**

The number of LEDs illuminated shows the maximum speed setting. For example, if the setting is speed level 4, then the four left hand LEDs will be illuminated.

### **Profile Indication**

The LED illuminated shows the selected drive profile. For example, if drive profile 4 is selected, then the fourth LED from the left will be illuminated.

### **Maximum Speed/Profile Indicator Ripples Up and Down**

This indicates the control system is locked. Unlock the control system.

### **Locking/Unlocking the Wheelchair**

The VR2 control system can be locked to prevent unauthorized use. The locking method is via a sequence of key presses and joystick movements, as detailed below.

#### **To lock the wheelchair:**

- While the control system is switched on, depress and hold the on/off button.
- After 1 second the control system will beep. Now release the on/off button
- Deflect the joystick forwards until the control system beeps.
- Deflect the joystick in reverse until the control system beeps.
- Release the joystick, there will be a long beep.
- The wheelchair is now locked.

#### **To unlock the wheelchair:**

- Use the on/off button to switch the control system on. The maximum speed/profile indicator will be rippling up and down.
- Deflect the joystick forwards until the control system beeps.
- Deflect the joystick in reverse until the control system beeps.
- Release the joystick, there will be a long beep.
- The wheelchair is now unlocked.

## VII. OPERATION

---

### Maximum Speed/Profile Indicator Flashes

This indicates the speed of the wheelchair is being limited for safety reasons. Contact your Golden Technologies representative

**NOTICE** The VR-2 modules are not user serviceable. **Do not** attempt to repair VR-2 modules.

### FREEWHEEL MODE

- ◆ To disengage the brakes and put your power chair in freewheel mode, push the freewheel levers down. See figure 16.
- ◆ To re-engage the brakes and take your chair out of freewheel mode, pull the freewheel levers up. See figure 16.



*Figure 16*

 **WARNING** Never put your power chair in freewheel mode when it is on a slope or incline of any type.

 **WARNING** Never put your power chair in freewheel mode while you are operating your power chair.

## VII. OPERATION

---

### **THERMAL ROLLBACK**

Your *LiteRider PTC* is equipped with a safety system. A microprocessor monitors the operating temperatures of the controller. In the event of excessive heat occurring in the controller, the controller will decrease the speed of your chair. This is done to reduce the load on the electrical system and allow the components to dissipate heat. The controller will automatically set the chair's speed back to full normal when the operating temperature returns to normal levels.

### **THE MAIN CIRCUIT BREAKER**

The main circuit breaker is another safety feature incorporated into your *LiteRider PTC*. This device monitors the amount of current being drawn from the batteries when the chair is in use. When the motors are heavily strained and too high a current draw is being placed on the batteries, the main circuit breaker will trip and bring your chair to a stop. The main circuit breaker is located under the battery box handle.

### **RESET BUTTON**

If the main circuit breaker trips, please wait for approximately 1 minute and then push the reset button to reset the main circuit breaker. See figure 17.



**Figure 17**

Note: Usually, the thermal rollback feature is more sensitive than the main circuit breaker. We recommend that you turn off the power to the chair and wait for five minutes when the chair suddenly loses speed or power. Doing so will allow the overheated electrical components to cool to their normal operating temperatures.

## VIII. BATTERY CHARGING

---



**WARNING** You must use only the charger that is supplied with your *LiteRider PTC*. The use of any other charger on this power chair will void the warranty. Using unauthorized chargers may also result in severe damage to the batteries and/or damage to the chair. Using the wrong charger may also be a hazard.

### OPERATIONAL RANGE

Depending on the use, the terrain, and the driving conditions, the battery pack will provide up to **9.5** miles of operation on your *LiteRider PTC*.



**WARNING!** Corrosive chemicals contained inside battery.  
Explosive battery conditions exist.



**WARNING!** Charger surface can become HOT.  
Electrical hazard!

### BATTERIES AND CHARGING

Battery maintenance is the most important part of maintaining your power chair. Keeping the batteries fully charged helps to extend battery life. Use the following guidelines to help keep your batteries in optimum condition.

**IMPORTANT!** New batteries **MUST** be fully charged prior to the initial use of your power chair.

**Charge new batteries for 12 hours even if the battery gauge already shows a full charge. This is to condition your new batteries for maximum performance.**

- For daily use, keep batteries fully charged. We recommend that you plug in the off-board charger after each use and charge 6-8 hours.

**“For best results please charge your batteries overnight after every use.”**

- If you are not going to use the power chair for more than a week, **fully charge** the batteries and then disconnect them from the power chair. See figure 2 on page 12.

### NOTICE

#### Charging Guidelines Checklist to Maximize Battery Life

- ✓ Use only the automatic off-board charger supplied for all routine charging.
- ✓ Never use an automotive or wet type charger.
- ✓ Avoid deep discharges and never drain the batteries completely.
- ✓ Do not leave batteries in a low state of charge for extended periods. Charge a discharged battery as soon as possible.
- ✓ Fully recharge batteries regularly.
- ✓ Always store batteries fully charged.
- ✓ Check stored batteries once a month and recharge as necessary.

## VIII. BATTERY CHARGING

### CHARGING THE BATTERIES

Your *LiteRider PTC*'s charging system is designed for your safety and for your convenience. Follow the steps below to recharge the batteries.

1. Position your *LiteRider PTC* close to a standard wall electrical outlet.
2. Turn off the power on the joystick.
3. Insert the matching charger plug into the joystick's charging socket that is located at the front of the joystick or alternatively into the battery pack. See figures 18 and 19.



**Figure 18**



**Figure 19**

4. Insert the plug at the other end of the charger power cord into a standard electrical wall outlet. (Power to the charger indicated by a red LED).

**Note:** Make sure the standard electrical wall outlet is not controlled by a light switch causing the charger to accidentally shut off when it is activated.

5. Disconnect the charger power cord from the wall outlet and from the joystick charging socket when the batteries are fully charged.

**Note:** The batteries should be fully charged in eight hours. A full charge is indicated, when the charge LED turns green and all 10 joystick LEDs are lit when the joystick is turned on.

Alternatively, you may charge the battery pack directly.

1. Remove the battery pack from the power chair.
2. Locate the charger port on the side of the battery pack and swing the cover open.
3. Plug the charger into the battery pack socket.
4. Insert the plug at the other end of the charger power cord into a standard electrical wall outlet.
5. Disconnect the charger power cord from the wall outlet and from the battery pack charging socket when the batteries are **fully charged**.

## IX. CARE AND MAINTENANCE

---

### ROUTINE MAINTENANCE

The Golden *LiteRider PTC* is virtually maintenance free. All of the bearings are permanently lubricated and sealed. No additional lubrication is required. There are, however, several things that you can do to help keep up the appearance and maintain the performance of your power chair.

We recommend that you periodically check the following:

**Tire Tread:** Regularly visually inspect the tire tread. If the remaining tread is less than 1/32 of an inch, have your local Golden representative replace the worn tires.

**Joystick and Controller:** Protect the joystick and controller from adverse weather conditions. Moisture will damage the controller and void your power chair's warranty.

### CLEANING YOUR *LiteRider PTC*

#### Tires

Clean the tires with ordinary kitchen-type cleaners and a damp cloth. Do not use solvents on the tires. Solvents can cause the tire material to break down or become too soft.

#### Body

- Clean the body of your power chair with a damp cloth. Do not hose down your scooter! Dry with a clean soft cloth.
- Use cool water mixed with a mild soap to remove dirt and oils.
- Buff by hand with a soft cloth.

#### Vinyl Seat

Clean with a mild soap or mild detergent and a damp cloth. A vinyl cleaner may also be used.



**WARNING** Do not use free-flowing water to clean your *LiteRider PTC*. Water and extreme temperatures are the main elements that can adversely affect your power chair and its performance.

#### Water, Rain, Sleet, and Snow

Water, in any form, will cause electronic malfunction or corrosion of the electrical components, connections, and the chair frame.

#### Temperature

- ◆ At extremely low temperatures, the batteries of your power chair may freeze, preventing your *LiteRider PTC* from operating.
- ◆ At extremely high temperatures, your power chair may operate at slower speeds due to the controller's thermal rollback feature that is designed to prevent damage to the motors and to the other electrical components of the chair.

## **X. RIDING YOUR *LiteRider PTC***

---

### **Control Through Tight Spots**

As you use your *LiteRider PTC* to increase your mobility, you will undoubtedly encounter some obstacles that will require practice to negotiate smoothly and safely. Below are some common obstacles that you may meet during the daily use of your power chair. Listed with those obstacles are some driving tips that should help you conquer those obstacles. Learn and follow those tips, and with surprising ease you will soon be in control of your power chair as you maneuver it through doors, up and down ramps, up and over curbs, through grass and gravel, and up and down inclines.

#### **Doors**

- Approach any unfamiliar door slowly.
- Notice if the door has a door knob or a push bar.
- Determine if the door opens towards you or away from you.
- Do not try to use your own strength to open the door. Learn to use the power of your power chair to do the majority of the work for you.

#### **If the door opens away from you:**

1. Use one hand to turn the door knob or to operate the push bar.
2. Use your other hand to control the power chair by gently operating the joystick to move your power chair slowly forward.
3. Use your arm to push the door gently open.
4. Drive through the doorway.
5. If it is a self-closing door, it will close behind you.
6. If it is not a self-closing door, stop your power chair when it is clear of the door and use your hand to push the door closed.

#### **If the door opens towards you:**

1. Use one hand to turn the door knob or to pull the handle.
2. Keep your grip on the door knob or on the handle.
3. Use your other hand to control the power chair by gently operating the joystick to move your power chair slowly backward.
4. Allow the power of your *LiteRider PTC* to pull the door completely open.
5. When the door is completely open, stop your power chair.
6. Drive through the doorway while keeping your hand on the door to prevent it from hitting or blocking your power chair.
7. If it is a self-closing door, it will close behind you.
8. If it is not a self-closing door, pull it closed behind you.



## X. RIDING YOUR *LiteRider PTC*

---

### Ramps

Because of the American Disabilities Act (ADA), many buildings are fitted with ramps that provide access for power chairs and for other mobility vehicles.



**MANDATORY!**

**Please read and thoroughly understand “Safety Rules” and “Driving On An Incline” sections of this manual.**



**LiteRider PTC**

## XI. TECHNICAL SPECIFICATIONS

Specification	LiteRider PTC
Model Number	GP-162
Medicare Code	N/A
Weight capacity	300 lbs.
Drive Wheels	Rear
Maximum speed	3.5 mph
Operating Range <sup>1</sup>	9.5 miles
Ground Clearance	2.5 in.
Turning Radius	26 in.
Type Batteries	2-18 AH
Colors	Red
Freewheel Mode	Yes
Electronic Speed Control	Yes
Electro-Mechanical Brakes	Yes
Charger	Off Board
Controller	PG VR-2 50 Amp Remote
Length	33 in.
Width	22.5 in.
Height (ground to top of back of seat)	33.0" – 34.0"
Height (ground to top of back of headrest)	N/A
Ground to top of Seat	20.5" – 21.5"
Number of Seat Height Adjustments	2
Size of Increments	1.0 in.
<b>Weight of Unit: (assembled)</b>	116 lbs.
Front Half	34 lbs.
Rear Half	35 lbs.
Seat with Arms	22 lbs.
Batteries	25 lbs/pack

## XI. TECHNICAL SPECIFICATIONS

Specifications	LiteRider PTC
Model Number	GP-162
<b>Tires:</b>	Flat Free
Front	N/A
Rear	9 in.
Casters	6 in.
Rear Anti-Tip Wheels	3 in.
<b>Standard Seat:</b>	Stadium Style
Slide Seat	N/A
Back Height (no headrest)	16.0"
Back Height (with headrest)	N/A
Width x Depth	17" x 16"
Color	Black Vinyl
<b>Footrest:</b>	Yes
Height adjustable	Yes
Angle adjustable	Yes
<b>Warranty:</b>	
Frame	Five Years
Drive Train	13 Month Warranty
Electronics <sup>2</sup>	13 Month Warranty

\* Notes:

1. Battery range will vary due to rider weight, drive surface, and terrain.
2. Electronics warranty excludes batteries.

Literature is current at the time of printing. Golden Technologies reserves the right to make changes to the product or literature at any time.

## XII. WARRANTY

---

### Consumer Limited Warranty *Power Wheelchairs*

The following warranty is granted only to the INITIAL Consumer who has purchased our product and commences on the Date of Purchase by the Consumer from an Authorized Golden Technologies' Provider. The Consumer must have a warranty registration card filed with Golden Technologies to receive service. This warranty supersedes all previous warranties for all power chair models.

The warranty covers the following power wheelchair models unless otherwise noted:

- |                   |                       |                       |
|-------------------|-----------------------|-----------------------|
| ◆ Alanté Jr GP200 | ◆ Compass GP600       | ◆ Compass TRO GP615   |
| ◆ Alanté GP201    | ◆ Compass GP601       | ◆ Compass GP620       |
| ◆ Alanté DX GP204 | ◆ Compass Sport GP605 | ◆ LiteRider PTC GP162 |
| ◆ Alanté LT GP215 | ◆ Alanté Sport GP205  |                       |

#### **Limited Lifetime Warranty:**

In the event of defective materials or workmanship, Golden Technologies will repair or replace at our option any of the following **structural frame components** found to be defective by an authorized Golden Technologies representative:

- |                |                |              |
|----------------|----------------|--------------|
| ◆ Steel Frame* | ◆ Frame Welds* | ◆ Seat Post* |
|----------------|----------------|--------------|

*\*The GP615TRO, GP620, GP204, GP215, GP205, and the GP162 are warranted for FIVE YEARS.*

#### **Thirteen- Month Limited Warranty:**

For the period of thirteen months from the date of purchase, in the event of defective materials or workmanship, Golden Technologies will repair or replace at our option any of the following **structural frame components** found to be defective by an authorized Golden Technologies representative:

- |                  |                |            |
|------------------|----------------|------------|
| ◆ Caster Beam    | ◆ Caster Forks | ◆ Footrest |
| ◆ Anti-Tip Forks | ◆ Armrests     |            |

For the period of thirteen months from the date of purchase, in the event of defective materials or workmanship, Golden Technologies will repair or replace at our option any of the following **drive train components** found to be defective by an authorized Golden Technologies representative:

- |                          |   |
|--------------------------|---|
| ◆ Motor/Gearbox Assembly | ◆ Brake Assembly (electrical function only) |
|--------------------------|---|

**Note: An increase in operating noise of the motor/gearbox DOES NOT constitute a defect. With normal wear and tear, operating noise is expected to increase.**

For the period of thirteen months from the date of purchase, in the event of defective materials or workmanship, Golden Technologies will repair or replace at our option any of the following **electronic assemblies** found to be defective by an authorized Golden Technologies representative:

- |                         |                   |  |
|-------------------------|-------------------|--|
| ◆ Electronic Controller | ◆ Battery Charger | ◆ Wire Harness(es)<br>(excludes boot covers) |
|-------------------------|-------------------|--|

**NOTICE** While charging batteries, it is normal for the battery charger to heat up. Heat coming from the battery charger DOES NOT constitute a defect.

## XII. WARRANTY

---

### Consumer Limited Warranty *Power Wheelchair (continued)*

For the period of thirteen months from the date of purchase, in the event of defective materials or workmanship, Golden Technologies will repair or replace at our option any of the following **parts** found to be defective by an authorized Golden Technologies representative:

- |   |   |   |
|---|---|---|
| <ul style="list-style-type: none"> <li>◆ Bearings</li> <li>◆ Bushings</li> <li>◆ Seat swivel mechanism</li> </ul> | <ul style="list-style-type: none"> <li>◆ Rubber Components (excludes tires and all wear parts)</li> </ul> | <ul style="list-style-type: none"> <li>◆ Plastic Components (excludes body &amp; all wear parts)</li> </ul> |
|---|---|---|

Items not mentioned or listed are covered at the discretion of Golden Technologies. Any accessories, standard or optional, supplied by Golden Technologies, are covered for a period of one year from the date of purchase with the particular unit.

#### **Warranty Exclusions:**

Golden Technologies does not provide warranty on any of the following items which may require replacement due to the normal wear and tear of day to day usage:

- |  |   |  |
|--|---|--|
| <ul style="list-style-type: none"> <li>◆ Tires and Tubes</li> <li>◆ ABS Plastic Shrouds</li> <li>◆ Armrest Pads</li> </ul> | <ul style="list-style-type: none"> <li>◆ Motor Brushes</li> <li>◆ Bulbs/Fuses</li> <li>◆ Battery Cases</li> </ul> | <ul style="list-style-type: none"> <li>◆ Brake Pads</li> <li>◆ Upholstery</li> </ul> |
|--|---|--|

This warranty also excludes the following:

- ◆ Batteries (Please consult battery manufacturer for any implied warranty).
- ◆ Loss or theft of components.
- ◆ Damage caused by:
  - Battery fluid spillage or leakage.
  - Abuse, misuse, accident or negligence.
  - Improper operation, maintenance or storage.
  - Commercial use or use other than normal.
  - Repairs and/or modifications made to any part without the specific consent of Golden Technologies.
  - Exceeding the specified weight capacity of the unit.
  - Accessories other than those supplied or approved by Golden Technologies.
  - Failure to adhere to the product instructions.
  - Acts of Nature, such as lightning strikes, earthquakes, etc....
  - Circumstances beyond the control of Golden Technologies.
- ◆ **ANY PARTS ALTERED OR REPAIRED BY UNAUTHORIZED PERSON.**

#### **Warranty Service:**

Warranty Service must be performed by an authorized Golden Technologies representative. Golden Technologies reserves the right to replace warranted part(s) with refurbished or new part(s) at our discretion. All labor charges, service calls, transportation costs or any other charge(s) associated with the installation of any warranted part(s) are the responsibility of the consumer. Warranty is for the replacement of the parts only and does not include freight for the replacement parts. Consumers are not to return any item(s) to Golden Technologies without prior written authorization. Any damages incurred while warranted part(s) are in transport are the sole responsibility of the consumer.

**There is no other express warranty.**

Implied warranties, including those of merchantability and fitness for a particular purpose are excluded. Liabilities for consequential damages are excluded.

This warranty gives you specific rights and you may also have other rights which may vary from state to state.