

IVC™ Bariatric Bed

en **Model BAR600IVC**
User Manual

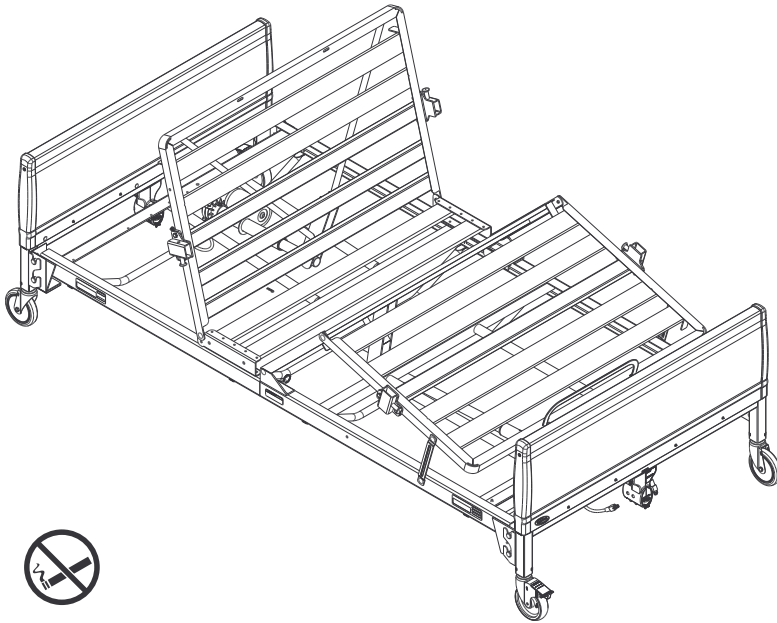

This manual **MUST** be given to the user of the product.
BEFORE using this product, read this manual and save for future reference.



Yes, you can.®

© 2016 Invacare® Corporation

All rights reserved. Republication, duplication or modification in whole or in part is prohibited without prior written permission from Invacare. Trademarks are identified by ™ and ®. All trademarks are owned by or licensed to Invacare Corporation or its subsidiaries unless otherwise noted.

Making Life's Experiences Possible is a registered trademark in the U.S.A.

Contents

I General	4
1.1 Symbols	4
1.2 Intended Use	4
2 Overview	5
2.1 Label Locations	5
2.2 IVC Bariatric Bed Specifications	7
2.3 Bed Components	8
2.4 Accessories	8
2.5 Operating Conditions	8
3 Safety	9
3.1 General Guidelines	9
3.2 Disposal	16
4 Set-up	17
4.1 Receiving	17
4.2 Unpacking	17
4.3 Inspecting	19
4.4 Assembling/Disassembling Head and Foot Sections	19
4.5 Installing Casters	21
4.6 Installing/Removing Bed Ends	22
4.7 Connecting Crossover Cable	23
4.8 Assembling/Installing/Removing Drive Shaft	24
4.9 Inspecting the Bed	25
4.10 Storing the Bed	26
5 Operation	27
5.1 Operating the Bariatric Bed	27
5.2 Emergency Crank	28
5.3 Optional Bed Rails	29

6 Maintenance	31
6.1 Service Life	31
6.2 Wear and Tear Items	31
6.3 Washing Bed Ends	32
6.4 Cleaning Head and Foot Sections	33
6.5 Maintenance and Cleaning Checklist	34
7 Troubleshooting	35
7.1 Troubleshooting: Mechanical	35
7.2 Troubleshooting: Electrical	36
8 Warranty	37
8.1 Limited Warranty	37

I General

I.1 Symbols

Signal words are used in this manual and apply to hazards or unsafe practices which could result in personal injury or property damage. See the information below for definitions of the signal words.



DANGER!

– Danger indicates an imminently hazardous situation which, if not avoided, will result in death or serious injury.



WARNING!

– Warning indicates a potentially hazardous situation which, if not avoided, could result in death or serious injury.



CAUTION!

– Caution indicates a potentially hazardous situation which, if not avoided, may result in property damage or minor injury or both.



Gives useful tips, recommendations and information for efficient, trouble-free use.

I.2 Intended Use

The bed is intended to be used as a mattress support system. The bed allows for articulation of the head and foot sections to provide different positions for the patient. It is intended to be used in home care and long term care facilities.

2 Overview

2.1 Label Locations

⚠ WARNING

The Bariatric Bed is NOT designed to be used as a patient transport. When transporting a patient, use an approved patient transport. Otherwise, injury or damage may result.

P/N 1098347

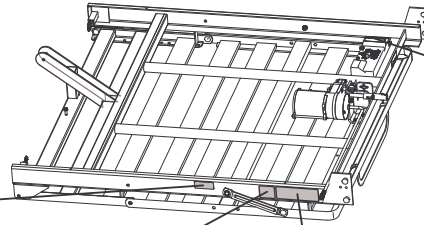

**FOR HOUSEHOLD/
RESIDENTIAL OR
PUBLIC OCCUPANCY
USE PER UL962**

Part No. 1164965

⚠ WARNING

For proper grounding, junction box **MUST** be securely connected to the bed with metal screws and spacer provided or electrical shock could occur.

1108103

⚠ WARNING		⚠ DANGER: RISK OF INJURY OR DEATH	
<p>BEFORE using the bed, READ and UNDERSTAND the User Manual for proper operation and safety procedures. Documentation can be obtained at:</p> <ul style="list-style-type: none"> • www.invacare.com • ph (800) 333-6900 • One Invacare Way, Elyria OH 44036-2125 	<p>SAFE WORKING LOAD</p> <p> = 700 lbs (317.5 kg)</p>	<p>MAX PATIENT WEIGHT</p> <p> = 600 lbs (272 kg)</p>	<p>The combined weight of the patient [600 lbs (272 kg) max patient weight], mattress, bedding, and all accessories MUST not exceed Safe Working Load of 700 lbs (317.5 kg).</p>
		<p>Bed accessories designed by other manufacturers have NOT been tested by Invacare. Use of NON-Invacare bed accessories may result in injury or death.</p> <p>- Use ONLY Invacare rails, mattresses, bed extenders and other accessories with Invacare bed products.</p> <p><small>1098343</small></p>	

CAUTION
 All cable connections **MUST** be aligned properly. Align locking levers with locking tabs for proper connection. Mis-alignment of cable connections will cause permanent product damage.

Head Motor Cable Locking Lever Locking Tab Crossover Cable

P/N 1171770

See reverse side for instructions on correct cable length.

Junction Box

Head End of Bed Foot End of Bed

Head Actuator

WARNING
 If this cable is too short and does not reach head actuator cable or if this cable is too long creating excess cable length after installation, **DO NOT** use this cable. Call customer service at 1-800-333-6900 to obtain correct length cable.

P/N 1134870

Attached to Crossover Cable

Serial Number
 Located Here or
 (Either Side)

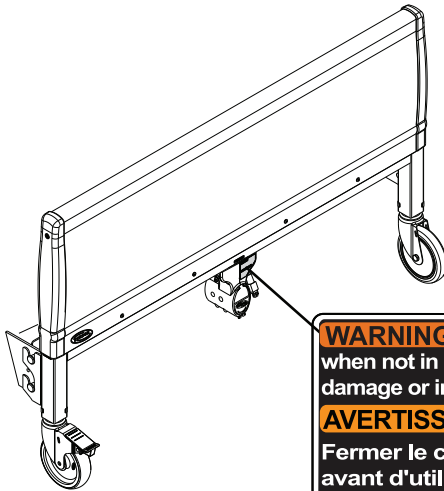

WARNING Close cover when not in use. Otherwise, damage or injury may occur.

AVERTISSEMENT
 Fermer le couvercle avant d'utiliser, sans quoi des blessures peuvent survenir.

P/N 117179

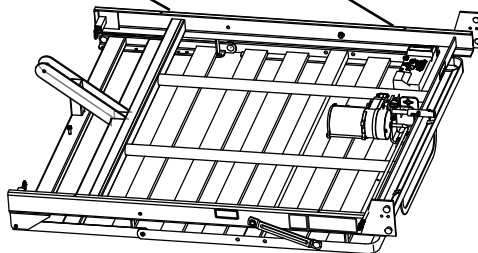

2.2 IVC Bariatric Bed Specifications

BED END HEIGHT	
MINIMUM:	26 inches
MAXIMUM:	34 inches
DECK HEIGHT	
MINIMUM (DOWN POSITION):	14 inches
MAXIMUM (UP POSITION):	23 inches
BED	
OVERALL LENGTH:	88 inches
WIDTH:	42 inches
SPLIT SPRINGS TO ENDS	
HEAD:	43 inches
FOOT:	45 inches
SHIPPING WEIGHT	275 lbs
WEIGHT CAPACITY	
OCCUPANT:	600 lbs
SAFE WORKING LOAD:	700 lbs (Including accessories, mattress, occupant and any other objects positioned on the bed)



Height from floor to bed deck.



For household/residential or public occupancy use per UL 962.

Bed is NOT for hospital use and was not designed to meet hospital standards.

Only use bed indoors.



WARNING!

Risk of Injury or Damage

The weight limit of the occupant of the bed CANNOT exceed 600 pounds. To avoid injury and/or damage from bed collapse:

- The TOTAL weight limit of the bed (including accessories, mattress, occupant and any other objects positioned on the bed) cannot exceed 700 pounds (Safe Working Load).



WARNING!

Risk of Injury or Damage

Patients that weigh less than 350 pounds have an increased risk of entrapment. To avoid injury or damage from entrapment:

- Patients that weigh less than 350 pounds should not use the IVC Bariatric Bed.

2.3 Bed Components

- Head spring with one motor (BAR5000IVC)
- Foot spring with two motors (BAR5490IVC)
- Bed Ends (BAR5301IVC)

2.4 Accessories



WARNING!

Risk of Injury or Damage

To avoid injury or damage from misuse:

- DO NOT install the accessories without reading and understanding all of the instructions in the instruction sheet that accompanies them.

Accessories are subject to change. Contact Dealer or Invacare for current list.

DESCRIPTION	MODEL NUMBER
BED RAIL, HALF LENGTH	BAR6640IVC
	BAR6640P
TRAPEZE	BARTRAP
MATTRESS	BARMATT42

2.5 Operating Conditions

RECOMMENDED STORAGE AND SHIPPING TEMPERATURE	-22°F to 158°F (-30°C to 70°C) up to 93% relative humidity, non condensing
RECOMMENDED OPERATING TEMPERATURE	41°F to 104°F (5°C to 40°C) 15% to 93% relative humidity, non condensing
RECOMMENDED ATMOSPHERIC PRESSURE	700 hpa to 1060 hpa

3 Safety

3.1 General Guidelines



DANGER!

Risk of Death, Injury or Damage

Improper use of this product may cause injury or damage.

- If you are unable to understand the warnings, cautions or instructions, contact a healthcare professional, dealer or technical personnel before attempting to use this equipment.
- Do not use this product or any available optional equipment without first completely reading and understanding these instructions and any additional instructional material such as user manuals, service manuals or instruction sheets supplied with this product or optional equipment.

Continued use of the product with damaged parts could lead to the product malfunctioning, causing injury to the user and/or caregiver.

- Check ALL product components and carton for damage, and test components before use. DO NOT use product if components are damaged or if product is not working properly. Contact a qualified technician or Invacare for repair.

To avoid injury or product damage:

- Set-up and Assembly instructions MUST be performed by qualified technicians only. “Qualified Technician Only” sections are marked accordingly.



DANGER!

Risk of Death, Injury or Damage

Lighted cigarettes can cause a fire or other related hazards resulting in death, injury, or damage.

- Do not smoke while using this product.
- Do not allow others to smoke near this product.



DANGER!

Risk of Death, Injury or Damage

Bed accessories designed by other manufacturers have NOT been tested by Invacare. Use of NON-Invacare bed accessories may result in injury or death.

- Use ONLY Invacare rails, mattresses, bed extenders and other accessories with Invacare bed products.



THE INFORMATION CONTAINED IN THIS DOCUMENT IS SUBJECT TO CHANGE WITHOUT NOTICE.



DANGER!

Risk of Death, Injury or Damage

Improper assembly may cause injury or damage.

Use of incorrect or improper parts, including replacement (service) parts, may cause injury or damage.

- Replacement parts MUST match original Invacare parts.



DANGER!

Risk of Injury or Death

To reduce the risk of electrical shock:

- Always unplug the product from the electrical outlet before cleaning.



DANGER!

Risk of Death, Injury or Damage

To reduce the risk of shock:

- Unplug from the outlet before servicing.
- Close supervision is necessary when the product is used by, or near children and/or disabled persons.
- Use this product only for its intended use as described in these instructions. **DO NOT** use attachments not recommended by the manufacturer.
- If liquid is spilled in or around the product, unplug before cleaning. Clean up the spill and allow the product or the area around the product to dry thoroughly before using the controls again.



DANGER!

Risk of Death, Injury or Damage

To avoid shock, product damage and personal injury:

- **DO NOT** use outdoors.
- Connect this product to a properly grounded outlet only. Refer to 5.1 Operation, page 27.
- **DO NOT** place video equipment such as televisions or computer monitors on product.

Operating Information



DANGER!

Risk of Death, Injury or Damage

To avoid injury or damage when operating product:

- After any adjustments, repair or service and before use, make sure all attaching hardware is tightened securely.
- Close supervision is necessary when the product is used near children or pets **OR** when this product is operated by or near people with physical/mental disabilities. Physically challenged individuals who cannot prevent themselves from rolling/climbing out of the product may require alternative safe means of restraint.
- The product is not designed to be used as a patient transport. When transporting a patient, use an approved patient transport. Otherwise, injury or damage may result.

**WARNING!****Risk of Injury or Damage**

To avoid injury or damage when operating/moving bed:

- ALWAYS ensure that the individual utilizing the bed is positioned properly within the confines of the bed. DO NOT let any extremities protrude over the side or between the bed rails when performing these functions.
- Be aware of potential pinch points when operating bed, rails or other accessories.
- Make sure head and foot sections are connected securely to the bed ends before use.
- The bed is equipped with locking casters. Before using the bed, test the wheel locks to ensure casters lock correctly. When transferring into or out of the bed, ALWAYS lock the casters. Even with casters properly locked, some flooring surfaces (such as tile or wood,) will allow the bed to move under some conditions. Using the bed on these types of surfaces MUST be evaluated by the care provider. DO NOT transfer occupant if bed is not stable. Otherwise, injury and/or damage may occur.
- DO NOT move product with locking casters in LOCKED position.

**DANGER!****Risk of Death, Injury or Damage**

To avoid pinching, crush and collapse hazards from bed deck contact with objects under the bed:

- DO NOT place any objects or let any individual underneath the bed or in between the raised bed frame components at any time.

To avoid risk of death or injury from choking or ingestion of small parts or materials:

- Closely supervise children, pets or individuals with physical/mental disabilities.



Refer to the **Bed Rail Entrapment Risk Notification Guide** at www.invacare.com for additional safety information.

**DANGER!****Risk of Death, Injury or Damage**

Patient entrapment from the use of bed side rails may cause injury or death. To avoid patient entrapment:

- The Invacare mattress MUST fit firmly against the bed frame AND bed side rails to prevent patient entrapment. Follow the manufacturer's instructions. Monitor patient frequently. Read and understand the user manual prior to using the Invacare bed and bed rails. User manuals are available at www.invacare.com or your dealer.
- After any adjustments, repair or service and before use, make sure all attaching hardware is tightened securely.
- Mattress platform, bed ends, pendant and accessories are applied parts.



DANGER!

Risk of Death, Injury or Damage

Conditions such as restlessness, mental deterioration and dementia or seizure disorders (uncontrolled body movement), sleeping problems and incontinence can significantly impact a patient's risk of entrapment. Pediatric patients or patients with small body size may also have an increased risk of entrapment.

- Monitor patients with these conditions frequently.
- Place the mattress deck in the flat position when left unattended.



WARNING!

Risk of Injury or Adverse Health Consequences

Fall hazard exists due to bed height.

- Always leave bed in lowest height when unattended.

Replacement Parts/Accessories



DANGER!

Risk of Death, Injury or Damage

To avoid fire hazards and tubing entanglement:

- Use masked or nasal type oxygen administering equipment only in conjunction with the manual/electric bed. The use of any other type of oxygen administering equipment can result in a fire hazard.
- When using nasal or masked type oxygen administering equipment, the oxygen or air tubing **MUST** be routed and secured properly to ensure that the tubing does not become entangled and/or severed during normal operation of manual/electric bed.
- Do not use this bed in Active Treatment “Ether Environments.”



DANGER!

Risk of Death, Injury or Damage

To avoid fire hazards, injury or damage:

- **DO NOT** use product with flammable gases. Explosion may occur.



WARNING!

Risk of Injury or Damage

To avoid injury or damage from misuse or entrapment:

- Read and understand the instructions or label provided with mattress.
- If you do not understand the instructions or if instructions are missing, contact the mattress manufacturer.



DANGER!

Risk of Death, Injury or Damage

To avoid entrapment, product damage, and/or personal injury:

- Invacare recommends that the mattress be centered on the bed frame. Otherwise, individuals may become trapped between the bed rail and the bed frame.
- **ALWAYS** test to make sure that the side rails are properly and securely in place before using. Otherwise, injury or damage may occur.

**WARNING!****Risk of Injury or Adverse Health Consequences**

Fall hazards exists due to the use of NON-Invacare mattresses. Non-Invacare mattresses are potentially incompatible with Invacare beds.

- To avoid injury, ensure that only Invacare mattresses are used with Invacare beds at all times.

**DANGER!****Risk of Death or Injury**

An increased risk of patient entrapment may occur over time due to mattress compression.

- Periodically monitor gaps between the bed, mattress and/or bed rail. Where gaps occur, patient entrapment is possible and the mattress should be replaced.

**DANGER!****Risk of Death, Injury or Damage**

To avoid entrapment, product damage and/or personal injury:

- When used with a manual/electric bed, the bed rails DO NOT fall under any weight limitations. Bed rails can be deformed or broken if excessive side pressure is exerted on the bed rails. These bed rails are used for the purpose of preventing an individual from inadvertently rolling out of bed. The bed rails are not intended nor may be used for restraint purposes. If an individual is capable of injuring himself/herself, a physician or a healthcare professional should be consulted for alternative means of safe restraint.
- After raising/lowering the head/foot end of the electric bed, check the distance between the bottom of the bed rail and the mattress. If there is excessive distance between the bottom of the bed rail and the mattress in which individuals may become entangled, adjust the height of the bed rail (if applicable), or provide alternative means of patient protection.
- DO NOT use the side rails as push handles for moving the electric bed.
- Replacement mattresses and bed side rails with dimensions different from the original equipment supplied or specified by the bed frame manufacturer are not interchangeable. Variations in bed side rail design, width and thickness or firmness of the mattress could cause/contribute to entrapment.

**DANGER!****Risk of Death, Injury or Damage**

- To avoid injury or damage from misuse or entrapment:
- Proper patient assessment and monitoring, and proper maintenance and use of equipment is required to reduce the risk of entrapment. Variations in bed rail dimensions and mattress thickness, size or density could increase the risk of entrapment. Visit the FDA website at <http://www.fda.gov> to learn about the risks of entrapment. Review “A Guide to Bed Safety”, published by the Hospital Bed Safety Workgroup. Use the link located under each bed rail product entry to access this bed safety guide.
 - Refer to the user manuals for beds and rails for additional product and safety information.
 - Patient entrapment from the use of bed side rails may cause injury or death. The Invacare mattress **MUST** fit firmly against the bed frame **AND** bed side rails to prevent patient entrapment. Follow the manufacturer’s instructions. Monitor patient frequently. Read and understand the User Manual prior to using this equipment. Invacare manuals are available at www.invacare.com or your dealer.
 - An increased risk of patient entrapment may occur over time due to mattress compression. Periodically monitor gaps between the bed, mattress, and/or bed rail. Where gaps occur, patient entrapment is possible and the mattress should be replaced.

Electrical**WARNING!****Risk of Death, Injury or Damage**

Shock hazards and risk of fire exist due to use of improper extension cord and use of three prong adapters.

- To avoid injury or product damage, when using an extension cord, use only a UL approved three prong extension cord having at least 16 AWG (American Wire Gauge) wire and the same or higher electrical rating as the product being connected.
- **DO NOT** use three prong to two prong adapters

**WARNING!****Risk of Injury or Damage**

To avoid product damage and personal injury:

- Disconnect pendant when not in use and store out of reach of children.

Grounding Information



WARNING!

Risk of Shock Injury

Electric beds are equipped with three prong (grounding) plugs for protection against possible shock hazards. Where a two prong wall receptacle is encountered, it is the personal responsibility and obligation of the customer to contact a qualified electrician and have the two prong receptacle replaced with a properly grounded three prong wall receptacle in accordance with the National Electrical Code.

- If you must use an extension cord, use only a three prong extension cord having the same or higher electrical rating as the product being connected. **DO NOT**, under any circumstances, cut or remove the round grounding prong from any plug used with or for Invacare products.
- Junction box **MUST** be securely connected to the bed with metal screws and the spacer provided for proper grounding. Otherwise, electrical shock may occur.



WARNING!

Risk of Injury or Damage

To avoid injury or damage from improper grounding or using damaged parts:

- **DO NOT** operate the product if the cord or outlet is damaged.
- **DO NOT** operate the product if any motor has malfunctioned or is damaged in any manner.

Radio Frequency Interference



Use of portable and mobile RF communications equipment can affect medical electrical equipment



WARNING!

Risk of Product Damage

Electronic equipment may be influenced by Radio Frequency Interference (RFI).

- Caution should be exercised with regard to the use of portable communications equipment in the area around such equipment.
- If RFI causes erratic behavior, unplug the product immediately. Leave unplugged while transmission is in progress.



WARNING!

Risk of Product Damage

The use of accessories, transducers, cords and cables other than those specified by the manufacturer, may result in increased emissions or decreased immunity of this bed.

- This product should not be used adjacent to or stacked with other equipment and that if adjacent or stacked use is necessary, this product should be observed to verify normal operation in the configuration in which it will be used.

Weight Limitations



DANGER!

Risk of Death, Injury or Damage

To avoid bed collapse and resulting injury or damage:

- The weight limit of the occupant of the bed **CANNOT** exceed 600 pounds. The **TOTAL** weight limit of the bed (including accessories, mattress, occupant and any other objects positioned on the bed) cannot exceed 700 pounds (Safe Working Load).
- **NEVER** permit more than one individual on the bed at any time.
- Body weight should be evenly distributed over the surface of the bed. **DO NOT** lay, sit or lean in such a way that your entire body weight is placed only on raised head or foot sections of the bed. This includes when repositioning or transferring in or out of bed.

3.2 Disposal

Follow local governing ordinances and recycling plans regarding disposal of the product or components normally used in operation. The product does not generate waste or residue in operation. Any accessories not part of the product **MUST** be handled in accordance with the individual product marking for disposal.

This product has been supplied from an environmentally aware manufacturer that complies with the Waste Electrical and Electronic Equipment (WEEE) Directive 2012/19/EC.

This product may contain substances that could be harmful to the environment if disposed of in places (landfills) that are not appropriate according to legislation.

Please be environmentally responsible and recycle this product through your recycling facility at its end of life.

4 Set-up

4.1 Receiving



WARNING!

Risk of Injury or Damage

“Qualified Technician Only” sections are marked accordingly.

- Set-up and Assembly instructions **MUST** be performed by qualified technicians only.

1. Count cartons before signing shipping papers.
2. Designate someone at the facility to receive and inspect all merchandise. Use the master order acknowledgment to check off items as they are received.
3. Compare the number of cartons shipped with the number of cartons actually received and note such on the consignee copy of the freight bill. Make sure to have the truck driver sign the copy acknowledging the count.
4. If shortage occurs, **IMMEDIATELY** contact Invacare Customer Service department at (800) 333-6900.

4.2 Unpacking



DANGER!

Risk of Injury or Damage

Continued use of the product with damaged parts could lead to the bed malfunctioning, causing injury to the user and/or caregiver.

- Check ALL product components and carton for damage, and test components before use. In case of damage or if the product is not working properly, contact a qualified technician or Invacare for repair.



WARNING!

Risk of Injury or Damage

To avoid damage or personal injury:

- **DO NOT** plug the power cord into a power source until assembly is complete.
- **DO NOT** attempt to operate product controls prior to completion of assembly.

The bed is contained in three cartons.

1. Remove any loose packing from the cartons.
2. Carefully remove all components from the cartons.

Unpacking Bed Ends

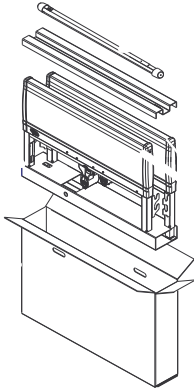

- I. The bed end carton (A) includes:
 - Two bed ends (B)
 - Four casters (C) (two locking and two non-locking casters)
 - One drive shaft assembly in two pieces (D)

Unpacking Head and Foot Sections

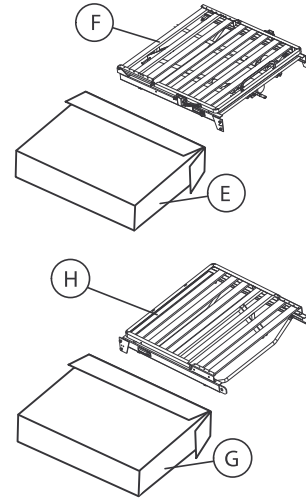

- I. The foot section carton (E) includes:
 - One foot section (F)
 - One emergency crank handle
2. The head section carton (G) includes:
 - One head section (H)



Not shown — Packing inserts, junction box with cord, motors with cables attached, pendant, emergency crank handle and user manual.

4.3 Inspecting



DANGER!

Risk Of Injury Or Damage

To avoid injury or damage, inspect the following and contact a qualified technician or Invacare if any of the following issues are present:

- Pendant covering is cracked or damaged.
- Power cord or plug have cuts or damage.
- Motor cables have cuts or damage.
- Junction box or connectors are damaged.
- Emergency crank is missing or damaged.



DANGER!

Risk Of Injury Or Damage

To avoid injury or damage:

- Ensure that the connectors are plugged into the junction box and fit properly.

4.4 Assembling/Disassembling Head and Foot Sections



WARNING!

Risk of Injury or Damage

To avoid injury or damage:

- DO NOT attempt to operate product controls prior to completion of assembly.

Assembling



No tools are required to assemble this product.

1. Remove the head section of the bed from the packing carton.
2. Remove the foot section of the bed from the packing carton.



Place the head and foot sections on a flat surface so that the motor guards on the bottom of the frame are supporting the section.

3. Remove tie-wraps  securing the cables for shipping.



4. Align the inside of the head section with the inside of the foot section.

5. Push the head section towards the foot section so that the head section frame slides into the foot section frame and the locking pins engage.



Locking pins are located on the foot section frame and will make an audible click when properly engaged with the head section frame.

6. Ensure the locking pins are properly engaged by attempting to pull the head section from the foot section. If the sections separate, repeat STEP 5-6 until the locking pins are secure.
7. Install the bed ends. Refer to 4.6 Installing/Removing Bed Ends, page 22.
8. Connect the crossover cable. Refer to 4.7 Connecting Crossover Cable, page 23.
9. Assemble and install the drive shaft. Refer to 4.8 Assembling/Installing/Removing Drive Shaft, page 24.
10. Activate the bed functions. Refer to 4.9 Inspecting the Bed, page 25.

Disassembling

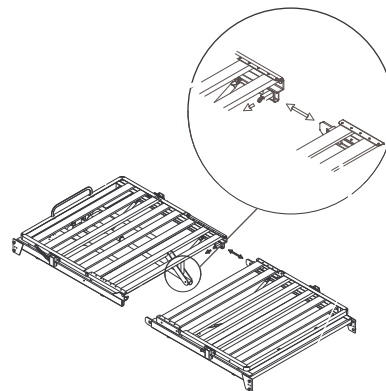

1. Lower the head (A) and foot (B) sections completely. Refer to 5.1 Operating the Bariatric Bed, page 27.
2. Lower the bed to the lowest height.
3. Remove the drive shaft. Refer to 4.8 Assembling/Installing/Removing Drive Shaft, page 24.
4. Disconnect the crossover cable. Refer to 4.7 Connecting Crossover Cable, page 23.
5. Remove both bed ends. Refer to 4.6 Installing/Removing Bed Ends, page 22.



Place the bed on a flat surface so that the motor guards on the bottom of the frame are supporting the bed.

6. Starting with one side of bed, pull the release pin (C) and pull the head section so that it starts to separate slightly from the foot section.
7. On the opposite side of bed, pull the release pin.
8. Separate the head section from the foot section.

4.5 Installing Casters



DANGER!

Risk of Injury or Damage

To avoid injury or damage from instability or falling:

- Ensure that the locking casters are installed diagonally from each other and are locked.
- The proper casters are provided with the product. **DO NOT** use any other casters with the product.
- The product is equipped with locking casters. Before using the product, test the wheel locks to ensure casters lock correctly. Even with casters properly locked, some flooring surfaces (such as tile or wood) will allow the product to move under some conditions. Using the bed on these types of surfaces **MUST** be evaluated by the care provider. **DO NOT** transfer occupant if product is not stable.
- **DO NOT** move product with locking casters in **LOCKED** position.

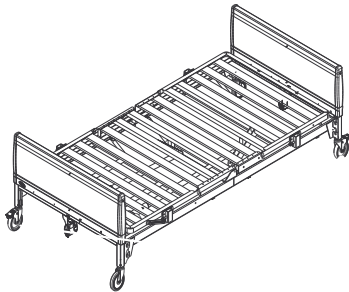

ALWAYS locate locking caster **A** diagonally opposite each on bed frame.

If two locking casters are not included with the bed, contact an Invacare dealer. **DO NOT** assemble the bed.

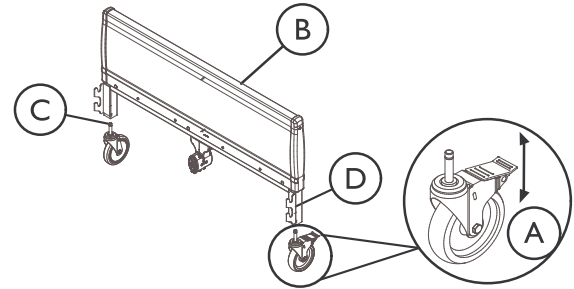

1. To install casters, lay the bed ends **B** flat on the floor.
2. Insert the caster shaft **C** into the caster socket **D**.
3. To prevent excess movement of the bed during assembly, lock each of the two locking casters by pushing down on the caster lock.
4. To unlock each of the two locking casters, push down on the caster lock labeled **OFF**.

4.6 Installing/Removing Bed Ends



WARNING!

Risk of Injury or Damage

To avoid injury or damage while assembling:

- DO NOT place your hand between the head section and the bed end.



Reverse this procedure to remove the bed ends.

1. Stand bed end (A) as close to the head section (B) as possible.
2. With one hand, grasp the head section and raise it until the corner plate head rivets (C) of the section are high enough to place into the corner locks (D) on the bed end.
3. Tilt the bed end toward the head section and place the corner plate head rivets into the corner locks.
4. Return the bed end to its full upright position. The corner plate head rivets will lock into place.
5. Stand bed end (E) as close to the foot section (F) as possible.
6. With one hand, grasp the foot section and raise it until the corner plate head rivets (G) of the section are high enough to place into the corner locks (H) on the bed end.
7. Tilt the bed end toward the head section and place the corner plate head rivets into the corner locks.
8. Return the bed end to its full upright position. The corner plate head rivets will lock into place.

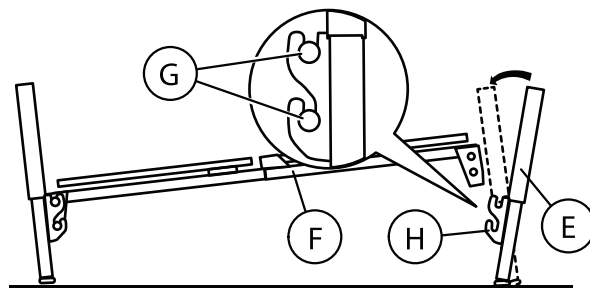
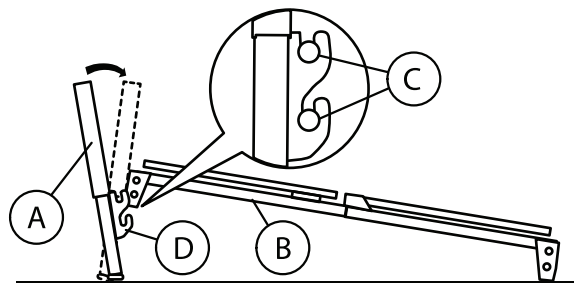

4.7 Connecting Crossover Cable



CAUTION! Risk Of Product Damage

Mis-alignment of cable connections will cause permanent product damage.

- To avoid product damage, all electric cable connections **MUST** be aligned properly. Align locking levers with locking tabs for proper connection.
- **DO NOT** force the connector into the control box.



DANGER! Risk Of Death, Injury, Or Damage

To avoid serious injury or product damage from tripping, entanglement and/or pinched, or severed cords:

- Ensure all cord(s) are routed and secured properly.
- Keep all moving parts, including the main frame, mattress deck, and all drive shafts, free of obstruction (i.e. blankets/sheets, tubing, wiring, cords, etc.) during operation of the product.
- Do not roll the product over the power or pendant cord.



Crossover Cable Definition—The crossover cable is defined as the electric cable that connects the junction box **A** to the head motor actuator.

Reverse this procedure to disconnect the crossover cable.

1. Connect the crossover cable **B** to the cable from the head actuator **C** located on the head end of the bed.

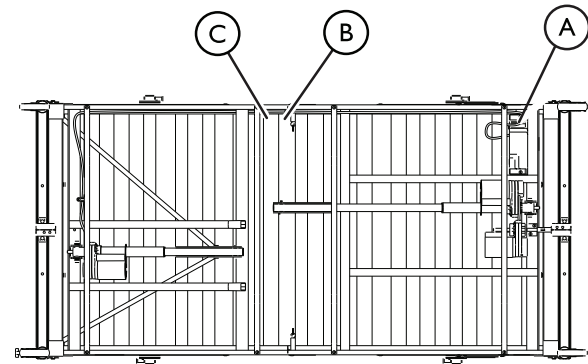

4.8 Assembling/Installing/Removing Drive Shaft



Reverse this procedure to remove the drive shaft.

The drive shaft for Hi/Lo function consists of two sections that are shipped unassembled. The inner drive shaft has a positioning spring button, and the outer drive shaft has multiple holes and a spring-loaded end.

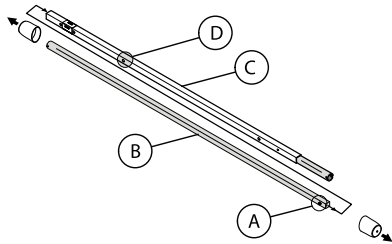

1. Remove the plastic caps from each end of the drive shaft.
2. Press the spring button (A) on the inner drive shaft (B) and insert the inner drive shaft into the outer drive shaft (C).
3. Engage the spring button into the third positioning hole (D).

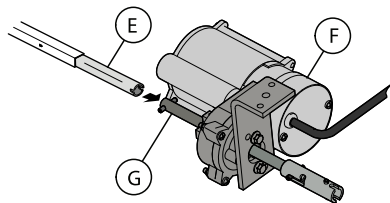

4. Push in on the spring loaded end of the drive shaft (E) and attach to the Hi/Lo motor (F) output shaft (G).

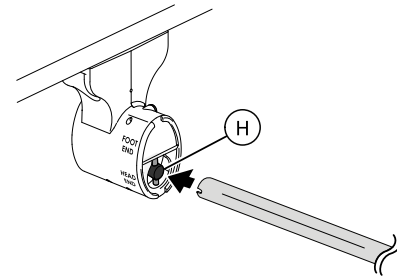

5. Attach the drive shaft to the gear box head end (H) (bottom opening) at the head end of the bed.
6. Ensure the Hi/Lo motor output shaft spring-loaded coupler is properly aligned with the foot end gear box.

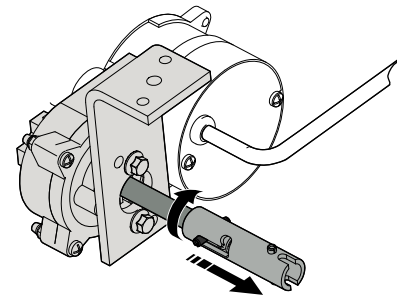

- Release the Hi/Lo motor output shaft spring-loaded coupler by pushing in against the Hi/Lo motor output shaft spring-loaded coupler and turning clockwise.

 The coupling will release and engage the foot end top gear box output shaft cross pins.

- Ensure that all components are securely installed.



WARNING!

Risk of Product Damage

To avoid product damage:

- DO NOT open assemblies such as the motors, pendant, junction boxes or gear boxes. No user serviceable parts are inside. Contact dealer or Invacare for repair/replacement.
- Ensure gear box cover and all other assemblies are closed.
- Unplug the power cord from its power source before performing any maintenance on the product. DO NOT unplug the power cord from the junction box. Damage to cord will result.

4.9 Inspecting the Bed

 All connectors will arrive plugged into the junction box.

- Check all electrical connections on junction box **(A)** at foot end to ensure that all motors are plugged into the correct locations.
- Plug the junction power box cord **(B)** into a 110-volt outlet.
- If equipped with a crossover cable, plug in crossover cable.
- Before placing bed into use, test the bed by operating it through all phases of operation.



(C) = Pendant Cord Connector

(D) = Hi/Lo Motor Connector

(E) = Power Cord Connector

(F) = Head Motor Connector

(G) = Foot Motor Connector

(H) = Pull Tube

(I) = Pendant and Pendant Cord

JUNCTION BOX CONNECTOR IDENTIFICATION

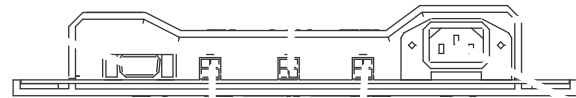
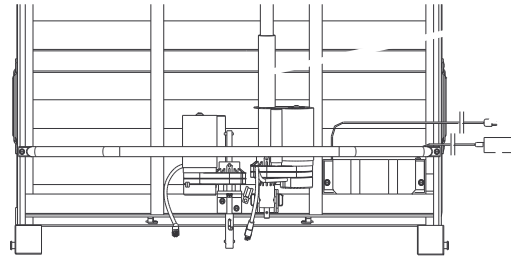

4.10 Storing the Bed



WARNING!

Risk Of Injury Or Damage

To avoid product damage and personal injury:

- DO NOT place other objects on top of the cartons.



WARNING!

Risk Of Injury Or Damage

To avoid product damage and personal injury:

- Disconnect pendant when not in use and store out of reach of children.

If bed is not being assembled immediately, retain the cartons and packaging for storage until ready for assembly.

Store the bed in a dry area.

5 Operation

5.1 Operating the Bariatric Bed



WARNING!

Risk of Injury or Damage

To avoid electrical damage, product damage, shock and/or personal injury:

- DO NOT unplug power cord from junction box.
- When product is not to be used for an extended period, unplug product from the wall outlet.
- Keep all product components and accessories a minimum of 12 inches away from hot or heated surfaces.
- After the product has been assembled and before use, always test to make sure that all sections of the product are properly and securely in place. If any problems arise during the test, recheck all electrical connections and mechanical hook ups and then retest. If the product is not working properly, contact a qualified technician or Invacare for repair.



WARNING!

Risk of Injury or Damage

To avoid unintentionally pressing the pendant buttons and causing injury or damage.

- DO NOT place pendant under or between objects.



WARNING!

Risk of Injury or Damage

A safety feature of this product includes protection against overheating caused by excessive or extended periods of operation. Depending on the duration, this includes multiple or repeated adjustments or the use of multiple functions at one time.

- To ensure trouble free operation, ALWAYS allow a slight pause between multiple adjustments and avoid pressing more than one function button at a time. If thermal protection activation should occur, the product will not respond to pendant commands. Given this situation, release the pendant button and allow the product to sit for several minutes. This will allow the protection function time to reset and restore product function. Depending on severity of the initial overheating, this could take up to 30 minutes.
- After the thermal protection activation period is complete, the bed may be prone to sudden movement. Use caution when using the product after the protection function time has reset and the pendant function has been restored.

1. If any problems arise during the test, recheck all electrical connections and mechanical hook ups.
2. A six-function pendant is used for all bed operations.

Raising and Lowering



DANGER!

Risk of Death, Injury or Damage

Pendant malfunction may cause injury or damage.

- Unplug bed from electrical outlet and contact qualified technician or Invacare for repair if any malfunction is detected.

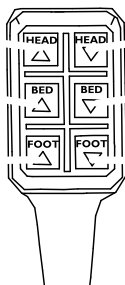

Entire Bed

1. To raise the entire bed, press the Bed Up button (A).
2. To lower entire bed, press the Bed Down button (B).

Head and Foot Sections

1. To raise the head section, press the Head Up button (C).
2. To lower the head section, press the Head Down button (D).
3. To raise the foot section, press the Foot Up button (E).
4. To lower the foot section, press the Foot Down button (F).

5.2 Emergency Crank



WARNING!

Risk of Injury or Damage

Due to a power outage or an electronic malfunction, an emergency crank is provided.

- DO NOT use the emergency crank to raise the bed. Personal injury or damage to the crank may occur.



WARNING!

Risk of Injury or Damage

To avoid injury or damage from moving parts



- Unplug the bed from the wall outlet before using the emergency crank.

Failure to remove the emergency crank may cause damage or personal injury.

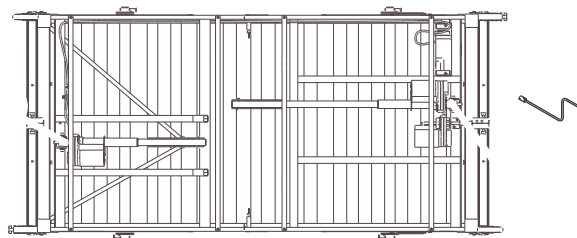
- The emergency crank MUST be removed before the bed is used.



Bottom of bed shown.

1. Under the bed, locate the exposed shaft end according to the function you want to perform.
2. Attach the emergency crank  to the motor shaft end of the head section  or the motor shaft end of the foot section .
3. Crank clockwise or counterclockwise to lower the bed.



Push in the emergency crank while turning clockwise or counterclockwise.

4. Remove the emergency crank.



WARNING!
Risk of Injury or Damage

The emergency crank will turn when motor is on and could cause personal injury or damage to the bed.

- ALWAYS remove the emergency crank before performing electronic functions.

5.3 Optional Bed Rails



WARNING!
Risk Of Injury Or Damage

To avoid injury or damage from misuse:

- DO NOT install the optional bed rails without reading and understanding the **Bed Rail Risk Notification Guide** that accompanies this manual and is included with each bed rail kit. The **Bed Rail Risk Notification Guide** can also be found at www.invacare.com.



DANGER!
Risk Of Death, Injury Or Damage

To avoid entrapment, damage, and/or personal injury:

- These bed rails are intended to prevent an individual from inadvertently rolling out of bed. Do not use for restraint purposes.
- Invacare recommends the use of two sets of half length bed rails: one set at the head end of the bed, and one set at the foot end of the bed where permitted.
- Use ONLY Invacare rails with Invacare products.
- DO NOT use the bed rails as push handles when moving the bed.



DANGER!
Risk Of Death, Injury Or Damage

To avoid entrapment, damage, and/or personal injury:

- The IVC Bariatric Bed Rails are shipped with two bed rail mounting brackets. These bed rail mounting brackets MUST be used when installing half length bed rails onto the Bariatric Bed.



WARNING!
Risk Of Injury Or Damage

To avoid personal injury or damage from misuse:

- Bed rail IS NOT an assist rail for getting into or out of bed.

**DANGER!****Risk Of Death, Injury Or Adverse Health Consequences**

Fall hazard exists due to incorrect installation of bed rails

- To avoid injury, ensure that the Invacare bed rails are installed correctly and securely attached to the bed while entering or exiting.

Fall hazard exists due to use of NON-Invacare bed rails. Non-Invacare bed rails are potentially incompatible with Invacare beds.

- To avoid injury, ensure that only Invacare bed rails are used with Invacare beds at all times.

Fall hazard exists due to use of NON-Invacare mattresses. Non-Invacare mattresses are potentially incompatible with Invacare beds.

- To avoid injury, ensure that only Invacare mattresses are used with Invacare beds at all times.

**DANGER!****Risk Of Death, Injury, Or Damage**

To avoid entrapment, product damage, and/or personal injury:

- When used with a manual/electric bed, the bed rails DO NOT fall under any weight limitations. Bed rails can be deformed or broken if excessive side pressure is exerted on the bed rails. These bed rails are used for the purpose of preventing an individual from inadvertently rolling out of bed. The bed rails are not intended nor may be used for restraint purposes. If an individual is capable of injuring himself/herself, a physician or a healthcare professional should be consulted for alternative means of safe restraint.
- After raising/lowering the head/foot end of the electric bed, check the distance between the bottom of the bed rail and the mattress. If there is excessive distance between the bottom of the bed rail and the mattress in which individuals may become entangled, adjust the height of the bed rail (if applicable), or provide alternative means of patient protection.
- DO NOT use the side rails as push handles for moving the electric bed.
- Replacement mattresses and bed side rails with dimensions different from the original equipment supplied or specified by the bed frame manufacturer are not interchangeable. Variations in bed side rail design, width and thickness or firmness of the mattress could cause/contribute to entrapment.

6 Maintenance

6.1 Service Life



WARNING!

Risk of Injury or Damage

Use of the product beyond this time period may cause product damage and injury.

- This product has an expected lifetime of seven (7) years when used in accordance with safety instructions, maintenance intervals and correct use stated in this manual.
- Perform all maintenance according to the recommended schedule in this manual.



The effective bed lifetime can vary according to the frequency and intensity of use.

6.2 Wear and Tear Items

Normal wear and tear items and components include, but are not limited to the items in the table:

Wear and Tear Items
Hand Pendants
Crank Handle
Casters—tread wear, brake levers
Drive Shafts

Invacare reserves the right to ask for any item back that has an alleged defect in workmanship. See the Warranty that shipped with the product for specific warranty information.

6.3 Washing Bed Ends



WARNING!

Risk of Injury or Damage

To avoid injury or damage from misuse:

- Read all guidelines, warnings and cautions before performing any repair/maintenance on the bed.
- All repair and maintenance on the bed should be performed by a qualified technician.



DANGER!

Risk of Injury or Death

To prevent a fall or fire:

- Inspect bed ends for leaking grease.
- Contact service provider if grease or other residue is detected.



CAUTION!

Risk of Damage

To protect flooring from damage or staining, perform the following:

- Ensure bed ends are completely drained and dry before placing on flooring.



DANGER!

Risk Of Death, Injury, or Damage

To avoid damage to electric controls:

- If a liquid is spilled in or around the electric bed, unplug the electric bed before cleaning.
- Clean up the spill and allow the electric bed or the area around the electric bed to dry thoroughly before using the electric controls again.



WARNING!

Risk Of Injury Or Damage

Grease may leak from the gearbox and cause injury or damage from falling or fire.

- Follow the maintenance instructions in this manual.
- Routinely inspect the gearbox for grease leakage.

If the gearbox is leaking grease:

- Stop use immediately.
- Keep the product away from sparks, flame, and open heat sources.
- Contact your dealer or Invacare for repair.





WARNING!

Risk Of Injury Or Damage

To avoid product damage or injury from malfunction:

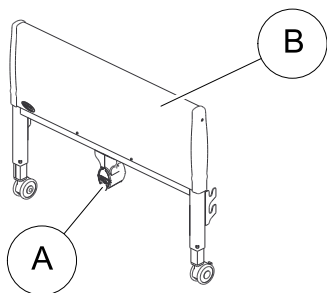
- Clean the product according to the instructions.
- The product may be damaged from multiple or excessive cleaning.



 **A** = gear box

1. Stand or prop each bed end **B** in an upright position on its legs.
2. Using a mild soap/detergent and soft bristle brush or sponge, scrub all exterior surfaces.
3. Using a hose and nozzle attachment, rinse bed ends thoroughly with plain cold or warm water.

 Do not exceed a water temperature of 110° F.

Use household tap pressure. **DO NOT** use pressure washers or steam cleaners.

DO NOT use solvents, bleach, alcohol, petroleum products, caustic agents or highly alkaline or acidic agents to clean the bed.

4. Tip bed end from side to side to allow any collected or trapped water to drain.

5. Thoroughly towel dry bed end and all components.
6. Repeat drying process until all components are dry.

 Ensure that the bed end is completely dry before storing.

6.4 Cleaning Head and Foot Sections



WARNING!

Risk Of Injury Or Damage

The electric motors, control box and pendant are **NOT** protected against the entrance of dust and liquids.

- **DO NOT** spray liquids into any electrical components.
- **DO NOT** wash head or foot section.
- **DO NOT** allow electrical components to get wet.

1. Unplug the power cord of electric beds before performing maintenance.
2. Wipe down the bed with disinfectant. Allow it to dry completely.

6.5 Maintenance and Cleaning Checklist

Invacare recommends the following maintenance/cleaning procedures be conducted initially, between users, or as needed. This form is provided as a guide to help with documentation.

Cleaning and Disinfecting Bed

- Unplug the power cord of electric beds before performing maintenance.
- Wipe down with disinfectant. Allow to dry completely.

Mechanical Inspection and Maintenance

- Inspect all bed components (i.e. rails, clevis pins, hitch pins, etc.) for damage or excessive wear and replace as necessary.
- Visually examine all welds for cracks.
- Inspect the head and foot spring sections for bending, warping or damage.
- Check drive shaft and drive shaft connections for bending, damage or excessive wear.
- Inspect pull tubes and mounting hardware for bending, damage or excessive wear.
- Inspect all bolts and rivets to ensure that they are securely tightened and functioning properly.
- Check casters to ensure they lock, if applicable, and roll properly.

In addition, dealers should inspect bed ends for proper operation:

1. Adjust bed ends to the lowest position.
2. Remove bed ends from head or foot spring.
3. Remove bed end caps and plastic cover.
4. Inspect cables and pulleys for wear.
5. Inspect Acme screws for lubrication. Apply a light lithium based grease if necessary.
6. Reinstall the plastic cover and end caps.

Electrical Inspection and Maintenance

- Inspect all electrical bed components for damage or excessive wear (i.e., cracked or broken housings, or worn components).
- Check pendant, power and motor cords for chafing, cuts or excessive wear.
- Make sure all plugs are fully attached and free of damage.
- Check all functions:
 1. Head raises and lowers properly.
 2. Foot raises and lowers properly.
 3. Bed ends raise and lower properly.

In addition dealers should inspect all electrical bed components:

- Chafing
- Nicks in the insulation
- Missing insulation
- Exposed internal wiring or conductors
- Signs of pinching or crushing
- Broken or deformed connectors



If these conditions are present, the bed **MUST** not be used until the damaged component/wiring is replaced. Modification or other forms or repair including electrical or similar tape **MUST NEVER** be used.

PASS/FAIL

- PASS:** Bed and all components have passed all of the preceding inspection criteria, and the bed is ready for placement into a client's home.
- FAIL:** Bed, or any component, has failed any of the preceding inspection criteria. Tag the bed or component with a complete description of the failure(s) and have the bed serviced.

7 Troubleshooting

7.1 Troubleshooting: Mechanical



USER/DEALER: Read this manual (including all general guidelines, warnings, and cautions) before servicing this product.

SYMPTOM	PROBABLE CAUSE	SOLUTION
Bed does not stay in place.	Locking casters not locked.	Lock casters. Refer to 4.5 Installing Casters, page 21.
Bed sections do not move.	Pull tube.	Ensure pull tubes are properly connected. Check pull tube(s) for binding. Call dealer for repairs.
Bed ends move in opposite directions (electrical or manual bed).	Drive shaft connected to wrong gear box shaft.	Call dealer. Reinstall drive shaft. Refer to 4.8 Assembling/Installing/Removing Drive Shaft, page 24.
Hi/Lo function does not work.	Drive shaft disconnected.	Call dealer. Reinstall drive shaft. Refer to 4.8 Assembling/Installing/Removing Drive Shaft, page 24.
Pressing function on pendant results in motion other than that intended.	Motor cable connections to junction box incorrect.	Call dealer. Verify connections.

7.2 Troubleshooting: Electrical

SYMPTOM	PROBABLE CAUSE	SOLUTION
Bed section does not move	End of stroke reached	Operate opposite button.
Full Electric Bed: Hi/Lo function does not work	Bed not plugged in	Ensure power cord is plugged into power source.
	Pendant not functioning	Ensure Pendant correctly connected to junction box. Ensure Pendant cable is not entangled/pinched.
	Cables	Ensure motor cable(s) correctly connected. Ensure cables are not entangled/pinched. Call the dealer for repair/replacement of cables and/or motors.
	Household fuse or breaker blown	Check household fuse/breaker box.
	Motors are not functioning	Call dealer.
	Hi/Lo Motor	Ensure Hi/Lo motor cable is correctly connected. Ensure cables are not entangled or pinched. Ensure drive shaft is correctly installed.
Bed Spring does not stop moving	Pendant	Check for depressed/stuck buttons. If button is stuck, call dealer for repair.
Bed Hi/Lo movement does not stop	Hi/Lo Motor	Check cables. If damaged, call dealer.

8 Warranty

8.1 Limited Warranty



THE WARRANTY BELOW HAS BEEN DRAFTED TO COMPLY WITH FEDERAL LAW APPLICABLE TO PRODUCTS MANUFACTURED AFTER JULY 4, 1975.

This warranty is extended only to the original purchaser who purchases this product when new and unused from Invacare or a dealer. This warranty is not extended to any other person or entity and is not transferable or assignable to any subsequent purchaser or owner. Coverage under this warranty will end upon any such subsequent sale or other transfer of title to any other person.

This warranty gives you specific legal rights and you may also have other legal rights which vary from state to state.

Invacare warrants the mechanical and electrical components of this product when purchased new and unused to be free from defects in materials and workmanship for a period of one year from date of purchase from Invacare or a dealer, with a copy of the seller's invoice required for coverage under this warranty. Invacare warrants all welds of this product when purchased new and unused to be free from defects in materials and workmanship for a period of five years from date of purchase from Invacare or a dealer, with a copy of the seller's invoice required for coverage under this warranty. If within such warranty periods any such product shall be proven to be defective, such product shall be repaired or replaced, at Invacare's option. This warranty does not include any labor or shipping charges incurred in replacement part installation or repair of any such product. Invacare's sole obligation and your exclusive remedy under this warranty shall be limited to such repair and/or replacement.

For warranty service, please contact the dealer from whom you purchased your Invacare product. In the event you do not receive satisfactory warranty service, please write directly to Invacare at the address on the back cover, provide dealer's name, address, and the date of purchase, indicate nature of the defect and, if the product is serialized, indicate the serial number. Do not return products to our factory without our prior consent.

LIMITATIONS AND EXCLUSIONS: THE FOREGOING WARRANTY SHALL NOT APPLY TO SERIAL NUMBERED PRODUCTS IF THE SERIAL NUMBER HAS BEEN REMOVED OR DEFACED, PRODUCTS SUBJECT TO NEGLIGENCE, ACCIDENT, IMPROPER OPERATION, MAINTENANCE OR STORAGE, PRODUCTS MODIFIED WITHOUT INVACARE'S EXPRESS WRITTEN CONSENT (INCLUDING, BUT NOT LIMITED TO, MODIFICATION THROUGH THE USE OF UNAUTHORIZED PARTS OR ATTACHMENTS; PRODUCTS DAMAGED BY REASON OF REPAIRS MADE TO ANY COMPONENT WITHOUT THE SPECIFIC CONSENT OF INVACARE, OR TO A PRODUCT DAMAGED BY CIRCUMSTANCES BEYOND INVACARE'S CONTROL, AND SUCH EVALUATION WILL BE SOLELY DETERMINED BY INVACARE. THE WARRANTY SHALL NOT APPLY TO NORMAL WEAR AND TEAR OR FAILURE TO ADHERE TO THE PRODUCT INSTRUCTIONS.

THE FOREGOING EXPRESS WARRANTY IS EXCLUSIVE AND IN LIEU OF ANY OTHER WARRANTIES WHATSOEVER, WHETHER EXPRESS OR IMPLIED, INCLUDING THE IMPLIED WARRANTIES OF MERCHANTABILITY AND FITNESS FOR A PARTICULAR PURPOSE, AND THE SOLE REMEDY FOR VIOLATIONS OF ANY WARRANTY WHATSOEVER, SHALL BE LIMITED TO REPAIR OR REPLACEMENT OF THE DEFECTIVE PRODUCT PURSUANT TO THE TERMS CONTAINED HEREIN. THE APPLICATION OF ANY IMPLIED WARRANTY WHATSOEVER SHALL NOT EXTEND BEYOND THE DURATION OF THE EXPRESS WARRANTY PROVIDED HEREIN. INVACARE SHALL NOT BE LIABLE FOR ANY CONSEQUENTIAL OR INCIDENTAL DAMAGES WHATSOEVER.

SOME STATES DO NOT ALLOW THE EXCLUSION OR LIMITATION OF INCIDENTAL OR CONSEQUENTIAL DAMAGE, OR LIMITATION OF HOW LONG AN IMPLIED WARRANTY LASTS, SO THE ABOVE EXCLUSION AND LIMITATION MAY NOT BE APPLICABLE.

THIS WARRANTY SHALL BE EXTENDED TO COMPLY WITH STATE/PROVINCIAL LAWS AND REQUIREMENTS.

Notes

1123842-J-01 2016-10-19



Making Life's Experiences Possible®



Yes, you can.®