

Mark For: _____

Submitting for: Quote Order

Date: _____

PO#: _____

Dealer Acct #: _____

Dealer: _____

Dealer Contact: _____

Dealer Address: _____

Dealer City: _____ ST: _____ ZIP: _____

Dealer Phone: () _____ Fax: () _____

Confirmation Email: _____

Confirm Via: Fax Email

ADDITIONAL SHIPPING INFORMATION

Ship To: _____

Attention: _____

Address: _____

Address: _____

Ship To City: _____ ST: _____ ZIP: _____

Ship To Phone: () _____ Fax: () _____



The **HCPCS CODES** provided are based on code verification through PDAC or our interpretation of the code definitions.

The use of **HCPCS CODES** does not ensure coverage or payment. For coverage information, verify the appropriate payer's coverage policy.

Note: For cover selection, **L** = Lycra and **V** = Dartex Reversed (Example: AXYS-HUFALL or AXYS-HUFAL V)

Head Positioning - Use HCPCS Code E0955

Whitmyer headrests come unassembled. Please add item WHITASSY001 if the dealer would like parts assembled. This is a no charge option.

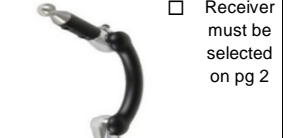
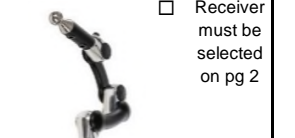
	<input type="checkbox"/> Receiver must be selected on pg 2		<input type="checkbox"/> Receiver must be selected on pg 2		<input type="checkbox"/> Receiver must be selected on pg 2		<input type="checkbox"/> Receiver must be selected on pg 2
---	--	---	--	--	--	---	--

PAD	AXYS	ONYX	LINX	LINX²
------------	-------------	-------------	-------------	-------------------------



CONTOUR CRADLE	Large	<input type="checkbox"/> AXYS-CCS4L \$200	<input type="checkbox"/> ONYX-CCS4L \$200	<input type="checkbox"/> LINX-CCS4L \$155	<input type="checkbox"/> LINX2-CCS4L \$190
	Medium	<input type="checkbox"/> AXYS-CCS4V \$200	<input type="checkbox"/> ONYX-CCS4V \$200	<input type="checkbox"/> LINX-CCS4V \$155	<input type="checkbox"/> LINX2-CCS4V \$190
		<input type="checkbox"/> AXYS-CCS3L \$190	<input type="checkbox"/> ONYX-CCS3L \$190	<input type="checkbox"/> LINX-CCS3L \$145	<input type="checkbox"/> LINX2-CCS3L \$180
	Small	<input type="checkbox"/> AXYS-CCS3V \$190	<input type="checkbox"/> ONYX-CCS3V \$190	<input type="checkbox"/> LINX-CCS3V \$145	<input type="checkbox"/> LINX2-CCS3V \$180
		<input type="checkbox"/> AXYS-CCS2L \$180	<input type="checkbox"/> ONYX-CCS2L \$180	<input type="checkbox"/> LINX-CCS2L \$135	<input type="checkbox"/> LINX2-CCS2L \$170
	<input type="checkbox"/> AXYS-CCS2V \$180	<input type="checkbox"/> ONYX-CCS2V \$180	<input type="checkbox"/> LINX-CCS2V \$135	<input type="checkbox"/> LINX2-CCS2V \$170	

C-PLUSH	Large	<input type="checkbox"/> AXYS-CCP4L \$200	<input type="checkbox"/> ONYX-CCP4L \$200	<input type="checkbox"/> LINX-CCP4L \$155	<input type="checkbox"/> LINX2-CCP4L \$190
	Medium	<input type="checkbox"/> AXYS-CCP4V \$200	<input type="checkbox"/> ONYX-CCP4V \$200	<input type="checkbox"/> LINX-CCP4V \$155	<input type="checkbox"/> LINX2-CCP4V \$190
		<input type="checkbox"/> AXYS-CCP3L \$190	<input type="checkbox"/> ONYX-CCP3L \$190	<input type="checkbox"/> LINX-CCP3L \$145	<input type="checkbox"/> LINX2-CCP3L \$180
	Small	<input type="checkbox"/> AXYS-CCP3V \$190	<input type="checkbox"/> ONYX-CCP3V \$190	<input type="checkbox"/> LINX-CCP3V \$145	<input type="checkbox"/> LINX2-CCP3V \$180
		<input type="checkbox"/> AXYS-CCP2L \$180	<input type="checkbox"/> ONYX-CCP2L \$180	<input type="checkbox"/> LINX-CCP2L \$135	<input type="checkbox"/> LINX2-CCP2L \$170
	<input type="checkbox"/> AXYS-CCP2V \$180	<input type="checkbox"/> ONYX-CCP2V \$180	<input type="checkbox"/> LINX-CCP2V \$135	<input type="checkbox"/> LINX2-CCP2V \$170	

CONTOUR CRADLE INFANT	<input type="checkbox"/> AXYS-CCS1 \$180	<input type="checkbox"/> ONYX-CCS1 \$180	N/A
------------------------------	--	--	------------

Head Positioning - Use HCPCS Code E0955

Whitmyer headrests come unassembled. Please add item WHITASSY001 if the dealer would like parts assembled. This is a no charge option.

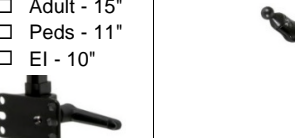
	<input type="checkbox"/> Receiver must be selected on pg 2		<input type="checkbox"/> Adult - 15" <input type="checkbox"/> Peds - 11" <input type="checkbox"/> EI - 10"		<input type="checkbox"/> Adult - 15" <input type="checkbox"/> Peds - 11" <input type="checkbox"/> EI - 10"
---	--	---	--	--	--





PAD	PRO	COBRA	COBRA-FB
------------	------------	--------------	-----------------

CONTOUR CRADLE	Large	<input type="checkbox"/> PRO-CCS4L \$230	<input type="checkbox"/> COBRA-CCS4L \$430	<input type="checkbox"/> FB-COBRA-CCS4L \$530
	Medium	<input type="checkbox"/> PRO-CCS4V \$230	<input type="checkbox"/> COBRA-CCS4V \$430	<input type="checkbox"/> FB-COBRA-CCS4V \$530
		<input type="checkbox"/> PRO-CCS3L \$230	<input type="checkbox"/> COBRA-CCS3L \$430	<input type="checkbox"/> FB-COBRA-CCS3L \$530
	Small	<input type="checkbox"/> PRO-CCS3V \$230	<input type="checkbox"/> COBRA-CCS3V \$430	<input type="checkbox"/> FB-COBRA-CCS3V \$530
		<input type="checkbox"/> PRO-CCS2L \$230	<input type="checkbox"/> COBRA-CCS2L \$430	<input type="checkbox"/> FB-COBRA-CCS2L \$530
	<input type="checkbox"/> PRO-CCS2V \$230	<input type="checkbox"/> COBRA-CCS2V \$430	<input type="checkbox"/> FB-COBRA-CCS2V \$530	

C-PLUSH	Large	<input type="checkbox"/> PRO-CCP4L \$230	<input type="checkbox"/> COBRA-CCP4L \$430	<input type="checkbox"/> FB-COBRA-CCP4L \$530
	Medium	<input type="checkbox"/> PRO-CCP4V \$230	<input type="checkbox"/> COBRA-CCP4V \$430	<input type="checkbox"/> FB-COBRA-CCP4V \$530
		<input type="checkbox"/> PRO-CCP3L \$230	<input type="checkbox"/> COBRA-CCP3L \$430	<input type="checkbox"/> FB-COBRA-CCP3L \$530
	Small	<input type="checkbox"/> PRO-CCP3V \$230	<input type="checkbox"/> COBRA-CCP3V \$430	<input type="checkbox"/> FB-COBRA-CCP3V \$530
		<input type="checkbox"/> PRO-CCP2L \$230	<input type="checkbox"/> COBRA-CCP2L \$430	<input type="checkbox"/> FB-COBRA-CCP2L \$530
	<input type="checkbox"/> PRO-CCP2V \$230	<input type="checkbox"/> COBRA-CCP2V \$430	<input type="checkbox"/> FB-COBRA-CCP2V \$530	

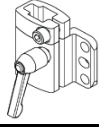
Mounting Brackets - Use HCPCS Code E1028

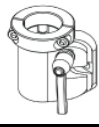
Head Support System Mounting Brackets must be ordered separately, except for COBRA

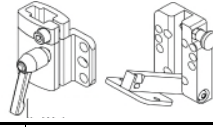
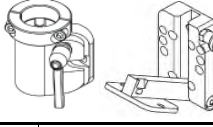
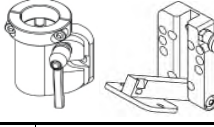
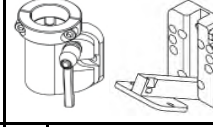
	AXYS	ONYX	LINX & LINX ²	PRO	COBRA mounting system includes detachable mounting bracket
REMOVABLE MOUNTING BRACKET (PART SOLD SEPARATELY FROM POST & PAD)					
Detachable	<input type="checkbox"/> M2500 \$105	<input type="checkbox"/> M2100-WB \$85	<input type="checkbox"/> M2300 \$165	<input type="checkbox"/> M2200-WB \$185	
REMOVABLE & SWING-AWAY MNT BRACKET (PART SOLD SEPARATELY FROM POST & PAD)					
Swing-Away	<input type="checkbox"/> M5500 \$200	<input type="checkbox"/> M5100 \$185	<input type="checkbox"/> M5300 \$265	<input type="checkbox"/> M5200 \$285	

Lateral Facial Supports

Note: Cover Selection - Add L = Lycra or V = Dartex Reversed (Example: LFC-PLL)

	SPOT	STANDARD	LONG	OVAL	LARGE-C	MED-C	SMALL-C	FSO-B
Unilateral	<input type="checkbox"/> LFC10-CSL \$220 LM115 \$80	<input type="checkbox"/> LFC15-CSL \$220 LM115 \$80	<input type="checkbox"/> LFC20-CSL \$220 LM115 \$80	<input type="checkbox"/> LFC25-CSL \$220 LM115 \$80	<input type="checkbox"/> LFC30-CSL \$220 LM115 \$80	<input type="checkbox"/> LFC35-CSL \$220 LM115 \$80	<input type="checkbox"/> LFC40-CSL \$220 LM115 \$80	<input type="checkbox"/> LFC80-CS \$255 LM115 \$80
Bilateral	<input type="checkbox"/> LFC10-CS2L \$410 LM115 \$80 LM115 \$80	<input type="checkbox"/> LFC15-CS2L \$410 LM115 \$80 LM115 \$80	<input type="checkbox"/> LFC20-CS2L \$410 LM115 \$80 LM115 \$80	<input type="checkbox"/> LFC25-CS2L \$410 LM115 \$80 LM115 \$80	<input type="checkbox"/> LFC30-CS2L \$410 LM115 \$80 LM115 \$80	<input type="checkbox"/> LFC35-CS2L \$410 LM115 \$80 LM115 \$80	<input type="checkbox"/> LFC40-CS2L \$410 LM115 \$80 LM115 \$80	<input type="checkbox"/> LFC80-CS2 \$469 LM115 \$80 LM115 \$80
Pad Only*	<input type="checkbox"/> PL10L \$70 <input type="checkbox"/> PL10V \$70	<input type="checkbox"/> PL15L \$100 <input type="checkbox"/> PL15V \$100	<input type="checkbox"/> PL20L \$100 <input type="checkbox"/> PL20V \$100	<input type="checkbox"/> P600L \$100 <input type="checkbox"/> P600V \$100	<input type="checkbox"/> PL30L \$100 <input type="checkbox"/> PL30V \$100	<input type="checkbox"/> PL35L \$100 <input type="checkbox"/> PL35V \$100	<input type="checkbox"/> PL40L \$90 <input type="checkbox"/> PL40V \$90	N/A

LATERAL FACIAL SUPPORT PARTS



**Note: If ordering an additional Lateral Facial Support, select both a Lateral Facial Support Pad Only from above and an Infinity Mount from below as well*

✓	Option #	Definition	Price
<input type="checkbox"/>	242161	Infinity Dual Mount Assembly*	\$195
<input type="checkbox"/>	LM1010	Lateral Facial Support*	\$125

ANTERIOR HEAD SUPPORT

	DYNAMIC FOREHEAD STRAP	DFS ²	STRAP CAP	STATIC FOREHEAD STRAP
ADULT	<input type="checkbox"/> DFS10 \$289	<input type="checkbox"/> DFSQ10 \$349	<input type="checkbox"/> CAP10 (black) \$400	<input type="checkbox"/> HU10 \$315
PEDS	<input type="checkbox"/> DFS30 \$289	<input type="checkbox"/> DFSQ30 \$349	<input type="checkbox"/> CAP30-R (red) \$400	
			<input type="checkbox"/> CAP30-B (blue) \$400	

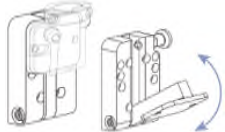
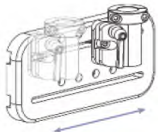
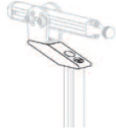



CUSTOM MOUNTING OPTIONS

				
FLEX INTERFACE BRACKET	UNIVERSAL SWING-AWAY MOUNT	SLIDE MOUNT	PRO OFF-SET MOUNTING SYSTEM	ONYX REARWARD OFF-SET VERTICAL ROD
<input type="checkbox"/> M9450 (hard) \$185 <input type="checkbox"/> M8451 (soft) \$185	<input type="checkbox"/> M5000 \$100	<input type="checkbox"/> M7010 \$95	<input type="checkbox"/> PRC7070 \$163	<input type="checkbox"/> OX6030 \$60

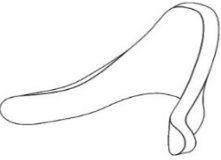

TOOLS

<input checked="" type="checkbox"/>	Option #	Definition	Price
<input type="checkbox"/>	BOLT LUBE	Bolt Lube	\$0
<input type="checkbox"/>	T2500	Tool Kit	\$3.33

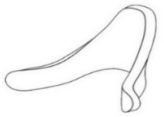

Pad Styles

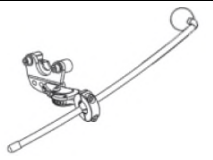
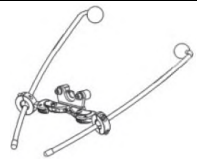
C-PLUSH			
	Large CCP4 7"w X 5"h	Medium CCP3 6"w X 4-1/2"h	Small CCP2 5"w X 4"h
CONTOUR CRADLE			
	Large CCS4 13"w X 7-1/2"h	Medium CCS3 10"w X 6-1/4"h	Small CCS2 8-1/2"w X 5-1/2"h

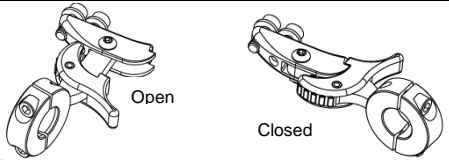
Lateral Facial Supports

MOUNTING HARDWARE				
	Unilateral	Bilateral	Infinity Mount	Swing-Away Mount LM115

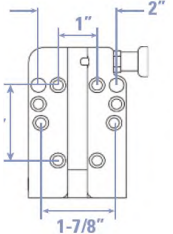
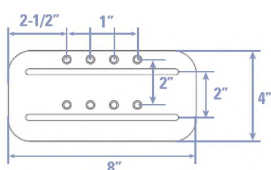
CUSTOM MOUNTS

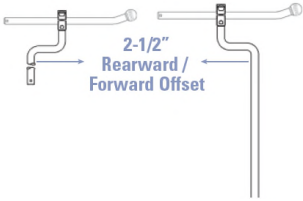
			
UNIVERSAL SWING-AWAY MOUNT	SLIDE MOUNT	PRO OFF-SET MOUNTING SYSTEM	ONYX REARWARD OFF-SET VERTICAL ROD

