

Mark For: _____

Submitting for: Quote Order

Date: _____

PO#: _____

Dealer Acct #: _____

Dealer: _____

Dealer Contact: _____

Dealer Address: _____

Dealer City: _____ ST: _____ ZIP: _____

Dealer Phone: () _____ Fax: () _____

Confirmation Email: _____

Confirm Via: Fax Email

ADDITIONAL SHIPPING INFORMATION

Ship To: _____

Attention: _____

Address: _____

Address: _____

Ship To City: _____ ST: _____ ZIP: _____

Ship To Phone: () _____ Fax: () _____

The **HCPCS CODES** provided are based on code verification through PDAC or our interpretation of the code definitions.

The use of **HCPCS CODES** does not ensure coverage or payment. For coverage information, verify the appropriate payer's coverage policy.

Note: For cover selection, **L** = Lycra and **V** = Dartex Reversed

Head Positioning - Use HCPCS Code E0955

Whitmyer headrests come unassembled. Please add item WHITASSY001 if the dealer would like parts assembled. This is a no charge option.





PAD	AXYS	ONYX	LINX	LINX ²
-----	------	------	------	-------------------

SINGLE SUB-OCCIPITAL	10" Pad Lrg OCC	<input type="checkbox"/> AXYS-SS10L \$370	<input type="checkbox"/> ONYX-SS10L \$370	<input type="checkbox"/> LINX-SS10L \$395	<input type="checkbox"/> LINX2-SS10L \$430
	6" Pad Lrg OCC	<input type="checkbox"/> AXYS-SS10V \$370	<input type="checkbox"/> ONYX-SS10V \$370	<input type="checkbox"/> LINX-SS10V \$395	<input type="checkbox"/> LINX2-SS10V \$430
	6" Pad Sml OCC	<input type="checkbox"/> AXYS-SS8L \$345	<input type="checkbox"/> ONYX-SS8L \$345	<input type="checkbox"/> LINX-SS8L \$375	<input type="checkbox"/> LINX2-SS8L \$410
	6" Pad Sml OCC	<input type="checkbox"/> AXYS-SS8V \$345	<input type="checkbox"/> ONYX-SS8V \$345	<input type="checkbox"/> LINX-SS8V \$375	<input type="checkbox"/> LINX2-SS8V \$410
	5" Pad Sml OCC	<input type="checkbox"/> AXYS-SS4L \$315	<input type="checkbox"/> ONYX-SS4L \$315	<input type="checkbox"/> LINX-SS4L \$345	<input type="checkbox"/> LINX2-SS4L \$380
ADULT DUAL SUB-OCCIPITAL	8" Pad Size 1 OCC	<input type="checkbox"/> AXYS-SS4V \$315	<input type="checkbox"/> ONYX-SS4V \$315	<input type="checkbox"/> LINX-SS4V \$345	<input type="checkbox"/> LINX2-SS4V \$380
	10" Pad Size 1 OCC	<input type="checkbox"/> AXYS-SS3L \$315	<input type="checkbox"/> ONYX-SS3L \$315	<input type="checkbox"/> LINX-SS3L \$345	<input type="checkbox"/> LINX2-SS3L \$380
	6" Pad Size 2 OCC	<input type="checkbox"/> AXYS-SS3V \$315	<input type="checkbox"/> ONYX-SS3V \$315	<input type="checkbox"/> LINX-SS3V \$345	<input type="checkbox"/> LINX2-SS3V \$380
	6" Pad Size 1 OCC	<input type="checkbox"/> AXYS-8L \$435	<input type="checkbox"/> ONYX-8L \$475	<input type="checkbox"/> LINX-8L \$450	<input type="checkbox"/> LINX2-8L \$485
	6" Pad Size 1 OCC	<input type="checkbox"/> AXYS-8V \$435	<input type="checkbox"/> ONYX-8V \$475	<input type="checkbox"/> LINX-8V \$450	<input type="checkbox"/> LINX2-8V \$485
PEDIATRIC DUAL SUB-OCCIPITAL	8" Pad Size 3 OCC	<input type="checkbox"/> AXYS-5L \$495	<input type="checkbox"/> ONYX-5L \$495	<input type="checkbox"/> LINX-5L \$470	<input type="checkbox"/> LINX2-5L \$505
	5" Pad Size 4 OCC	<input type="checkbox"/> AXYS-5V \$495	<input type="checkbox"/> ONYX-5V \$495	<input type="checkbox"/> LINX-5V \$470	<input type="checkbox"/> LINX2-5V \$505
	6" Pad Size 3 OCC	<input type="checkbox"/> AXYS-2L \$430	<input type="checkbox"/> ONYX-2L \$430	<input type="checkbox"/> LINX-2L \$415	<input type="checkbox"/> LINX2-2L \$450
	6" Pad Size 3 OCC	<input type="checkbox"/> AXYS-2V \$430	<input type="checkbox"/> ONYX-2V \$430	<input type="checkbox"/> LINX-2V \$415	<input type="checkbox"/> LINX2-2V \$450
	5" Pad Size 3 OCC	<input type="checkbox"/> AXYS-1L \$430	<input type="checkbox"/> ONYX-1L \$430	<input type="checkbox"/> LINX-1L \$415	<input type="checkbox"/> LINX2-1L \$450
CUDDLES INFANT	8" Pad Size 3 OCC	<input type="checkbox"/> AXYS-1V \$430	<input type="checkbox"/> ONYX-1V \$430	<input type="checkbox"/> LINX-1V \$415	<input type="checkbox"/> LINX2-1V \$450
	5" Pad Size 3 OCC	<input type="checkbox"/> AXYS-7L \$435	<input type="checkbox"/> ONYX-7L \$430	<input type="checkbox"/> LINX-7L \$450	<input type="checkbox"/> LINX2-7L \$485
		<input type="checkbox"/> AXYS-7V \$435	<input type="checkbox"/> ONYX-7V \$430	<input type="checkbox"/> LINX-7V \$450	<input type="checkbox"/> LINX2-7V \$485
		<input type="checkbox"/> AXYS-6L \$430	<input type="checkbox"/> ONYX-6L \$430	<input type="checkbox"/> LINX-6L \$415	<input type="checkbox"/> LINX2-6L \$450
		<input type="checkbox"/> AXYS-6V \$430	<input type="checkbox"/> ONYX-6V \$430	<input type="checkbox"/> LINX-6V \$415	<input type="checkbox"/> LINX2-6V \$450
		<input type="checkbox"/> AXYS-4L \$430	<input type="checkbox"/> ONYX-4L \$430	<input type="checkbox"/> LINX-4L \$415	<input type="checkbox"/> LINX2-4L \$450
		<input type="checkbox"/> AXYS-4V \$430	<input type="checkbox"/> ONYX-4V \$430	<input type="checkbox"/> LINX-4V \$415	<input type="checkbox"/> LINX2-4V \$450
		<input type="checkbox"/> AXYS-3L \$430	<input type="checkbox"/> ONYX-3L \$430	<input type="checkbox"/> LINX-3L \$415	<input type="checkbox"/> LINX2-3L \$450
		<input type="checkbox"/> AXYS-3V \$430	<input type="checkbox"/> ONYX-3V \$430	<input type="checkbox"/> LINX-3V \$415	<input type="checkbox"/> LINX2-3V \$450
		<input type="checkbox"/> AXYS-INFT \$330	<input type="checkbox"/> ONYX-INFTL \$330	N/A	

Head Positioning - Use HCPCS Code E0955

Whitmyer headrests come unassembled. Please add item WHITASSY001 if the dealer would like parts assembled. This is a no charge option.

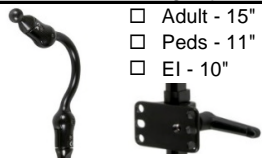
		<input type="checkbox"/> Receiver must be selected at bottom of page		<input type="checkbox"/> Adult - 15" <input type="checkbox"/> Peds - 11" <input type="checkbox"/> EI - 10"		<input type="checkbox"/> Adult - 15" <input type="checkbox"/> Peds - 11" <input type="checkbox"/> EI - 10"
PAD	PRO		COBRA		COBRA-FB	





SINGLE SUB-OCCIPITAL	10" Pad Lrg OCC	<input type="checkbox"/> PRO-SS10L	\$430	<input type="checkbox"/> COBRA-SS10L	\$630	<input type="checkbox"/> FB-COBRA-SS10L	\$730
		<input type="checkbox"/> PRO-SS10V	\$430	<input type="checkbox"/> COBRA-SS10V	\$630	<input type="checkbox"/> FB-COBRA-SS10V	\$730
	6" Pad Lrg OCC	<input type="checkbox"/> PRO-SS8L	\$420	<input type="checkbox"/> COBRA-SS8L	\$620	<input type="checkbox"/> FB-COBRA-SS8L	\$720
		<input type="checkbox"/> PRO-SS8V	\$420	<input type="checkbox"/> COBRA-SS8V	\$620	<input type="checkbox"/> FB-COBRA-SS8V	\$720
	6" Pad Sml OCC	<input type="checkbox"/> PRO-SS4L	\$360	<input type="checkbox"/> COBRA-SS4L	\$560	<input type="checkbox"/> FB-COBRA-SS4L	\$660
	<input type="checkbox"/> PRO-SS4V	\$360	<input type="checkbox"/> COBRA-SS4V	\$560	<input type="checkbox"/> FB-COBRA-SS4V	\$660	
	<input type="checkbox"/> PRO-SS3L	\$360	<input type="checkbox"/> COBRA-SS3L	\$560	<input type="checkbox"/> FB-COBRA-SS3L	\$660	
	<input type="checkbox"/> PRO-SS3V	\$360	<input type="checkbox"/> COBRA-SS3V	\$560	<input type="checkbox"/> FB-COBRA-SS3V	\$660	

ADULT DUAL SUB-OCCIPITAL	8" Pad Size 1 OCC	<input type="checkbox"/> PRO-8L	\$515	<input type="checkbox"/> COBRA-8L	\$715	<input type="checkbox"/> FB-COBRA-8L	\$815
		<input type="checkbox"/> PRO-8V	\$515	<input type="checkbox"/> COBRA-8V	\$715	<input type="checkbox"/> FB-COBRA-8V	\$815
	10" Pad Size 1 OCC	<input type="checkbox"/> PRO-5L	\$515	<input type="checkbox"/> COBRA-5L	\$715	<input type="checkbox"/> FB-COBRA-5L	\$815
		<input type="checkbox"/> PRO-5V	\$515	<input type="checkbox"/> COBRA-5V	\$715	<input type="checkbox"/> FB-COBRA-5V	\$815
	6" Pad Size 2 OCC	<input type="checkbox"/> PRO-2L	\$470	<input type="checkbox"/> COBRA-2L	\$670	<input type="checkbox"/> FB-COBRA-2L	\$770
	<input type="checkbox"/> PRO-2V	\$470	<input type="checkbox"/> COBRA-2V	\$670	<input type="checkbox"/> FB-COBRA-2V	\$770	
	<input type="checkbox"/> PRO-1L	\$470	<input type="checkbox"/> COBRA-1L	\$670	<input type="checkbox"/> FB-COBRA-1L	\$770	
	<input type="checkbox"/> PRO-1V	\$470	<input type="checkbox"/> COBRA-1V	\$670	<input type="checkbox"/> FB-COBRA-1V	\$770	

PEDIATRIC DUAL SUB-OCCIPITAL	8" Pad Size 3 OCC	<input type="checkbox"/> PRO-7L	\$510	<input type="checkbox"/> COBRA-7L	\$710	<input type="checkbox"/> FB-COBRA-7L	\$810
		<input type="checkbox"/> PRO-7V	\$510	<input type="checkbox"/> COBRA-7V	\$710	<input type="checkbox"/> FB-COBRA-7V	\$810
	5" Pad Size 4 OCC	<input type="checkbox"/> PRO-6L	\$460	<input type="checkbox"/> COBRA-6L	\$660	<input type="checkbox"/> FB-COBRA-6L	\$760
		<input type="checkbox"/> PRO-6V	\$460	<input type="checkbox"/> COBRA-6V	\$660	<input type="checkbox"/> FB-COBRA-6V	\$760
	6" Pad Size 3 OCC	<input type="checkbox"/> PRO-4L	\$460	<input type="checkbox"/> COBRA-4L	\$660	<input type="checkbox"/> FB-COBRA-4L	\$760
	<input type="checkbox"/> PRO-4V	\$460	<input type="checkbox"/> COBRA-4V	\$660	<input type="checkbox"/> FB-COBRA-4V	\$760	
	<input type="checkbox"/> PRO-3L	\$460	<input type="checkbox"/> COBRA-3L	\$660	<input type="checkbox"/> FB-COBRA-3L	\$760	
	<input type="checkbox"/> PRO-3V	\$460	<input type="checkbox"/> COBRA-3V	\$660	<input type="checkbox"/> FB-COBRA-3V	\$760	

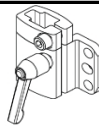
Mounting Brackets - Use HCPCS Code E1028

Head Support System Mounting Brackets must be ordered separately, except for COBRA

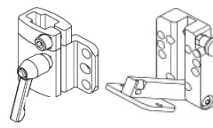
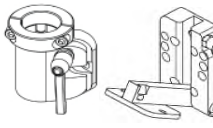
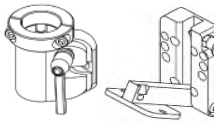
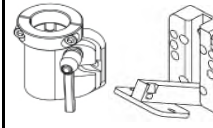
	AXYS	ONYX	LINX & LINX²	PRO	COBRA mounting system includes detachable mounting bracket
REMOVABLE MOUNTING BRACKET <small>(PART SOLD SEPARATELY FROM POST & PAD)</small>					
Detachable	<input type="checkbox"/> M2500 \$105	<input type="checkbox"/> M2100-WB \$85	<input type="checkbox"/> M2300 \$165	<input type="checkbox"/> M2200-WB \$185	
REMOVABLE & SWING-AWAY MNT BRACKET <small>(PART SOLD SEPARATELY FROM POST & PAD)</small>					
Swing-Away	<input type="checkbox"/> M5500 \$200	<input type="checkbox"/> M5100 \$185	<input type="checkbox"/> M5300 \$265	<input type="checkbox"/> M5200 \$285	

Lateral Facial Supports

Note: Cover Selection - Add L = Lycra or V = Dartex Reversed (Example: LFC-PL L)

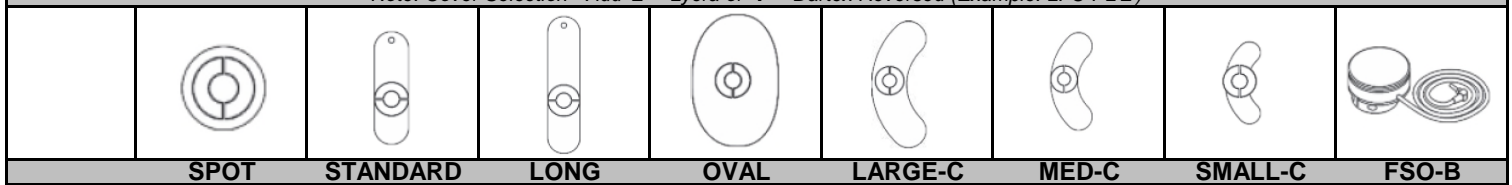

	SPOT	STANDARD	LONG	OVAL	LARGE-C	MED-C	SMALL-C	FSO-B
Unilateral	<input type="checkbox"/> LFC10L \$185 LM115 \$80	<input type="checkbox"/> LFC15L \$185 LM115 \$80	<input type="checkbox"/> LFC20L \$185 LM115 \$80	<input type="checkbox"/> LFC25L \$185 LM115 \$80	<input type="checkbox"/> LFC30L \$185 LM115 \$80	<input type="checkbox"/> LFC35L \$185 LM115 \$80	<input type="checkbox"/> LFC40L \$185 LM115 \$80	<input type="checkbox"/> LFC80 \$215 LM115 \$80
	<input type="checkbox"/> LFC10V \$185 LM115 \$80	<input type="checkbox"/> LFC15V \$185 LM115 \$80	<input type="checkbox"/> LFC20V \$185 LM115 \$80	<input type="checkbox"/> LFC25V \$185 LM115 \$80	<input type="checkbox"/> LFC30V \$185 LM115 \$80	<input type="checkbox"/> LFC35V \$185 LM115 \$80	<input type="checkbox"/> LFC40V \$185 LM115 \$80	

Bilateral	<input type="checkbox"/> LFC10L \$185 LM115 \$80	<input type="checkbox"/> LFC15L \$185 LM115 \$80	<input type="checkbox"/> LFC20L \$185 LM115 \$80	<input type="checkbox"/> LFC25L \$185 LM115 \$80	<input type="checkbox"/> LFC30L \$185 LM115 \$80	<input type="checkbox"/> LFC35L \$185 LM115 \$80	<input type="checkbox"/> LFC40L \$185 LM115 \$80	<input type="checkbox"/> LFC80 \$215 LFC80 \$215 LM115 \$80 LM115 \$80
	<input type="checkbox"/> LFC10V \$185 LM115 \$80	<input type="checkbox"/> LFC15V \$185 LM115 \$80	<input type="checkbox"/> LFC20V \$185 LM115 \$80	<input type="checkbox"/> LFC25V \$185 LM115 \$80	<input type="checkbox"/> LFC30V \$185 LM115 \$80	<input type="checkbox"/> LFC35V \$185 LM115 \$80	<input type="checkbox"/> LFC40V \$185 LM115 \$80	

Pad Only*	<input type="checkbox"/> PL10L \$70	<input type="checkbox"/> PL15L \$100	<input type="checkbox"/> PL20L \$100	<input type="checkbox"/> P600L \$100	<input type="checkbox"/> PL30L \$100	<input type="checkbox"/> PL35L \$100	<input type="checkbox"/> PL40L \$90	N/A
	<input type="checkbox"/> PL10V \$70	<input type="checkbox"/> PL15V \$100	<input type="checkbox"/> PL20V \$100	<input type="checkbox"/> P600V \$100	<input type="checkbox"/> PL30V \$100	<input type="checkbox"/> PL35V \$100	<input type="checkbox"/> PL40V \$90	

ADDITIONAL LATERAL FACIAL SUPPORT PARTS

**Note: If ordering an additional Lateral Facial Support, select both a Lateral Facial Support Pad Only from above and an Infinity Mount from below as well*

Option #	Definition	Price
<input type="checkbox"/> 242161	Infinity Dual Mount Assembly*	\$195
<input type="checkbox"/> LM1010	Lateral Facial Support*	\$125

ANTERIOR HEAD SUPPORT



	DYNAMIC FOREHEAD STRAP	DFS ²	STRAP CAP	STATIC FOREHEAD STRAP
ADULT	<input type="checkbox"/> DFS10 \$289	<input type="checkbox"/> DFSQ10 \$349	<input type="checkbox"/> CAP10 (black) \$400	<input type="checkbox"/> HU10 \$315
PEDS	<input type="checkbox"/> DFS30 \$289	<input type="checkbox"/> DFSQ30 \$349	<input type="checkbox"/> CAP30-R (red) \$400	
			<input type="checkbox"/> CAP30-B (blue) \$400	

CUSTOM MOUNTING OPTIONS

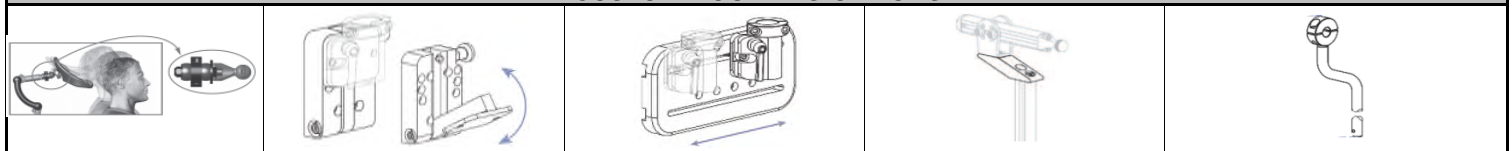













	FLEX INTERFACE BRACKET	UNIVERSAL SWING-AWAY MOUNT	SLIDE MOUNT	PRO OFF-SET MOUNTING SYSTEM	ONYX REARWARD OFF-SET VERTICAL ROD
<input type="checkbox"/> M9450 (hard)	\$185	<input type="checkbox"/> M5000 \$100	<input type="checkbox"/> M7010 \$95	<input type="checkbox"/> PRC7070 \$163	<input type="checkbox"/> OX6030 \$60
<input type="checkbox"/> M8451 (soft)	\$185				

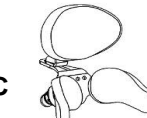

TOOLS

✓	Option #	Definition	Price
<input type="checkbox"/>	BOLT LUBE	Bolt Lube	\$0
<input type="checkbox"/>	T2500	Tool Kit	\$3.33

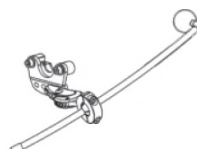
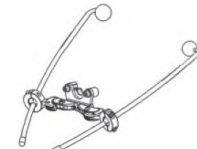

Pad Styles

SINGLE SUB-OCCIPITAL	 <p>10" Pad Large OCC SS10 PAD = 10"w X 5"h SUB OCC = 9"w X 3"h</p>	 <p>6" Pad Large OCC SS8 PAD = 6"w X 4"h SUB OCC = 9"w X 3"h</p>	 <p>6" Pad Small OCC SS4 PAD = 6"w X 4"h SUB OCC = 8"w X 2"h</p>	 <p>5" Pad Small OCC SS3 PAD = 5"w X 2-1/4"h SUB OCC = 8"w X 2"h</p>
	 <p>8" Pad Size 1 OCC 8 PAD = 8"w X 5"h SUB OCC = 8"w X 3"h</p>	 <p>10" Pad Size 1 OCC 5 PAD = 10"w X 5"h SUB OCC = 8"w X 3"h</p>	 <p>6" Pad Size 2 OCC 2 PAD = 6"w X 4"h SUB OCC = 4"w X 3"h</p>	 <p>6" Pad Size 1 OCC 1 PAD = 6"w X 4"h SUB OCC = 8"w X 3"h</p>
	 <p>8" Pad Size 3 OCC 7 PAD = 8"w X 5"h SUB OCC = 4"w X 3"h</p>	 <p>5" Pad Size 4 OCC 6 PAD = 5"w X 2-1/4"h SUB OCC = 4"w X 2-1/2"h</p>	 <p>6" Pad Size 3 OCC 4 PAD = 6"w X 4"h SUB OCC = 4"w X 3"h</p>	 <p>5" Pad Size 3 OCC 3 PAD = 5"w X 2-1/4"h SUB OCC = 4"w X 3"h</p>
	 <p>8" Pad Size 3 OCC 7 PAD = 8"w X 5"h SUB OCC = 4"w X 3"h</p>			

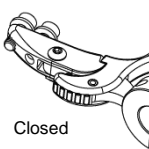
Lateral Facial Supports

MOUNTING HARDWARE	 Unilateral	 Bilateral	 Infinity Mount	 Open  Closed LM115
--------------------------	---	--	---	---

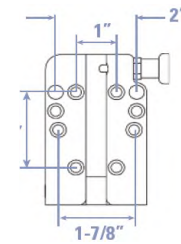
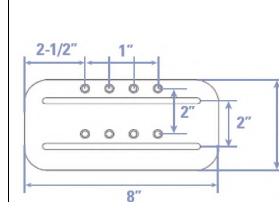
CUSTOM MOUNTS

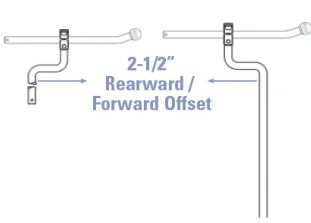
 <p>1" 2" 1-7/8"</p>	 <p>2-1/2" 1" 2" 2" 4" 8"</p>	 <p>Flip horizontal bar for 1-1/2" of forward adjustment</p>	 <p>2-1/2" Rearward / Forward Offset</p>
UNIVERSAL SWING-AWAY MOUNT	SLIDE MOUNT	PRO OFF-SET MOUNTING SYSTEM	ONYX REARWARD OFF-SET VERTICAL ROD



Sunrise Medical (US) LLC