

LEVO compact-easy LCEV

SERVICEMANUAL



This service manual is designed for use by your LEVO dealer and authorized service technicians.

Please carefully read these instructions before carrying out maintenance work on your wheelchair.

This service manual must be read in connection with the instruction manual.

Alterations in constructional and technical manner or to the electronic require the written authorisation of LEVO AG, otherwise no warranty or product liability will be accepted.

Contents

SERVICEMANUAL	Fehler! Textmarke nicht definiert.
1. Introduction	3
2. Accident prevention & safety	3
3. Adjustments – general instructions	3
4. Repairs – general instructions	3
5. Tools & torques	4
6. Important notes	4
7. Recommended safety checks	4
8. Adjustments	5
8.1. Seat depth.....	5
8.2. The backrest and seat upholstery	5
8.3. Rear wheel position	6
8.4. Seat inclination	6
8.5. The castor axle	7
8.6. The leg supports.....	7
8.7. The footrest.....	8
8.8. The armrests.....	8
9. Repairs	9
9.1. Replacing tire/inner tube of rear wheels	9
9.2. Repairing the inner tube.....	10
9.4. Replacing the gas springs	11
9.5. Replacing the actuator (lifting motor)	11
9.6. Replacing the control switch	12
9.7. Replacing the battery-/ electronic box	12
9.8. Replacing the batteries.....	13
10. Testing the wheelchair	13
11. Cleaning	13
12. Technical Data	14
13. Crash Testing	14

1. Introduction

Your LEVO *compact-easy* is maintenance-free dispensing the user with the need for further maintenance work except for charging the battery and cleaning the wheelchair on a regular basis.

Due to its complex design, the wheelchair should be checked for safety at least once a year by your LEVO dealer or authorized technician.

This service manual has been designed for use by your LEVO dealer or authorized technician. It contains all information required to carry out safety checks and repair works on your LEVO *compact-easy*. It will ensure that your wheelchair is a reliable, safe and helpful means of transport.

Always read and apply this service manual in connection with the instruction manual.

2. Accident prevention & safety

Accidents can happen. Be aware of possible dangers when carrying out tests or works on your wheelchair. You should take suitable preventive measures to ensure your own safety and that of other persons.

3. Adjustments – general instructions

Depending on the ability of the user's friends and relatives, they may carry out some of the adjustment works themselves. This manual will tell you how to proceed. However, when delivered, your wheelchair should be adjusted to your personal needs by your LEVO dealer or authorized technician.

4. Repairs – general instructions

Service and repair works on the LEVO *compact-easy* should only be carried out by a LEVO dealer or authorized technician.

- Repairs: For advice in all repairs in Switzerland contact LEVO AG if in Switzerland. For all other countries contact your local LEVO agent. Addresses are given at the front of this instruction and service manual.
- Major repairs: For all major repairs e.g. bent or damaged frame always replace complete components. Never try to repair damaged steelwork or components.
- Replacement parts: Factory replacement components should be used in all repairs, these are available from LEVO AG. To order parts see the parts list drawings at the end of this manual.

Caution: check that the LEVO *compact-easy* is not in the sitting position before carrying out any maintenance or repair work on the wheelchair's stand-up mechanism! Risk of accident! Follow the instructions given in the relevant sections of the service manual!

5. Tools & torques

The following tools are required to carry out maintenance work:

Screw size	Torque in Nm	Allen key	Cross blade crewdriver	Spanner
M4	3	2.5mm	Flat blade screwdriver	10 mm
M5	6	3 mm	Soft headed hammer	13 mm
M6	10	4 mm	Torque wrench:	17 mm
M8	25	5 mm	0 bis 50 Nm	27 mm
M10	50	6 mm		
		8 mm		

6. Important notes

- Do not reuse Nyloc nuts. Always replace with a new Nyloc nut.
- Always use thread locking compound.
- Always use recommended components and parts available from LEVO AG.
- Do not modify or repair the frame.
- LEVO AG is responsible for any repairs on gas springs, actuators and electronic parts.

7. Recommended safety checks

Please note that the following safety checks should be carried out at least on an annual basis. Have them carried out only by your LEVO dealer or an authorized technician. If a defect occurs, immediately discontinue using the wheelchair until the defect is remedied.

1. Fold down the backrest and reset. Having put the backrest back in place, check that the quick release bolts lock correctly. Rectify possible defects.
2. Check the frame for possible defects. Replace defective parts if in need of repair.
3. Check seat and backrest covers for possible wear and replace, if necessary.
4. Check the condition of straps, belts and catches and replace, if necessary.
5. Check that nuts, screws, joints and plastic parts are securely tightened as well as for proper condition. Rectify possible defects.
6. Check that push handles and handle covers fit tightly. Rectify possible defects.
7. Check brakes for adequate braking efficiency. Rectify possible defects.
8. Check that front castors and rear wheels run smoothly and are securely fastened. Check tire pressure and the tread of the tire of rear wheels.
9. Check all electrical cables for abrasion marks and safe operation. Rectify possible defects.
10. Check all electrical connections for signs of corrosion and safe operation. Rectify possible defects.
11. Clean batteries and connections. Check battery capacity and inform the customer of its condition. Recharge the battery before returning the wheelchair to the customer.
12. Check the stand-up mechanism and its proper operation. Rectify possible defects.

8. Adjustments

8.1. Seat depth

The seat depth is adjustable and can be adjusted exactly to the users upper leg length. This is important for a straight, comfortable and correct standing position.

Attention: the seat depth incorrectly adjusted can cause pain, pressure sores or malpositions. This adjustment may only be carried out by a LEVO dealer or a qualified specialist!

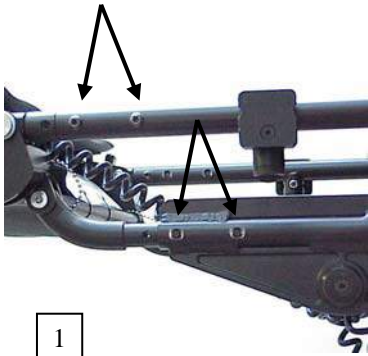

- Drive the seat up into a comfortable working position.
- Remove the seat upholstery.
- Unscrew all four hexagonal screws using a 4 mm Allen key at both inner edges of the adjusting levers as well as those at the outer edges of the seat supports and remove them (see photo 1).
- Adjust the seat to the desired depth by pulling all four rear seat support and adjusting lever tubes simultaneously out of the front tubes or pushing them inside.

- Retighten all eight hexagonal screws again.

Attention: the hexagonal screws for the seat depth adjustment are safety coated with Tuflok. They can be used approx. three times until the coating has worn off. For safety reasons use new screws after a couple of adjustments!

8.2. The backrest and seat upholstery

The surface flexibility of the backrest upholstery can be adjusted using the velcro fasteners. The backrest can be tightened (for a more upright seated posture) or relaxed (for more back support).

The seat upholstery can be similarly tightened or relaxed by use of velcro fasteners. As a rule it should be as taut as possible. Depending on the height of the cushioning in question, it may be necessary to loosen upholstery surface tension to be able to sink the cushioning down between the two seat supports.

If the seat depth must be adjusted the seat upholstery depth can also be adjusted by adding or removing one or two velcro straps (see photo 2). When adjusting the seat depth make sure that the flap of the backrest upholstery covers the seat by a minimum of 12 cm (see photo 2).

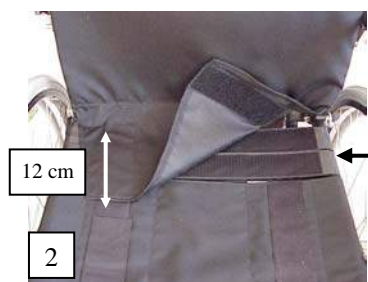

The chest strap is fixed to the backrest upholstery by use of velcro fasteners. It can therefore be adjusted in height.

8.3. Rear wheel position

The axle adapter mounted as standard on your LEVO *compact-easy* depends on the seat depth.

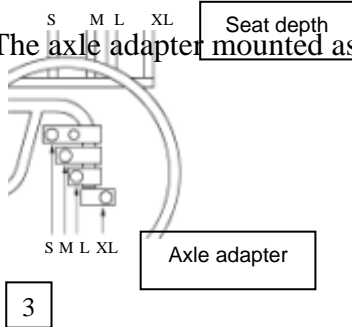

- Seat depth S: axle adapter S mounted.
- Seat depth M: axle adapter M mounted.
- Seat depth L: axle adapter L mounted in forward direction.
- Seat depth XL: axle adapter L mounted in rearward direction. See also illustration 3.
- In order to render the chair more or less tippy it is possible to mount a different axle adapter (see chapter 9.3.).
Example: Mounting the axle adapter M on a chair with seat depth L makes the chair tippier. Mounting the axle adapter L in rearward direction makes it more stable.
- For your own safety we recommend to fit anti-tip rolls always!

8.4. Seat inclination

The standard pre-set inclination is to the rear. By altering the height of the axle adapter it is possible to set this inclination to anything between 2° (horizontal) and 10° to the rear (see chart below). To ensure these alterations do not compromise safety in the standing position, the castor forks must be adjusted appropriately!

Standard				
Seat depth	Seat height	Dimension rear wheel	Distance a	Angle
M	48	22"	45 mm	7°
L	51	24"	45 mm	6°
L	54	24"	20 mm	3°
XL	57	26"	30 mm	5°

Maximum	
Distance a	Angle
20 mm	4°
20 mm	2°
20 mm	3°
20 mm	3°

Minimum	
Distance a	Angle
60 mm	10°
60 mm	8°
60 mm	9°
60 mm	10°

To adjust the seat inclination the axle adapter is adjusted in height:

Unscrew both inside hexagonal screws (A) using a 10 mm spanner and tighten the threaded pin (B) using a 3 mm Allen key (see photo 4). The latter opens up the clamps on the axle adapter.

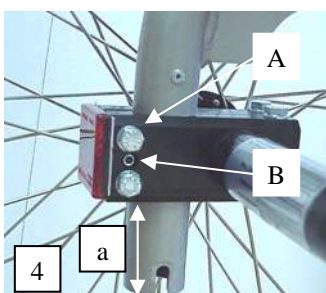

- Adjust the axle adapter to the desired height, unscrew the threaded pin and tighten the two inner hexagonal screws again.

Caution: When adjusting the height of the axle adapter, be sure to adjust the castor angle and the length of the leg plug accordingly (see section 8.5.). In case of large scale adjustments it may even be necessary to replace the leg supports.

Having made the adjustments, it is absolutely vital to ensure that, when standing up, the leg supports still rest on the ground as this is crucial to standing stability (risk of accident)!

8.5. The castor axle

Having made adjustments to the rear axle, be sure to adjust the castor height and angle accordingly. When carrying out these adjustments, it is important to bear the following points in mind:

- The castor axle should stand at a right angle to the ground.
- The castor should always remain in contact with the ground.
- In the uppermost standing position, the leg supports must be resting on the ground.
- Bring the LEVO compact-easy into the standing position.

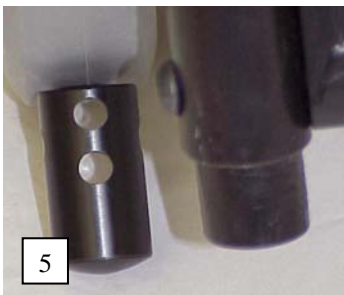

- Unscrew and remove the cylindrical screws using a 4 mm Allen key, then set the plastic leg plug either higher or lower so that the leg supports are standing on the ground. You may have to turn the leg plug by 90°. (see photo 5).



- Unscrew the two cylindrical screws using a 5 mm Allen key and turn the eccentric disc until the axle is sitting vertically (see photo 6). You may have to turn only one of the two eccentric discs. Screw the cylindrical screws tight.

8.6. The leg supports

The leg supports should be replaced when the seat height of the wheelchair has been so greatly adjusted that they no longer reach the ground or reach the ground too soon in the uppermost standing position.

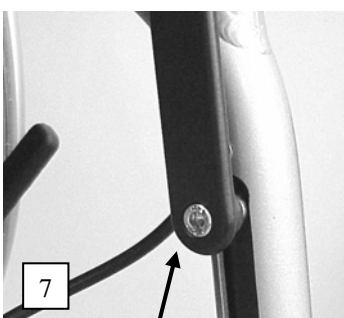

- Remove the rear wheels.
- Remove the footrest (see section 8.7.).
- Loosen the cylindrical screws at both inner edges of the leg supports using a 5 mm Allen key and remove them together with the spacer bushing (see photo 7). Then pull the leg supports out of the frame.
- Replace the leg supports and reassemble in reverse order.

8.7. The footrest

The height of the footrest is not only important for a good sitting position but even more so for the standing position. On delivery you will find the footrest at the second lowest position, if not ordered specifically.

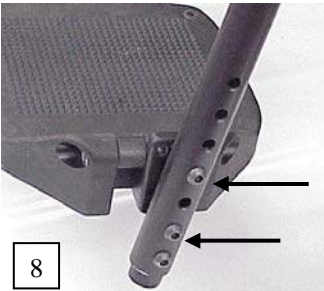

- There is a choice of 5 different heights for mounting the footrest.
- Unscrew the four oval head screws on both outer edges of the footrest using a 4 mm Allen key and set the footrest either higher up or lower down (see photo 8).

There are three possible footrest angle variations:

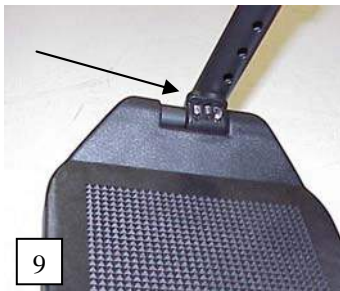

- 4° to the horizontal
- 14° to the horizontal (standard)
- 24° to the horizontal
- Unscrew the four oval head screws on both outer edges of the footrest using a 4 mm Allen key and remove the upper ones. Set the footrest at the desired angle and retighten the screws (see photo 9).

The footrest angle is set as standard at 14° to the horizontal. With the footrest in the lowest possible setting, an angle of 4° is the only practicable variation as the footrest otherwise touches the ground before the leg supports (hence no standing stability!).

With the second lowest setting the only potential variations are 4° and 14°, for the same reasons.

For all higher footrest settings there is a choice of all three angle variations.

8.8. The armrests

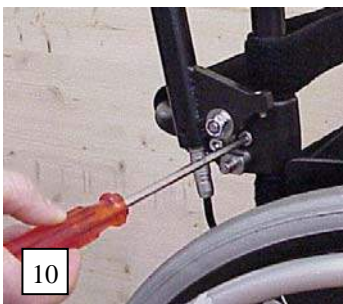

- Remove the backrest upholstery and the velcro straps thereunder.
- Unscrew the hexagonal screw on either side of the armrest holder using a 5 mm Allen key and adjust the armrest holder on both sides simultaneously to the desired height (see photo 10).
- Fix the velcro straps above and below the armrest. The height of the armrest may have to be adjusted to the velcro straps.

The armrest angle can also be adjusted if the armrests don't have the same angle or if they hang downwards after some time of use.

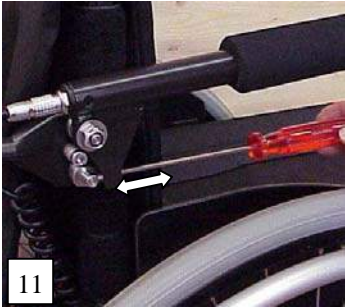

- Screw the threaded pin more towards the rear or the front using a 2 ½ mm Allen key until you reach the desired armrest angle (see photo 11).
- See also Instruction Manual chapter B.3..

9. Repairs

9.1. Replacing tire/inner tube of rear wheels



- Remove the wheel and open the valve before pressing down on it to let out the air (see photo 12).



- Using a bicycle tire wedge, ease both sides of the tire over the wheel rim and pull the inner tube out of the tire (see photo 13).
- Replace the inner tube by forcing one side of the tire back over the wheel rim, pump up the tire a little, ease the valve through into the hole and lay the inner tube along inside of the tire. Once the whole tube is snug inside the tire, force the other side of the tire back over the wheel rim (starting on the side opposite the valve).
- Check lest the inner tube be caught between tire and rim before pumping it up in line with the manufacturer's recommended tire pressure (see Technical Data, section 12).

9.2. Repairing the inner tube

- Remove inner tube and tire following the steps described under 9.1.
- Repair the hole using a bicycle puncture repair kit and follow the manufacturer's instructions (clean the area around the hole and roughen the tube surface (see photo 14) before applying the vulcanized solution).
- Allow to dry, then firmly attach the rubber patch (see photo 15). Again, first allow to dry, then pump up the tube to check that the patch is airtight).
- Replace the inner tube. Once the whole tube is snug inside the tire, force the tire back over the wheel rim (starting on the side opposite the valve).
- Check lest the inner tube be caught between tire and rim before pumping it up in line with the manufacturer's recommended tire pressure (see Technical Data, section 12).

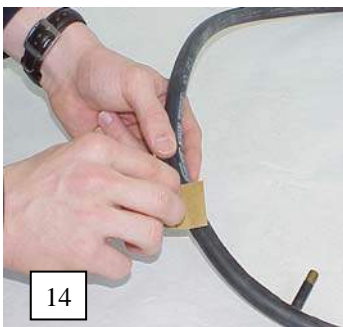

9.3. Replacing the axle adapter

There are a variety of axle adapters available by use of which the wheel axle can be set further forward or further back to increase or decrease respectively the tendency of the wheelchair to tip over, see section 8.3..

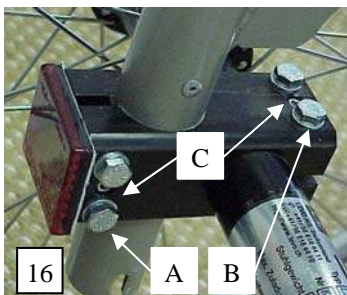

- Loosen the inside (A) and top (B, on the right hand side, but bottom on the left) hexagonal screws using a 10 mm spanner, then tighten both threaded pins (C) using a 3 mm Allen key (see photo 16).
- Slide the axle adapter off the tubular frame and the axle itself and replace it.
- Set the new axle adapter to the desired height, loosen the two threaded pins and screw the two hexagonal screws tight.

9.4. Replacing the gas springs

There are a variety of gas springs of different strength available (e.g. L-spring = 600 N).

Warning: The gas springs are pressurized and are potentially dangerous. Always fit or remove them when they are extended. NEVER try to fit or remove when they are compressed.

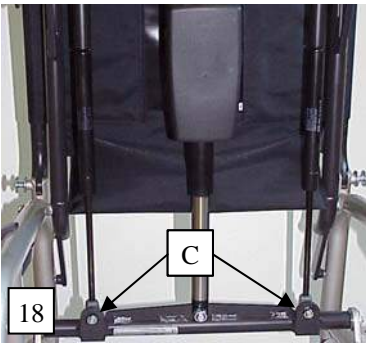

- Lift up the spring clip (A) along the plastic ball joint (B) and lift the joint off (see photo 17). It is not necessary to remove the spring clip (A).
- Drive the seat approx. 4 cm down, so that the plastic ball joints (B) lay in front of the drive shaft.

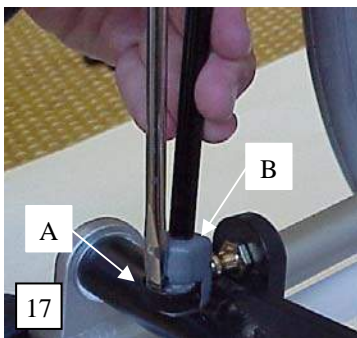

- Unscrew the gas springs turning to the right out of the rear connecting rod (see photo 18).
- Mount in reverse order making sure the gas spring is fully screwed home and that the lock-nuts (C) are tight.

9.5. Replacing the actuator (lifting motor)

Warning: The gas springs are pressurized and are potentially dangerous. Always fit or remove the actuator when the gas springs are extended. NEVER try to fit or remove the actuator when the gas springs are compressed.

Disconnect the actuator plug from the battery-/ electronic box.



- Unscrew the lock nut at the drive shaft using a 17 mm spanner and a 8 mm Allen key - (see photo 19).
- Have a strong person pull the seat down so that the gas springs are slightly pressurized and the tension on the cylindrical screw is removed. Remove now the cylindrical screw from the drive shaft. Let the seat slowly be carried back into the fully upright position.
- Loosen the lock nuts at the rear connecting rod using a 17 mm spanner and remove the cylindrical screws using a 8 mm Allen key (see photo 19). Remove the actuator.
- Mount the rear end of the new actuator first, then drive the seat down so that the shaft of the new motor connects with the drive shaft. Reassemble in reverse order.

9.6. Replacing the control switch

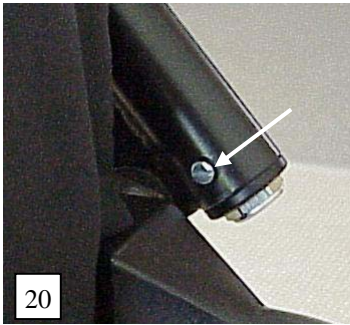

- Disconnect the battery plug from the rear end of the armrest.
- Unscrew the little flat head screw on the inner rear edge of the armrest using a flat blade screwdriver (see photo 20).

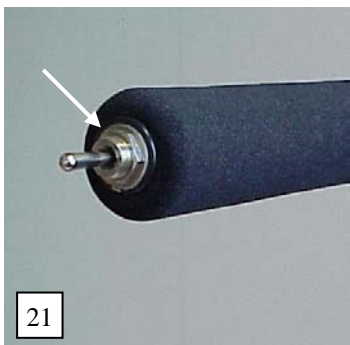

- Loosen the hexagon thin nut at the front of the control switch using a 14 mm spanner (see photo 21). Remove the thin nut and washer.
- Pull out the control switch to the rear.
- Cut-off the defective control switch by use of a cable cutter and solder on the new control switch. Be sure to take into account the different cable colors.
- Mount in reverse order.

9.7. Replacing the battery-/ electronic box

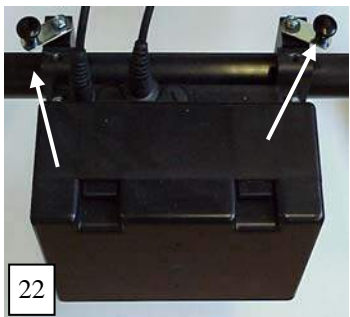

- Disconnect the actuator plug and the battery plug from the battery-/electronic box.
- Push the two mushroom shaped buttons to the outside (see photo 22).
- Remove the battery-/ electronic box.
- Mount the new battery-/ electronic box in reverse order.

Attention: Of the battery-/ electronic box only the batteries and the cover can be replaced! It is not admissible to open the electronics or to remove parts thereof (no warranty)! In case of an electronic defect the complete battery-/ electronic box must be replaced!

9.8. Replacing the batteries



- Depress the four plastic tabs on the battery cover and remove the cover from the battery and electronic unit (see photo 23).
- **Caution:** depress all four tabs simultaneously, not only the two upper ones. The two lower ones may break off!
- Take out the batteries. In so doing, disconnect the pin contacts.
- Install the batteries in reverse order.

Attention: Always replace both batteries together, never just one!

Caution: When working on the batteries take care not to short-circuit them with metal tools etc.. Always take off wrist watches and jewelry. When reconnecting the batteries check that the cables are connected to the correct terminals.

Caution: Getting into contact with acid is dangerous. After contact with acid immediately rinse off spilt acid from your body with water and consult your doctor. Immediately take off all clothes covered with acid. Always clean your hands after having carried out works on batteries.

10. Testing the wheelchair

After having carried out repairs on a wheelchair, you should always check all functions for correct operation before returning the wheelchair to your customer. The wheelchair should only be returned after all defects have been rectified.

11. Cleaning

Before you return the wheelchair to your customer, make sure that the wheelchair is clean and dry:

- Remove dirt with a damp cloth and wipe dry.
- In the case of stubborn dirt use a mild detergent and warm water for cleaning.
- Never apply furniture polish, spirit or solvents to clean the wheelchair.

12. Technical Data

Measurements

Model	S-M					L-XL				
Seat width	38	40	42	45	48	38	40	42	45	48
Total width	56	58	60	63	66	56	58	60	63	66
Total length	84-86					93-104				
Total height (with backrest)	78					80				
Back upholst. height	31					31				
Seat upholst. height front	48/51					51/54				
Seat upholst. height rear	45/47					47/49				
Seat upholst. depth	29-40					43-54				
Footrest - seat	35-42 / 38-45					38-45 / 41-48				
Weight without wheels	19					20				
Total weight	25					26				

All measurements in cm and kg. Variations due to model-specific adjustments possible.

Tires:

Rear wheels: High pressure tires, 22"/24"/26"

Tire pressure (rear): 7.5 bar

Front castor: airless tires, 5"/6"

Actuator (Lifting motor): Linear drive, 24 VDC, Power ca 3000 N,
Speed max. 9 mm/sec.
Power consumption max. 5.0 A, Protection: IP 51
With low voltage acoustic alarm

Batteries: 2 maintenance-free, rechargeable batteries
24 V, 2.7 Ah

Charger: Transformer 220V - 24V

Gas springs: LCEV/S: 400 N
LCEV/M: 500 N
LCEV/L: 600 N
LCEV/XL: 700 N

Operating temperature range: +5° - +40°

Storage temperature range: -40° - +60°

Clearance: max. 6 cm

Max. height of obstacle: max. 2 cm

Max. permissible gradient/

Cross-fall: max. 3°

Max. weight

incl. body & load: max. 120 kg

13. Crash Testing

Preparations of the **LEVO compact-easy LCEV** before using it for car transportation:

1. The chair has to be equipped and reinforced with the “tight down transportation kit # 32.070.0300” that can be ordered at LEVO AG through your LEVO distributor (see instructions below).
2. The chair has to be tight down by using the Q'Straint 5001-T2 or any restraint system that has been tested and passed the ISO 10542/2 standards (see instructions below).
3. The occupant has to be safely secured by using the Q'Straint Vehicle Anch 3-Pt or any restraint system that has been tested and passed the ISO 10542/2 standards (see instructions below).

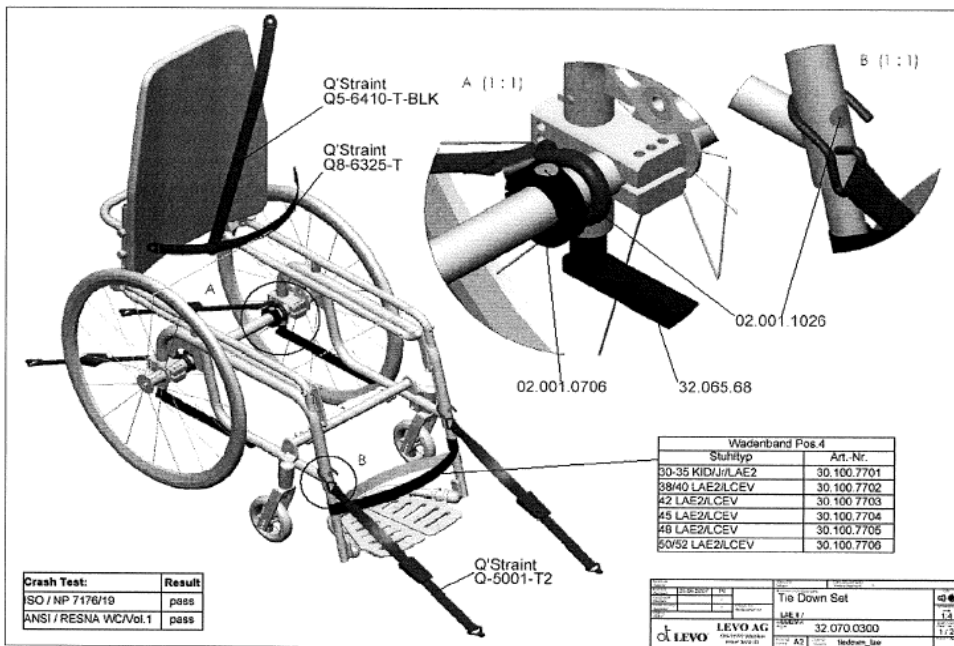

ot The experts in standing