

Viking M / L / XL

Quick Reference Guide

English

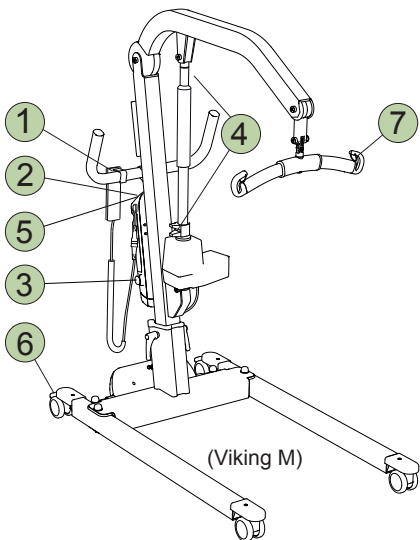

(Viking M)

1 HandControl



Up / Down, adjust the lifting motion up / down, (slowly)
Out / In, adjust the base width

Read the instruction guide for more information.

2 Operation Panel

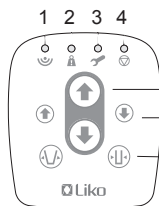

Up / Down, adjust the lifting motion up / down, (slowly)
Out / In, adjust the base width

Indicator lamps (LDS)

1. IR - communication, - receives/ sends IR signals.
2. Overload
3. Service indication
4. Expected Life Time (ELT)

Read the instruction guide for more information.

3 Emergency Stop

Activate:

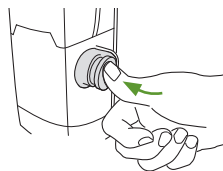

Reset:

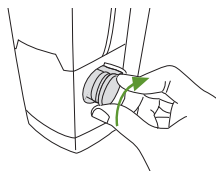

4 Mechanical Emergency Lowering

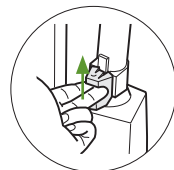

Viking M

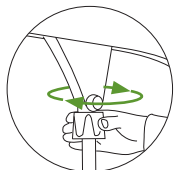

Viking L, Viking XL

5 Electrical Emergency Lowering/Raising

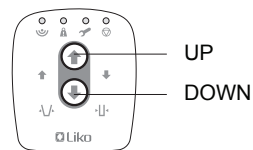

6 Locking the Wheels



Viking M

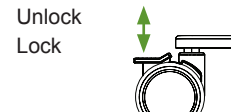

Viking L, Viking XL

7 Latches

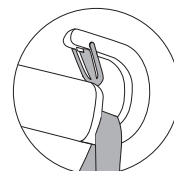

Viking M, Viking L

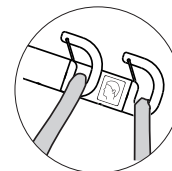

Viking XL

Charging the Batteries

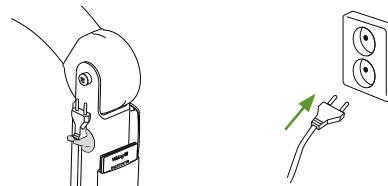

- Charge the lift regularly after use.
- The lift does not function during charging.
- **The lift cannot be charged with the emergency stop engaged.**

Position of the Lift when Lifting

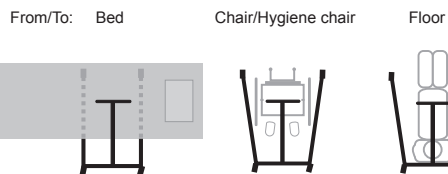

⚠ Unbalanced lifting poses a tipping risk!

Read the instruction guide for more information.

Ergonomics

- Never lift manually – let the lift do the lifting.
- Take it easy. Work calmly and methodically.
- Don't strain your back! Work in a walking stance with your back straight.
- Use the bed's raising and lowering functions.
- Reduce the lever effect. Work close to the patient and the lift.

Cleaning

When necessary, clean the lift with a moist cloth, using warm water or disinfectant.

Simple Troubleshooting

Check to ensure that:

- the emergency stop is not pressed in, see ③
- the battery of the lift is charged
- check that the charger cable is not connected to an electric outlet.

Other Quick Reference Guides

Quick reference guides for Liko's lifts and slings are available

© Copyright Liko AB



Intertek



A Hill-Rom Company

Safety Instructions

- Read the instruction guides for the lift and lifting accessories before use.
- Plan the lifting operation carefully.
- Check to ensure that the sling's strap loops are correctly fastened to the sling bar hooks when the sling strap is extended, but before the patient is lifted from the underlying surface.
- Personnel using the lift are informed of the correct operation and use of the lift.
- **Maximum load: Viking M 205 kg (450 lbs.)
 Viking L 250 kg (550 lbs.)
 Viking XL 300 kg (660 lbs.)**

To retain max. load it is essential to use accessories rated for the same max. load or greater.

IMPORTANT!

This quick reference guide does not replace the lift's instruction guide