

Instructions for use

Elexo XXL

5100 5300

Shower-toilet chair



Important:





Read these instructions carefully before using the Elexo XXL!

Date first used

User

Name

Address

Notes on symbols	
	Read the instructions for use before use.
	Direct current 24V DC.
	Note.
	Applied parts.
	Class 2.

Contents

1.	Introduction	27
1.1.	Introduction	27
1.2.	Safety.....	27
1.3.	Warranty.....	29
2.	Use.....	29
2.1.	First use.....	29
2.2.	Activating.....	29
2.3.	Working with the Elexo XXL.....	29
3.	Operation	32
3.1.	Wheel blocking.....	32
3.2.	Directional wheel.....	32
3.3.	Footrests.....	32
3.4.	Armrests.....	33
3.5.	Moving upwards / downwards.....	33
3.6.	Toilet function.....	34
3.6.1.	In combination with toilet.....	34
3.6.2.	Use of a bedpan or bucket.....	34
3.7.	Charging batteries.....	35
4.	Safety functions	36
4.1.	Emergency stop.....	36
4.2.	Sleep setting.....	36
4.3.	Emergency lowering.....	37
4.4.	On / Off switch	37
5.	Cleaning and maintenance	37
6.	Storage and transport.....	39
7.	Removal of parts.....	39
8.	Technical Specifications.....	39
8.1.	Structure.....	39
8.2.	Drive	40
8.3.	Dimensions	40
9.	Electromagnetic compatibility.....	41

1. Introduction

1.1. Introduction

The height-adjustable electric shower and toilet chair Elexo XXL is a medical device for caring for and washing clients in an ergonomically responsible manner. Comfort is the primary consideration for both the client and the carer.

The Elexo XXL can also be used as a toilet chair, in combination with a bedpan / bucket. The Elexo XXL comprises a base frame and chair component. The chair can be electrically, gradually adjusted in height, in relation to the base frame. The Elexo XXL is thus a multifunctional device. These functions are essential performance of the chair.

The average life-cycle of the Elexo XXL is 10 years, assuming it is cleaned daily and regularly maintained according to the maintenance schedule supplied (See: Chapter 5: Cleaning and Maintenance).

The Elexo XXL is a product with CE-marking. This marking corresponds with directive 93/42/EC and the revised directive 2007/47/EC for medical devices of 21 March 2010. The Elexo XXL has been tested for electro-magnetic radiation according to the norm 60601-1-2.

1.2. Safety

A failure to comply with the following safety points and the further definitions in these instructions for use could lead to hazardous situations. Please read carefully before use.

Use

- Before you start working with the Elexo XXL, check that it has been disconnected from the charger.
- Make sure that the Elexo XXL brake is applied before transferring clients.
- Notify the client before moving the Elexo XXL.
- When the chair is moving upwards or downwards do not place feet on the sub-frame; this will prevent any jamming issues.
- Close the armrests before moving the Elexo XXL upwards.
- Make sure that the client always places his / her arms on the appropriate armrest in order to avoid anything becoming jammed.
- Make sure that the armrests are locked when moving the Elexo XXL.
- Be aware of obstacles when moving upwards and downwards.



- Only relocate and move the Elexo XXL in the lower position.
- When moving the Elexo XXL, do not adjust upwards or downwards.
- Always try to move backwards over obstacles (rather than forwards).
- Set the Elexo XXL to the correct height before using with a toilet.
- It is not permitted to charge the Elexo XXL with more than 220 kg.
- The Elexo XXL may not be used to transport loads other than people.
- Only use original parts, supplied by Lopital.
- The use of components (chargers, cables, actuators, batteries, etc.) that have not been supplied by Lopital may result in increased emissions or decreased immunity of the Elexo XXL.
- Use the Elexo XXL in a clean and tidy working environment.
- The Elexo XXL may only be operated by an authorised person.
- Charge batteries in a well-ventilated, dry space.
- Swimming pool locations are not considered to be 'normal conditions' and will substantially shorten the lifespan of certain components.
- During use of the Elexo XXL, the water temperature may not exceed 43°C.
- Portable and mobile RF communication equipment can affect medical devices.
- Medical electrical devices involve special EMC precautions and must be used as per the EMC information outlined in the instructions for use.
- The chair must not be used adjacent to or stacked on other products. However, should that be necessitated, it must be checked whether the chair functions normally in this configuration too.

Maintenance

- If the charger or cable become damaged, they must be replaced.
- The Elexo XXL must be inspected and serviced at least once a year.
- Servicing and maintenance of the Elexo XXL may only be carried out by persons authorised by Lopital.
- Constructive components of the Elexo XXL may only be replaced by suitably authorised Lopital personnel.
- If erroneous use, transport or an accident leads to deformation of the Elexo XXL, it may not be used and you must contact the supplier.

 **The Elexo XXL Shower-toilet chair must only be operated by persons who have been sufficiently trained and expert personnel who have experience working with the target group.**

 **The Elexo XXL must be used in a clinical setting.**

 **Making changes to the construction could affect the safety of the Elexo XXL. This will also lead to Lopital's liability and warranty conditions being invalidated. As a result, the Elexo XXL will no longer comply with the guidelines for medical devices.**

1.3. Warranty

Lopital products are guaranteed for 2 years with respect to construction and / or material faults. In the event of varying warranty terms, the exact period will be indicated on your invoice; this also serves as the warranty itself.

Components that are subject to wear and tear (such as batteries, handcontrols and cables) will not fall under warranty unless there are clear construction and / or material faults.

2. Use

2.1. First use

Before you use the Elexo XXL, you must check to ensure the components on page 30 are present. These components can be replaced by authorised individuals in the event of damage. These components are the applied parts of the Elexo XXL. These components may come into contact with the user(s) while the Elexo XXL is in use.

2.2. Activating

The Elexo XXL must be activated before use, which can be done by pressing any button on the hand control for 2 seconds (*See figure 1*).

2.3. Working with the Elexo XXL

Step 1

Disconnect the Elexo XXL from the charger if necessary.

Step 2

Activate the Elexo XXL (*See paragraph 2.2 Activating*).

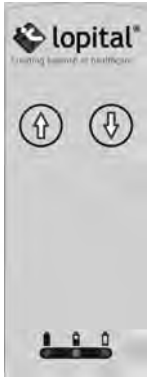

Figure 1 Activating.



Step 3

If necessary, turn the armrests downwards (See paragraph 3.4. Armrests).

Step 4

If necessary, turn the footrests away (See paragraph 3.3 Footrests).

Step 5

The Elexo XXL must be put on the brakes before transferring persons (See paragraph 3.1. Wheel blocking).

Step 6

The client can take a seat in the chair. Support the client if necessary.

Step 7

Place both feet on the footrests and calves against the calf-supports (See paragraph 3.3 Footrests).

Step 8

Close the armrests once the client has taken a seat in the chair (See paragraph 3.4. Armrests).

Step 9

Notify the client about the processes you will be carrying out.

Step 10

Take the chair off the brake when you wish to move it (See paragraph 3.1. Wheel blocking). **Always move the chair in the low position.**

Step 11

When you wish to move the chair upwards / downwards, you must apply the brake (See paragraph 3.5. Moving upwards / downwards).



3. Operation

3.1. Wheel blocking

- The brake can be applied on the Elexo XXL by pushing the blue cap (1) on the wheel downwards (See figure 2).
- To take the Elexo XXL off the brake, the lip (2) on the wheel must be pushed downwards.

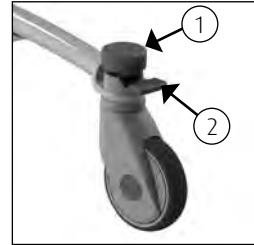

Figure 2 Swivel wheel.

3.2. Directional wheel

- The standard Elexo XXL comes with a swivel wheel that is fitted to the left front side of the device (See figure 3). The direction of the wheel can be blocked by pushing the grey cap (1) on the wheel downwards. This makes it easier to push the device over long distances as the chair is less inclined to move sideways.
- In order to remove the blocking, the lip (2) on the wheel must be pushed downwards.

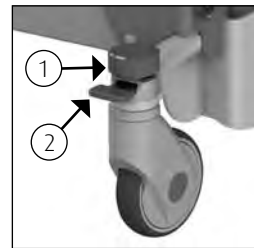



Figure 3 Directional wheel.

3.3. Footrests

- Before the client takes a seat in the Elexo XXL, the footrests must be raised slightly and turned outwards. There is now sufficient room in front of the chair and the client can easily take a seat.
- Once the client has taken a seat, the carer or client raises one leg, the carer then turns the footrest forwards until it falls into the lock. The client can then rest their foot on the support.
- The same procedure is then carried out with the other leg.



Figure 4 Footrest.

 **Always replace this component on the chair when you have finished using it. This will avoid the component being lost.**

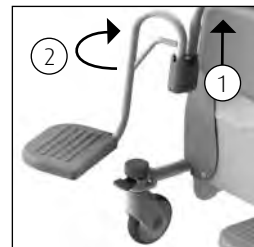

Figure 5 Turning footrest away.

3.4. Armrests

- The independent, turning armrests are easy to use.
- The safety catch is pulled outwards to unlock the armrest (1) (See figure 6).
- The armrest can now easily be turned to the back (2) (See figures 6 & 7).
- Always protect the client when folding the armrests up or down.
- The armrests can also be used as a support when taking a seat or standing up.

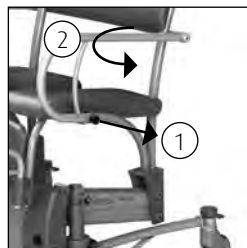

Figure 6 Armrest.



Figure 7
Armrest in turned out position.



When folding the armrest away, avoid the hinging point so as to avoid becoming jammed.



When folding the armrests away, avoid fingers or body parts becoming jammed between the armrest and the back support.



The armrest must not be used as a lever arm (e.g. when moving the chair over an obstacle) or as a push / pull bar. You must not sit on it either. This could damage the Elexo XXL and / or present a hazard.

3.5. Moving upwards / downwards

Moving upwards

- If the client is seated in the chair, first apply the brakes to the wheels and then move the chair upwards.
- Move the chair upwards by pressing the button that shows an 'up' arrow. The seat frame will move up simultaneously (See figure 8).
- You can stop the movement whenever you like by taking your finger off the button.
- During the upward movement, maintain contact with the client.



Figure 8 Moving upwards.



When moving upwards, the position of the chair will tilt from 0° to a maximum of 17° backwards.

Moving downwards

- Move the chair downwards by pressing the button that shows a 'down' arrow. The seat of the Elexo XXL will move downwards simultaneously (See figure 9).
- You can stop the movement whenever you like by taking your finger off the button.
- During the downward movement, maintain contact with the client.



Figure 9 Moving downwards.

Before moving the chair downwards, check to ensure there are no persons or objects in the vicinity of the chair.

3.6. Toilet function

3.6.1. In combination with toilet

- The Elexo XXL can also be moved over the toilet.
- Once the client has taken a seat and the armrests are closed, the carer must move the Elexo XXL to the appropriate height.
- Move the Elexo XXL, if necessary, upwards or downwards to achieve the right position.
- The Elexo XXL can now be moved backwards over the toilet.
- Lower the Elexo XXL, if necessary, to achieve the right position.

The Elexo XXL does not fit over every toilet.

3.6.2. Use of a bedpan or bucket

- If the Elexo XXL is being used as a toilet chair, the special guides under the seat can be used to accommodate a stainless steel / plastic bedpan or bucket.
- The bedpan or bucket is slid in from the back of the chair (See figure 10).

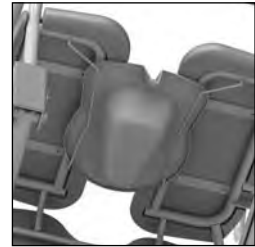

Figure 10 Bedpan.

In order to avoid injuries, we advise the carer to place the bucket before the less able person takes a seat on the chair.

The Lopital plastic bedpan, stainless steel bedpan and bucket must be cleaned and disinfected after use, for example in a bedpan washing unit.

If the Lopital plastic bedpan, stainless steel bedpan or bucket has been used, it must be removed from the chair before the chair is moved or adjusted in height.

3.7. Charging batteries

- The Elexo XXL is an electrically driven high / low shower- toilet chair and works on batteries.
- The charging point is located at the front of the chair on the blue cap on the underside of the device.
(See figure 11).
- If the batteries are almost completely empty of charge, the orange light on the handcontrol will come on; this means that the batteries need to be charged.
- If the LED is on continuous red, the batteries must be charged immediately. The chair can then no longer be used.
- Connect the charger to the Elexo XXL (See figure 11).
- Once the charger is connected to the Elexo XXL, the controls will go into 'sleep' setting (all functions are switched off).



Figure 11 Charging point.



Make sure that you push the plug into the correct position in the charging point.



Only the original charger for the Elexo XXL may be used. If you use another charger, Lopital cannot be held liable for any consequences, such as damage to the electronics.



Once the charger is connected to the Elexo XXL, the controls will go into 'sleep' setting (all functions are switched off).

The charger that must be used for the Elexo XXL is the 'Mascot 2241'.

- When the indicator light on the charger goes green, the batteries are charged. The charger can remain connected even when the batteries are completely charged. Leaving it connected will not cause any damage.
- Disconnect the Elexo XXL from the charger.
- Once activated, the Elexo XXL is now ready for use (See paragraph 2.2 Activating).

LEDs not on: Chair is in 'sleep' setting and cannot be used.

Green light is on: Chair is ready for use.

Orange LED is on: Batteries need charging or batteries are partially charged.



Figure 12 Battery indication on handcontrol.

Orange led blinks: emergency stop has been activated.

Red light blinks: Batteries must be charged (chair can still be used).

Red LED on: Batteries are completely empty and must be charged immediately.



Charge batteries in a well-ventilated, dry space.



After using the chair, connect it to the charger to maintain the batteries. Charge the chair at least once a week!

4. Safety functions

4.1. Emergency stop

On the left hand side, you will find the emergency stop (See figure 13). Operate this button in an emergency; if the upward or downward movement must be stopped immediately. Once the emergency stop has been pressed, the electronic controls will stop working. Operation may be continued once the situation is stable again. Turn the emergency stop a quarter turn to unlock it again (See figure 14).



Figure 13 Emergency stop.



Check whether the danger has passed or the problem has been resolved before resetting the emergency stop.



The orange LED light on the hand control will flash when the emergency stop has been activated.



Figure 14 Emergency stop.

4.2. Sleep setting

After around an hour, the chair will fall into a 'sleep' setting and the battery indication LEDs on the handcontrol will go out. In order to use the chair again, it must be activated (See paragraph 2.2 Activating).

4.3. Emergency lowering

If the controls stop working and the chair is in a raised position, it can be lowered using the emergency lowering button.

Check first to make sure the chair is not in sleep setting!

- Remove the plug from the handcontrol (1) (See figure 15).
- Press the emergency lowering button (2) (See figure 15).

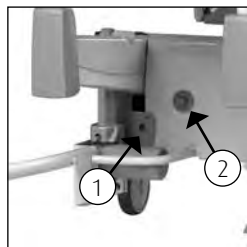

Figure 15
Emergency lowering button.

The chair will now return to the lowest position (make sure no persons or objects are under the chair).

Take the client from the chair and make sure the device is not used until it has been repaired. Place the chair in a safe place and indicate that it is out of order.

4.4. On / Off switch

On the right hand side of the cover cap, there is the on / off switch (See figure 16). If the chair is out of use for an extended period, you are advised to turn it off. This will prevent any unauthorised use of the chair.

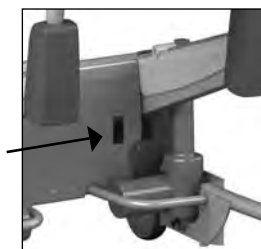

Figure 16 On / off switch.

5. Cleaning and maintenance

The Elexo XXL must be cleaned after every use, with water and regular household cleaning agents. Remove excess soap residues. PUR integrated foam components with IMC coating should be rubbed clean and disinfected. Do not use any abrasive or other aggressive cleaning products (e.g. chlorine bleach). Practical experience has shown that regular household cleaning agents with limited alcohol content (max. 5%) are most suitable for this purpose. The product Neoquat combi® is recommended for disinfection purposes (on the basis of long-term testing). If necessary, the PUR components can be cleaned with a solution of 70% ethanol or propanol.

You must ensure that both the disinfecting and cleaning processes involve the components being rubbed and not just submerged. The time the products must be left on the components has a significant impact upon the lifespan of the PUR components. As a result of the material properties of PUR, contact with sharp objects must be

avoided. This could lead to damage or tears in the material. Finally, we would like to point out that non-critical parts of the PUR components must also be cleaned and decontaminated.

Check the wheels regularly for hairs, dust and soap residues and remove when necessary. Maintenance and repairs to the Elexo XXL may only be carried out by authorised personnel.

Maintenance schedule	
After every use	<ul style="list-style-type: none"> • Clean chair with water and regular household cleaning products.
Daily	<ul style="list-style-type: none"> • PUR foam components must be cleaned and disinfected. • Check to ensure all parts of the Elexo XXL are present, including the footrests and the handcontrol.
Weekly	<ul style="list-style-type: none"> • Clean frame. • Check wheels for hairs, dust and soap residues and remove if necessary. • Check that the chair is still working correctly. • Charge the battery at least once a week.
Annually 	<ul style="list-style-type: none"> • According to the guidelines for medical devices, a chair must be maintained in line with the manufacturer's instructions. This process will preferably be carried out by Lopital or another authorised body. Lopital offers the option of having the chair thoroughly inspected and serviced once a year via Periodic Preventative Maintenance.

6. Storage and transport

During transport and storage, the ambient conditions must remain moderate. In other words, the temperature should remain between -40 and +55 degrees Celsius (-40 to 130 degrees Fahrenheit) and humidity levels should be kept as low as possible. Vibration during transport must be kept to a minimum in order to avoid damaging the hinged mechanisms on the chair. The chair must be switched off during transport (See paragraph 4.4. On / Off switch).

7. Removal of parts

All parts that are replaced or removed can be sent back to Lopital BV. You may also offer the parts to the engineer for destruction. We will ensure that all parts are processed in an environmentally-friendly manner.

If you take care of disposal of the product yourself, you must take account of the fact that batteries and chargers must be disposed of as small chemical waste.

8. Technical Specifications



The Elexo XXL Shower-toilet chair belongs to category 'BF'.



The Elexo XXL Shower-toilet chair is a class 2 product.

The Elexo XXL is splash-proof; this means that the Elexo XXL can be used under the shower. This is given with instruction IPX4.

8.1. Structure

Frame:	stainless steel and steel tubes and plates that are equipped with a 2-layer powder coating
Hinge points :	stainless steel, cover caps made of plastic V0
Wheels :	plastic, Ø 12.5 cm, double blocking facility
Body support :	PUR (polyurethane).
Weight :	75 kg
Maximum permitted load :	220 kg

8.2. Drive

Drive:	2x Actuator 24V DC Push Only 8000N
Battery :	2x battery capacity 7Ah
Charger :	110-240 AC, 50/60 Hz, max 0,35 A, Cable length 2,8 m

8.3. Dimensions

Surface area:	88 cm wide , 115 cm deep
Seat height:	Adjustable: minimum 51 cm , maximum 110 cm

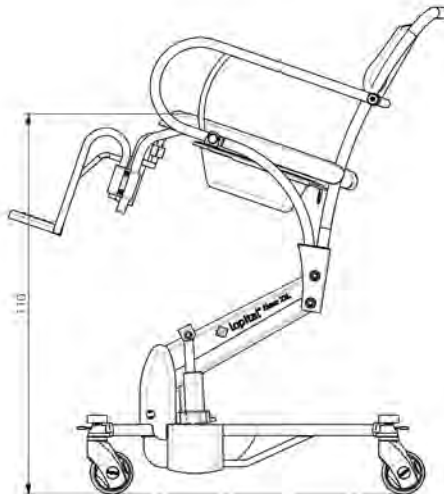
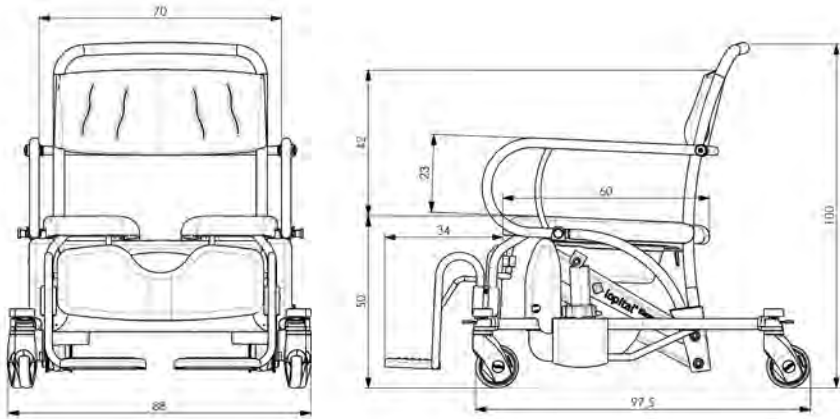

9. Electromagnetic compatibility

Guidance and Manufacturer's declaration-electromagnetic emissions		
The Elexo XXL is intended for use in the electromagnetic environment specified below. The customer or the user of Elexo XXL should assure that it is used in the following environment:		
Emissions Test	Compliance	Electromagnetic Environment - guidance
RF emissions CISPR11	Group 1	The Elexo XXL uses RF energy only for its internal function. Therefore, its RF emissions are very low and are not likely to cause any interference in nearby electronic equipment.
RF emissions CISPR11	Class B	The Elexo XXL is suitable for use in all establishments, including domestic establishments and those directly connected to the public low-voltage power supply network that supplies buildings used for domestic purposes.
Harmonic emissions IEC 61000-3-2	Class A	
Voltage Fluctuations/ Flicker emissions IEC 61000-3-3	Complies	

Guidance and Manufacturer's declaration-electromagnetic immunity			
The Elexo XXL is intended for use in the electromagnetic environment specified below. The customer or the user of the Elexo XXL should assure that it is used in the following environment:			
Immunity Test	IEC 60601-1-2 Test Level	Compliance Level	Electromagnetic Environment - guidance
Electrostatic discharge (ESD) IEC 61000-4-2	±6 kV contact ±8 kV air	±6 kV contact ±8 kV air	Floors should be made of wood, concrete, or ceramic tile. If floors are covered with synthetic material, the relative humidity should be at least 30%.
Electrical fast transient/ burst IEC 61000-4-4	±2 kV for power supply lines ±1 kV for input/ output lines	±2 kV for power supply lines ±1 kV for input/ output lines	Mains power quality should be that of a typical commercial or hospital environment.
Surge IEC 61000-4-5	±1 kV line(s) to line(s) ±2 kV line(s) to earth	±1 kV line(s) to line(s) ±2 kV line(s) to earth	Mains power quality should be that of a typical commercial or hospital environment.
Voltage dips, short interruptions, and voltage variations on power supply input lines IEC 61000-4-11	<5% Un (>95% drop in Un) for 0,5 cycle 40% Un (60% drop in Un) for 5 cycles 70% Un (30% drop in Un) for 25 cycles <5% Un (>95% drop in Un) for 5 seconds	<5% Un (>95% drop in Un) for 0.5 cycle 40% Un (60% drop in Un) for 5 cycles 70% Un (30% drop in Un) for 25 cycles <5% Un (>95% drop in Un) for 5 seconds	Mains power quality should be that of a typical commercial or hospital environment. Elexo XXL is equipped with a battery.
Power frequency (50/60 Hz) magnetic field IEC 61000-4-8	3 A/m	3 A/m	Power frequency magnetic fields should be at levels characteristic of a typical location in a typical commercial or hospital environment.
NOTE Un is the a.c. mains voltage prior to application of the test level			

Guidance and Manufacturer's declaration-electromagnetic immunity

The Elexo XXL is intended for use in the electromagnetic environment specified below. The customer or the user of the Elexo XXL should assure that it is used in the following environment:

Immunity Test	IEC 60601-1-2 Test Level	Compliance Level	Electromagnetic Environment - guidance
<p>RF Common mode/ Conducted Susceptibility IEC 61000-4-6</p> <p>Radiated RF Electromag- netic Field IEC 61000-4-3</p>	<p>3 Vrms 150 kHz to 80 MHz</p> <p>3 V/m 80 MHz to 2,5 GHz</p>	<p>3 V</p> <p>3 V/m</p>	<p>Portable and mobile RF communications equipment should be used no closer to any part of the Elexo XXL, including cables than the recommended separation distance calculated from the equation applicable to the frequency of the transmitter. Recommended separation distance</p> <p>$d = 1,2 \sqrt{P}$</p> <p>$d = 1,2 \sqrt{P}$ 80 MHz to 800 MHz</p> <p>$d = 2,4 \sqrt{P}$ 800 MHz to 2,5 GHz</p> <p>Where P is the maximum output power rating of the transmitter in watts (W) according to the transmitter manufacturer and d is the recommended separation distance in meters (m).</p> <p>Field strengths from fixed RF transmitters, as determined by an electromagnetic site survey,^a should be less than the compliance level in each frequency range.^b</p> <p>Interference may occur in the vicinity of equipment marked with the following symbol:</p> 
<p>NOTE 1 At 80 MHz and 800 MHz, the higher frequency range applies.</p>			
<p>NOTE 2 These guidelines may not apply in all situations. Electromagnetic propagation is affected by absorption and reflection from structures, objects and people.</p>			
<p>a Field strengths from fixed transmitters, such as base stations for radio (cellular/cordless) telephones and land mobile radios, amateur radio, AM and FM radio broadcast and TV broadcast cannot be predicted theoretically with accuracy. To assess the electromagnetic environment due to fixed RF transmitters, an electromagnetic site survey should be considered. If the measured field strength in the location in which the Elexo XXL is used exceeds the applicable RF compliance level above, the Elexo XXL should be observed to verify normal operation. If abnormal performance is observed, additional measures may be necessary, such as re-orienting or relocating the Elexo XXL.</p>			
<p>b Over the frequency range 150 kHz to 80 MHz, field strengths should be less than 3 V/m.</p>			

Recommended separation distance between portable and mobile RF communications equipment and the Elexo XXL			
The Elexo XXL is intended for use in the electromagnetic environment in which radiated RF disturbances are controlled. The customer or the user of the Elexo XXL can help prevent electromagnetic interference by maintaining a minimum distance between portable and mobile RF communications equipment (transmitters) and the Elexo XXL as recommended below, according to the maximum output power of the communications equipment.			
Rated maximum output power of transmitter W	Separation distance according to frequency of transmitter m		
	150 kHz to 80 MHz $d = 1,2 \sqrt{P}$	80 MHz to 800 MHz $d = 1,2 \sqrt{P}$	800 MHz to 2,5 GHz $d = 2,4 \sqrt{P}$
0,01	0,12	0,12	0,24
0,1	0,38	0,38	0,76
1	1,2	1,2	2,4
10	3,8	3,8	7,6
100	12	12	24
For transmitters rated at a maximum output power not listed above, the recommended separation distance d in meters (m) can be estimated using the equation applicable to the frequency of the transmitter, where P is the maximum output power rating of the transmitter in watt (W) according to the transmitter manufacturer.			
NOTE 1 At 80 MHz and 800 MHz, the separation distance for the higher frequency range applies.			
NOTE 2 These guidelines may not apply in all situations. Electromagnetic propagation is affected by absorption and reflection from structures, objects and people.			

Master Dealer:

ProCare Medical

