

Instructions for use

Marina

6100 2300, 6100 2305, 6100 2310, 6100 2320, 6100 2330, 6100 2345 (Hydraulic).
6100 2350, 6100 2355, 6100 2360, 6100 2370, 6100 2380, 6100 2385 (Elektrical).

Shower stretcher



Important:





Read these instructions carefully before using the Marina!

Date first used

User

Name

Address

Notes on symbols	
	Read the instructions for use before use.
	Direct current 24V DC.
	Note.
	Applied parts.
	Class 2.

Contents

1.	Introduction	29
1.1.	Introduction	29
1.2.	Safety	30
1.3.	Warranty	31
2.	Use	33
2.1.	First use	33
2.2.	Activating (only for electrically adjustable versions).....	33
2.3.	Working with the Marina.....	33
3.	Operation.....	34
3.1.	Wheel blocking.....	34
3.2.	Side-bars	35
3.3.	Moving upwards / downwards	36
3.4.	Tilting	37
3.5.	Water drainage	37
3.6.	Charging batteries (only for electrically adjustable versions)	37
4.	Safety functions	39
4.1.	Lock button (only for electrically adjustable versions).....	39
4.2.	Sleep setting (only for electrically adjustable versions)	39
4.3.	Emergency lowering (only for electrically adjustable versions).....	39
4.4.	On / Off switch (only for electrically adjustable versions).....	40
5.	Cleaning and maintenance.....	40
6.	Storage and transport	41
7.	Removal of parts	42
8.	Technical Specifications.....	42
8.1.	Structure	42
8.2.	Drive.....	43
8.3.	Dimensions	43
9.	Checklist for technical problems	45
10.	Relationship with other supports.....	46
11.	Electromagnetic compatibility.....	47

1. Introduction

1.1. Introduction

The Marina shower stretcher is a medical device for caring for and washing clients in an ergonomically responsible manner. Comfort is the primary consideration for both the client and the carer.

The Marina comprises a mobile base frame and a height-adjustable supporting surface with a soft mattress. The stretcher is also mobile. These functions are essential performances of the stretcher. The Marina is multi-functional in use and corresponds to the use of other devices such as beds, wheelchairs and shower chairs, hoisting equipment and sliders such as the EasySlide.

The average life-cycle of the Marina is 10 years, assuming it is cleaned daily and regularly maintained according to the maintenance schedule supplied (*See: Chapter 5 Cleaning and Maintenance*).

The Marina is a product with CE-marking. This marking corresponds with directive 93/42/EC and the revised directive 2007/47/EC for medical devices of 21 March 2010. The Marina has been tested for electro-magnetic radiation according to the norm 60601-1-2.

The Marina is available in the following hydraulic adjustable versions:

- 6100 2300 – Standard.
- 6100 2305 – Wide.
- 6100 2310 – Central braking.
- 6100 2320 – Short.
- 6100 2330 – Long.
- 6100 2345 – Wide and long.

The Marina is available in the following electric adjustable versions:

- 6100 2350 – Standard.
- 6100 2355 – Wide.
- 6100 2360 – Central braking.
- 6100 2370 – Short.
- 6100 2380 – Long.
- 6100 2385 – Wide and long.



1.2. Safety

A failure to comply with the following safety points and the further definitions in these instructions for use could lead to hazardous working situations. Please read carefully before use.

Use

- Before you start work with the Marina, check that it has been disconnected from the charger (For electric adjustable Marina).
- Make sure that the Marina brake is applied before transferring clients.
- Notify the client before moving the Marina.
- Be aware of obstacles when moving upwards and downwards.
- Only relocate and move the Marina in the lower position.
- When moving the Marina, do not adjust upwards or downwards.
- Always try to move backwards over obstacles (rather than forwards).
- It is not permitted to charge the Marina with more than 180 kg.
- The Marina may not be used to transport loads other than people.
- Only use original parts, supplied by Lopital.
- Use the Marina in a clean and tidy working environment.
- The Marina may only be operated by an authorised person.
- The use of components (chargers, cables, actuators, batteries, etc.) that have not been supplied by Lopital may result in increased emissions or decreased immunity of the Marina (For electric adjustable Marina).
- Charge batteries in a well-ventilated, dry space.
- Swimming pool locations are not considered to be 'normal conditions' and will substantially shorten the lifespan of certain components.
- The Marina may not be raised by the upper surface.
- During use of the Marina, the water temperature may not exceed 43°C.
- Portable and mobile RF communication equipment can affect medical devices.
- Medical electrical devices involve special EMC precautions and must be used as per the EMC information outlined in the instructions for use.
- The stretcher must not be used adjacent to or stacked on other products. However, should that be necessitated, it must be checked whether the stretcher functions normally in this configuration too.

Maintenance

- If the charger or cable become damaged, they must be replaced (For electric adjustable Marina).
- The Marina must be inspected and serviced at least once a year.
- Servicing and maintenance of the Marina may only be carried out by persons authorised by Lopital.
- Constructive components of the Marina may only be replaced by suitably authorised Lopital personnel.
- If erroneous use, transport or an accident leads to deformation of the Marina, it may not be used and you must contact the supplier.



The Marina must only be operated by persons who have been sufficiently trained and expert personnel who have experience working with the target group.



The Marina must be used in a clinical setting.



Making changes to the construction could affect the safety of the Marina. This will also lead to Lopital's liability and warranty conditions being invalidated. As a result, the Marina will no longer comply with the guidelines for medical devices.



The Marina may not be tilted by the bed base. If, as a result of this, the motor stops working, it will not be replaced under guarantee.

1.3. Warranty

Lopital products are guaranteed for 2 years with respect to construction and / or material faults. In the event of varying warranty terms, the exact period will be indicated on your invoice; this also serves as the warranty itself.

Components that are subject to wear and tear (such as batteries, handcontrol and cables) will not fall under warranty unless there are clear construction and / or material faults.

Charger
(Electrical
Marina).

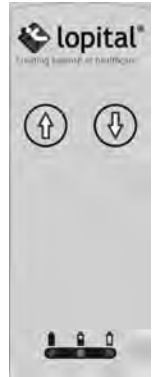

Figure 1 Activating.



2. Use

2.1. First use

Before you use the Marina, you must check to ensure the components on page 32 are present. These components can be replaced by authorised individuals in the event of damage.

These components are the applied parts of the Marina. These components may come into contact with the user(s) while the Marina is in use.

2.2. Activating *(only for electrically adjustable versions)*

The Marina must be activated before use, which can be done by pressing any button on the hand control for 2 seconds *(See figure 1)*.

2.3. Working with the Marina

Step 1

Disconnect the Marina from the charger if necessary.

Step 2

Activate the Marina *(See paragraph 2.2 Activating)*.

Step 3

Always apply the brake on the Marina when transferring clients *(See paragraph 3.1. Wheel blocking)*.

Transfer from bed

Step 4

Place the Marina alongside the bed with the head-end aligned with the head-side of the client.

Step 5

Lower the side-bars of the Marina *(See paragraph 3.2. Side-bars)*.

Step 6

Move the bed base on the Marina to just above the bed mattress and collapse the side-bars downwards.

Step 7

Slide the Marina between the head and foot-end so that it protrudes as far as possible over the bed.

Step 8

Block the wheels on the Marina
(See paragraph 3.1. Wheel blocking).

Step 9

Go to the other end of the bed and place the EasySlide between the client and the Marina.

Step 10

Use the EasySlide to slide the client from the bed to the Marina.

Step 11

Raise the horizontal surface of the Marina a few centimetres and close the side-bars.

Step 12

Take the brake off the Marina and remove the easy-slide
(See paragraph 3.1. Wheel blocking).



During this transfer, the side of the mattress can be either turned inside or out. Turning it out is beneficial as the person being transferred is protected from the rail on the side-bar.

Make sure that the shower stretcher mattress does not get jammed between the horizontal surface of the Marina and the bed.

3. Operation

3.1. Wheel blocking

- The brake can be applied on the Marina by pushing the blue lip (1) on the wheel downwards (See figure 2).
- In order to take the Marina off the brake, the same lip on the wheel must be moved upwards by tapping the upper side of the lip (2) (See figure 2).

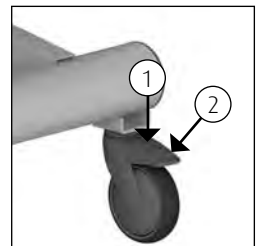

Figure 2 Wheel blocking.

Semi-central braking and moving forwards (Article number: 6100 2310 / 6100 2360)

- The semi-central operating pedal for the brakes is the pedal at the head-end and foot-end on both sides of the stretcher (See figure 3).
- The brake on the Marina can be applied by moving the inside of the pedal at the head and foot end downwards, using your foot (1).
- To take the Marina off the brakes, the pedal must be moved upwards to a horizontal position with your foot.
- The swivel wheel is disengaged by moving the outside of the pedal at the head and foot end downwards with your foot (2).
- The swivel wheel is engaged by moving the pedal back into the horizontal position with your foot.

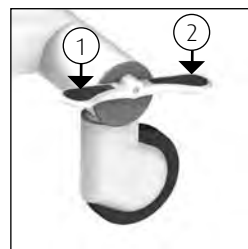

Figure 3 Semi-central braking and moving forward.

3.2. Side-bars

- The Marina is equipped with aluminium side-bars that can be collapsed against the edge of the bed-base so that sliding transfers can be carried out.
- The side-bar is equipped with safeguards so that the client cannot raise the side-bars themselves (See figure 4).
- Before the side-bar is collapsed downwards, the safeguard must be unlocked at the head-end.
- Unlock the safeguard by using one hand to pull the protruding lip inwards and raising the side-bar with your other hand (1) (See figure 4).
- Turn the unlocked side-bar outwards so that the side of the mattress can lie in a horizontal position.
- Collapsed side-bars enable the carer to lean on the centre of the mattress and more easily care for the client.
- Move the side-bar upwards in order to lock it in place again. The side-bar locks automatically.
- When closing the side-bar, the collapsed mattress flap will be lifted back into a vertical position.
- Make sure that the corner flaps fall inwards so that they do not become jammed in the side-bar locks.

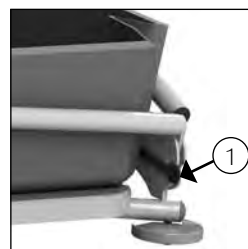

Figure 4 Locking side-bar.

3.3. Moving upwards / downwards

Electrically adjustable versions

Moving upwards

- If the client is lying on the shower stretcher, first put the brake on the wheels and then move the stretcher upwards.
- Move the stretcher upwards by pressing the button that shows an 'up' arrow. The stretcher will then immediately move upwards (See figure 5).
- You can stop the movement whenever you like by taking your finger off the button.
- During the upward movement, maintain contact with the client.
- If the remote control is not being used, it can be hung on the side-bar or on the push-bar.
- Ensure that the curly cable on the operating device does not get jammed.



Figure 5
Moving upwards.

Moving downwards

- Move the stretcher downwards by pressing the button that shows a 'down' arrow. The stretcher will immediately move downwards (See figure 6).
- You can stop the movement whenever you like by taking your finger off the button.
- During the downward movement, maintain contact with the client.



Figure 6
Moving downwards.



Before moving the stretcher upwards, check to ensure there are no persons or objects in the vicinity of the stretcher.

Hydraulically adjustable versions

Moving upwards

- If the client is lying on the shower stretcher, first put the brake on the wheels and then move the stretcher upwards.
- The stretcher is moved upwards by depressing the long part of the foot pedal slowly and evenly (See figure 7).
- During use of the pedal, the carer will stand by the long edge of the Marina so that the carer cannot twist their upper body away from their feet.
- During the upward movement, maintain contact with the client.

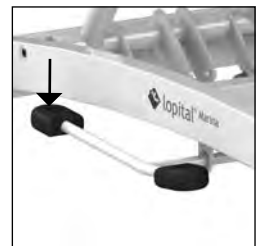

Figure 7 Moving upwards.

Moving downwards

- The stretcher is lowered by depressing the short part of the foot pedal (See figure 8).
- The stretcher lowers under the influence of gravity. The lowering speed can be steadied by keeping the pedal gently depressed.
- During the downward movement, maintain contact with the client.

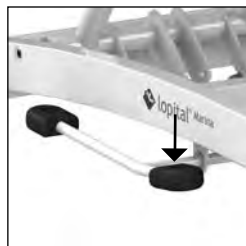

Figure 8 Moving downwards.

3.4. Tilting

- In order to remove water from the mattress during or after showering, the bed base on the Marina can be tilted.
- Turn the lever on the upper frame, under the head end, outwards in order to position the bed base in the drainage position.
- This control can be found on both sides of the stretcher.
- Turn the lever inwards before restoring the bed base to its horizontal position.

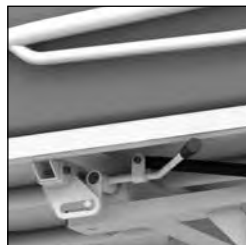

Figure 9 Tilting.

3.5. Water drainage

- Water is drained away from the Marina via a drainage hose.
- Take the hose off the hook and direct it to a drainage point that is as low as possible.
- During transport, always hang the hose on the hook otherwise it may leak and drip.

3.6. Charging batteries

(only for electrically adjustable versions)

- The Marina is an electrically driven high / low stretcher and works on batteries.
- The charging point is located in the centre of the undercarriage (See figure 10).
- If the batteries are almost completely empty of charge, the orange light on the manual control will come on; this means that the batteries need to be charged.
- If the LED is on continuous red, the batteries must be charged immediately. The stretcher can then no longer be used.
- Connect the charger to the Marina (See figure 10).
- Once the charger is connected to the Marina, the controls will go into 'sleep' setting (all functions are switched off).

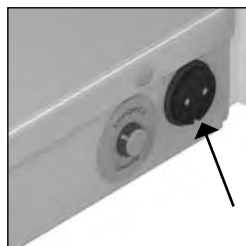

Figure 10 Charging point.



Make sure that you push the plug into the correct position in the charging point.



Only the original charger for the Marina may be used. If you use another charger, Lopital cannot be held liable for any consequences, such as damage to the electronics.



Once the charger is connected to the Marina, the controls will go into 'sleep' setting (all functions are switched off).

The charger that must be used for the Marina is the 'Mascot 2241'.

- When the indicator light on the charger goes green, the batteries are charged. The charger can remain connected even when the batteries are completely charged. Leaving it connected will not cause any damage.
- Disconnect the Marina from the charger.
- Once activated, the Marina is now ready for use (See paragraph 2.2 Activating).

LEDs not on: Stretcher is in 'sleep' setting and cannot be used or the on / off switch is off.

Green light is on: Stretcher is ready for use.

Orange light blinks: Lock button has been activated.

Orange LED is on: Batteries need charging or batteries are partially charged.

Red light blinks: Batteries must be charged (Stretcher can still be used).

Red LED on: Batteries are completely empty and must be charged immediately.

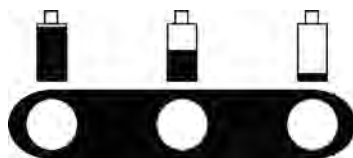

Figure 11 Battery indication on handcontrol.



Charge batteries in a well-ventilated, dry space.



After using the stretcher, connect it to the charger to maintain the batteries. Charge the stretcher at least once a week!

4. Safety functions

4.1. Lock button

(Only for electrically adjustable versions)

The lock button is located in the middle of the undercarriage. Once the lock button has been depressed all electrical functioning will stop. Rotate the lock button a quarter of a turn to the right to unlock it (See figure 12).



Figure 12
Lock button.

The orange LED light on the hand control will flash when the Lock button has been activated.

4.2. Sleep setting *(only for electrically adjustable versions)*

After around an hour, the stretcher will fall into a 'sleep' setting and the battery indication LEDs on the manual control will go out. In order to use the stretcher again, it must be activated (See paragraph 2.2 Activating).

4.3. Emergency lowering

(only for electrically adjustable versions)

If the controls stop working and the stretcher is in a raised position, it can be lowered using the emergency lowering button (See figure 13).

Check first to make sure the stretcher is not in sleep setting!

- Remove the plug from the manual control (1).
- Press the emergency lowering button (2).

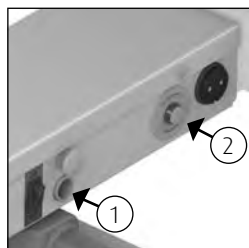

Figuur 13
Emergency lowering button.

The stretcher will now return to the lowest position (make sure no persons or objects are under the stretcher). Take the client from the stretcher and make sure the device is not used until it has been repaired. Place the stretcher in a safe place and indicate that it is out of order.

4.4. On / Off switch

(only for electrically adjustable versions)

In the centre of the undercarriage, there is an on / off switch. If the shower stretcher is not used for an extended period, you are advised

5. Cleaning and maintenance

The Marina must be cleaned after every use, with water and regular household cleaning agents. Remove excess soap residues. Do not use any abrasive or other aggressive cleaning products (e.g. chlorine bleach). Practical experience has shown that regular household cleaning agents with limited alcohol content (max. 5%) are most suitable for this purpose.

The product Neoquat combi® is recommended for disinfection purposes (on the basis of long-term testing). For the best and most efficient cleaning of the mattress and the bed base, the mattress can be lifted up and removed. Dry the plate on which the mattress lies.

Check the wheels regularly for hairs and dust and remove when necessary. Maintenance and repairs to the Marina may only be carried out by authorised personnel.

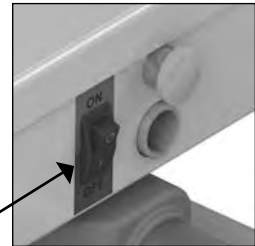



Figure 14 On / off switch.

Maintenance schedule	
After every use	<ul style="list-style-type: none"> • Clean and disinfect mattress.
Daily	<ul style="list-style-type: none"> • Clean stretcher with water and regular household cleaning products.
Weekly	<ul style="list-style-type: none"> • Clean frame. • Check wheels for hairs, dust and soap residues and remove if necessary. • Check that the stretcher is still working correctly.
Annually 	<ul style="list-style-type: none"> • According to the guidelines for medical devices, a stretcher must be maintained in line with the manufacturer's instructions. This process will preferably be carried out by Lopital or another authorised body. Lopital offers the option of having the stretcher thoroughly inspected and serviced once a year via Periodic Preventative Maintenance.

6. Storage and transport

During transport and storage, the ambient conditions must remain moderate. In other words, the temperature should remain between -40 and +55 degrees Celsius (-40 to 130 degrees Fahrenheit) and humidity levels should be kept as low as possible. Vibration during transport must be kept to a minimum in order to avoid damaging the hinged mechanisms on the stretcher.

7. Removal of parts

All parts that are replaced or removed can be sent back to Lopital BV. You may also offer the parts to the engineer for destruction. We will ensure that all parts are processed in an environmentally-friendly manner.

If you take care of disposal of the product yourself, you must take account of the fact that batteries and chargers must be disposed of as small chemical waste.

8. Technical Specifications



The Marina Shower stretcher belongs to category 'BF'.



The Marina Shower stretcher is a class 2 product.

The Marina is splash-proof; this means that the Reflex can be used under the shower. This is given with instruction IPX4.

8.1. Structure

Base:	aluminium + 2 layer powder coating
Upper frame:	aluminium + 2 layer powder coating
Side-bars:	aluminium + 2 layer powder coating
Hinges:	aluminium + 2 layer powder coating
Wheels:	plastic Ø 12.5 cm, double blocked, with semi-central brake Ø15 cm
Bath + covers:	ABS with PMMA coating
Mattress film:	PVC
Attachment components:	stainless steel + galvanised steel

Weight

6100 2300	68 kg
6100 2305	74 kg
6100 2310	75 kg
6100 2320	70 kg
6100 2330	76 kg
6100 2345	76 kg
6100 2350	75 kg

6100 2355	78 kg
6100 2360	79 kg
6100 2370	74 kg
6100 2380	80 kg
6100 2385	80 kg

Maximum load: 180 kg

8.2. Drive

High-low drive:	Hydraulic or electric, push-only
Control box:	24 VDC, max. 250W
Battery:	2 x 12V, 7Ah
Battery charger:	110-240 AC, 50/60 Hz, Max 0,35 A, Cable lenght 2,8 m

8.3. Dimensions

External dimensions:

6100 2300	209 x 80 x 62 / 116 cm (l x w x h).
6100 2305	209 x 80 x 62 / 116 cm (l x w x h).
6100 2310	209 x 80 x 62 / 116 cm (l x w x h).
6100 2320	189 x 80 x 62 / 116 cm (l x w x h).
6100 2330	225 x 80 x 62 / 116 cm (l x w x h).
6100 2345	225 x 90 x 62 / 116 cm (l x w x h).
6100 2350	209 x 80 x 62 / 116 cm (l x w x h).
6100 2355	209 x 90 x 62 / 116 cm (l x w x h).
6100 2360	209 x 80 x 62 / 116 cm (l x w x h).
6100 2370	189 x 80 x 62 / 116 cm (l x w x h).
6100 2380	225 x 80 x 62 / 116 cm (l x w x h).
6100 2385	225 x 90 x 62 / 116 cm (l x w x h).

Net lying space:

6100 2300	ca. 195 x 65 cm (l x w).
6100 2305	ca. 195 x 75 cm (l x w).
6100 2310	ca. 195 x 65 cm (l x w).
6100 2320	ca. 170 x 65 cm (l x w).
6100 2330	ca. 206 x 65 cm (l x w).
6100 2345	ca. 206 x 75 cm (l x w).
6100 2350	ca. 190 x 65 cm (l x w).
6100 2355	ca. 190 x 75 cm (l x w).

6100 2360	ca. 190 x 65 cm (l x w).
6100 2370	ca. 170 x 65 cm (l x w).
6100 2380	ca. 206 x 65 cm (l x w).
6100 2385	ca. 206 x 65 cm (l x w).

Mattress edge height:	ca. 20 cm
Bed base height:	minimum 45 cm, maximum 99 cm
Water drainage hose:	Internal Ø 4 cm
Wheel base:	140 cm
Track width:	63 cm
Undercarriage height:	13 cm

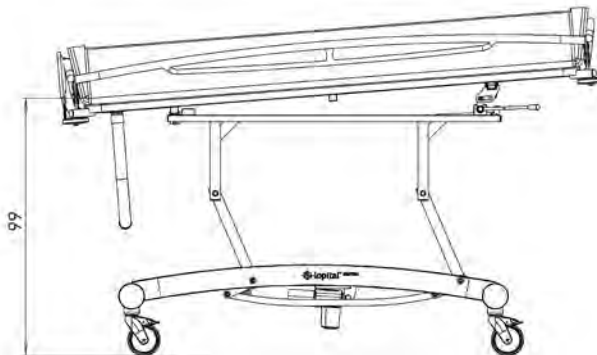
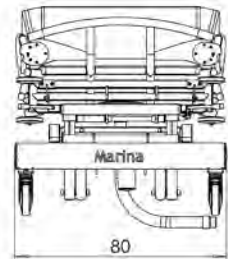
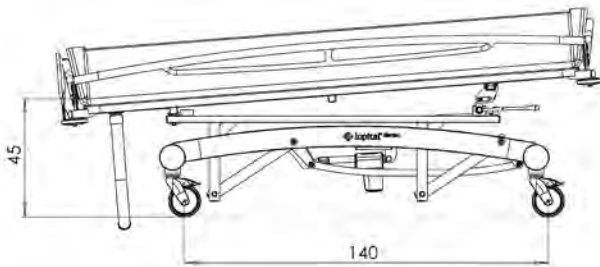

9. Checklist for technical problems

Problem	Cause	Solution
Marina is awkward to move	Dirt and soap between wheels	Clean wheels
Marina does not move upwards or downwards	Lock button used	Turn Lock button 90 degrees to the right
	Battery empty	Charge battery
	Plugs removed	Check plugs (to side of control box).
	Manual controls not working	Check plugs Contact Lopital Nederland B.V.
The light on the charger is not on	Charger is not plugged in	Connect charger
	Charger is not working	Contact Lopital Nederland B.V.
Marina stops	Lock button used	Turn Lock button 90 degrees to the right
	Technical issue	Contact Lopital Nederland B.V.

10. Relationship with other supports

EasySlide

The EasySlide is the ideal device for transferring from bed to stretcher and vice versa. The physical burden and time required when using the EasySlide is minimal. The EasySlide is suitable for most bed and chair transfers from and to the Marina.

Hoist

The Marina has been designed for use with a hoist. The shower stretcher has an undercarriage height of 13 cm from a bed height of 65 cm.

Wheelchair

In lower settings of 50-55 cm, clients can be transferred from shower stretcher to wheelchair and vice versa. An ideal device to be used during this operation is the small EasySlide (and possibly a sliding board).

Bed

The Marina is primarily used to wash clients while lying down. Less able persons can be moved, using the EasySlide, from any (high or low) bed to the Marina in a lying position. The Marina must be brought to the same height as the bed to carry out this process.

11. Electromagnetic compatibility

Guidance and Manufacturer's declaration-electromagnetic emissions		
The Marina is intended for use in the electromagnetic environment specified below. The customer or the user of Marina should assure that it is used in the following environment:		
Emissions Test	Compliance	Electromagnetic Environment - guidance
RF emissions CISPR11	Group 1	The Marina uses RF energy only for its internal function. Therefore, its RF emissions are very low and are not likely to cause any interference in nearby electronic equipment.
RF emissions CISPR11	Class B	The Marina is suitable for use in all establishments, including domestic establishments and those directly connected to the public low-voltage power supply network that supplies buildings used for domestic purposes.
Harmonic emissions IEC 61000-3-2	Class A	
Voltage Fluctuations/ Flicker emissions IEC 61000-3-3	Complies	

Guidance and Manufacturer's declaration-electromagnetic immunity			
The Marina is intended for use in the electromagnetic environment specified below. The customer or the user of the Marina should assure that it is used in the following environment:			
Immunity Test	IEC 60601-1-2 Test Level	Compliance Level	Electromagnetic Environment - guidance
Electrostatic discharge (ESD) IEC 61000-4-2	±6 kV contact ±8 kV air	±6 kV contact ±8 kV air	Floors should be made of wood, concrete, or ceramic tile. If floors are covered with synthetic material, the relative humidity should be at least 30%.
Electrical fast transient/ burst IEC 61000-4-4	±2 kV for power supply lines	±2 kV for power supply lines	Mains power quality should be that of a typical commercial or hospital environment.
Surge IEC 61000-4-5	±1 kV line(s) to line(s)	±1 kV line(s) to line(s)	Mains power quality should be that of a typical commercial or hospital environment.
Voltage dips, short interruptions, and voltage variations on power supply input lines IEC 61000-4-11	<5% Un (>95% drop in Un) for 0,5 cycle 40% Un (60% drop in Un) for 5 cycles 70% Un (30% drop in Un) for 25 cycles <5% Un (>95% drop in Un) for 5 seconds	<5% Un (>95% drop in Un) for 0.5 cycle 40% Un (60% drop in Un) for 5 cycles 70% Un (30% drop in Un) for 25 cycles <5% Un (>95% drop in Un) for 5 seconds	Mains power quality should be that of a typical commercial or hospital environment. Marina is equipped with a battery.
Power frequency (50/60 Hz) magnetic field IEC 61000-4-8	3 A/m	3 A/m	Power frequency magnetic fields should be at levels characteristic of a typical location in a typical commercial or hospital environment.
NOTE Un is the a.c. mains voltage prior to application of the test level			

Guidance and Manufacturer's declaration-electromagnetic immunity			
The Marina is intended for use in the electromagnetic environment specified below. The customer or the user of the Marina should assure that it is used in the following environment:			
Immunity Test	IEC 60601-1-2 Test Level	Compliance Level	Electromagnetic Environment - guidance
RF Common mode/ Conducted Susceptibility IEC 61000-4-6	3 Vrms 150 kHz to 80 MHz	3 V	Portable and mobile RF communications equipment should be used no closer to any part of the Marina, including cables than the recommended separation distance calculated from the equation applicable to the frequency of the transmitter. Recommended separation distance $d = 1,2 \sqrt{P}$ $d = 1,2 \sqrt{P}$ 80 MHz to 800 MHz $d = 2,4 \sqrt{P}$ 800 MHz to 2,5 GHz
Radiated RF Electromagnetic Field IEC 61000-4-3	3 V/m 80 MHz to 2,5 GHz	3 V/m	Where P is the maximum output power rating of the transmitter in watts (W) according to the transmitter manufacturer and d is the recommended separation distance in meters (m). Field strengths from fixed RF transmitters, as determined by an electromagnetic site survey, ^a should be less than the compliance level in each frequency range. ^b Interference may occur in the vicinity of equipment marked with the following symbol: 
NOTE 1 At 80 MHz and 800 MHz, the higher frequency range applies.			
NOTE 2 These guidelines may not apply in all situations. Electromagnetic propagation is affected by absorption and reflection from structures, objects and people.			
a Field strengths from fixed transmitters, such as base stations for radio (cellular/cordless) telephones and land mobile radios, amateur radio, AM and FM radio broadcast and TV broadcast cannot be predicted theoretically with accuracy. To assess the electromagnetic environment due to fixed RF transmitters, an electromagnetic site survey should be considered. If the measured field strength in the location in which the Marina is used exceeds the applicable RF compliance level above, the Marina should be observed to verify normal operation. If abnormal performance is observed, additional measures may be necessary, such as re-orienting or relocating the Marina.			
b Over the frequency range 150 kHz to 80 MHz, field strengths should be less than 3 V/m.			

Recommended separation distance between portable and mobile RF communications equipment and the Marina			
The Marina is intended for use in the electromagnetic environment in which radiated RF disturbances are controlled. The customer or the user of the Marina can help prevent electromagnetic interference by maintaining a minimum distance between portable and mobile RF communications equipment (transmitters) and the Marina as recommended below, according to the maximum output power of the communications equipment.			
Rated maximum output power of transmitter W	Separation distance according to frequency of transmitter m		
	150 kHz to 80 MHz $d = 1,2 \sqrt{P}$	80 MHz to 800 MHz $d = 1,2 \sqrt{P}$	800 MHz to 2,5 GHz $d = 2,4 \sqrt{P}$
0,01	0,12	0,12	0,24
0,1	0,38	0,38	0,76
1	1,2	1,2	2,4
10	3,8	3,8	7,6
100	12	12	24
For transmitters rated at a maximum output power not listed above, the recommended separation distance d in meters (m) can be estimated using the equation applicable to the frequency of the transmitter, where P is the maximum output power rating of the transmitter in watt (W) according to the transmitter manufacturer.			
NOTE 1 At 80 MHz and 800 MHz, the separation distance for the higher frequency range applies.			
NOTE 2 These guidelines may not apply in all situations. Electromagnetic propagation is affected by absorption and reflection from structures, objects and people.			

