



By Ormesa

U. S. Suggested Retail Price List
Sep-19

Quote: _____

P.O. _____

Bill To

Dealer: _____ Contact: _____

Address: _____

City: _____ State: _____ Zip: _____

Phone: _____ Fax: _____

Email: _____ Mark For: _____

Ship To **Same as Bill To** _____

Dealer: _____ Contact: _____

Address: _____

City: _____ State: _____ Zip: _____

Phone: _____ Fax: _____

Email: _____ Mark For: _____

New Bug Features and Specifications

- **Seat** - can be used as a floor sitter, width and depth adjustable by 4" in each direction, small can be forward or reverse facing
- **Tilt** - incorporated in the seat 40°, easily adjusts with levers located on seat back
- **Headrest** - incorporated into the backrest so that the child always has a support
- **Backrest** - slightly contoured, can recline 35° (hinge coincides with child's center of gravity) height adjustable 4" with slots for accessories
- **Elevating Legrest** - push button adjustable, footrest is height and angle adjustable
- **Base** - black powder coated aluminum with an angle adjustable push-handle

New BUG Seat - includes: seat back, seat pan, tilt, and recline.

Part Number	Description	Price	HCPCS
_____ NBS	New BUG Small	\$1,100.00	E1399
_____ NBS3	New BUG Medium	\$1,200.00	E1399
_____ NBREC	Reclining Backrest required	\$400.00	E1014



Outdoor Base Options

Part Number	Description	Price	HCPCS
_____ NB869-1	4-Wheel Base Sm	\$1,900.00	E1238
_____ NB869-3	4-Wheel Base Md	\$2,000.00	E1238
_____ 891	Set of Tie Down Hooks (Only available with NB869)	\$275.00	K0108



Intended for forward-facing transport of the pushchair in a motor vehicle. Conforms with ISO 7176/19 and ANSI RESNA WC/19.









_____ NB856-1	Hi-Low Feeding Base Sm	\$1,850.00	E1399
_____ NB856-3	Hi-Low Feeding Base Md	\$1,950.00	E1399
_____ NB850-1	Floor Base Sm	\$660.00	E1399
_____ NB850-3	Floor Base Md	\$710.00	E1399





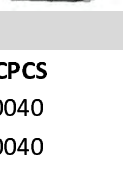

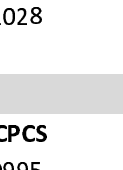
Client:



PO:

New Bug















Colors		This price is only valid when purchasing a seat unit.			
Part Number	Description	Price			
NBLP-1/NBLP-3	Light Grey with Pink and Teal accent	\$10.00			
NBDP-1/NBDP-3	Dark Grey with Pink and Teal accent	\$10.00			
NBLG-1/NBLG-3	Light Grey with Green and Teal accent	\$10.00			
NBDG-1/NBDG-3	Dark Grey with Green and Teal accent	\$10.00			

Footrest Options		Footplate and Hardware Required Parts		
Part Number	Description	Price	HCPCS	
NB810-1	Angle Adjustable Flip Up Footplate Sm <small>requires NB810-HW</small>	\$125.00	K0040	
NB810-3	Angle Adjustable Flip Up Footplate Md <small>requires NB810-HW</small>	\$125.00	K0040	
NB810-HW	Footplate Hardware and Adjustment Tool	\$125.00	E1028	











Footrest Accessories				
Part Number	Description	Price	HCPCS	
NB811	Calf Strap	\$50.00	E0995	
827	Foot Strap 8-11"	\$70.00	E0951	
827A	Foot Strap 11-14"	\$80.00	E0951	
NB892-1/2	Padded Foot Plate Sm	\$100.00	K0108	
NB892-3/4	Padded Foot Plate Md	\$100.00	K0108	

Hip Guide Options		Hip Guides and Hardware Required Parts		
Part Number	Description	Price	HCPCS	
<u>Size Small</u>				
NB815-L-1	Left Hip Guide width & angle adj armrest & upholstery <small>requires NB815-HW</small>	\$60.00	E0956	
NB815-R-1	Right Hip Guide width & angle adj armrest & upholstery <small>requires NB815-HW</small>	\$60.00	E0956	
NB815-L-HW/R-HW	Hardware for Hip Guide and Arm Rest	\$60.00	E1028	
<u>Size Medium</u>				
NB815-L-3	Left Hip Guide width & angle adj armrest & upholstery <small>requires NB815-HW</small>	\$60.00	E0956	
NB815-R-3	Right Hip Guide width & angle adj armrest & upholstery <small>requires NB815-HW</small>	\$60.00	E0956	
NB815-L-HW/R-HW	Hardware for Hip Guide and Arm Rest	\$60.00	E1028	

Positioning Options

Part Number	Description	Price	HCPCS	
817-1	Leg Straps Sm	\$135.00	K0038	
817-3	Leg Straps Md	\$135.00	K0038	
NB920-1/2	4 Point Pelvic Belt Sm	\$195.00	E0978	
NB920-3/4	4 Point Pelvic Belt Md	\$195.00	E0978	
894-1	45° Pelvic Belt Sm	\$95.00	E0978	
894-3	45° Pelvic Belt Md	\$95.00	E0978	
906-1	5 Point Harness Sm	\$130.00	E0960	
906-4	5 Point Harness Md	\$130.00	E0960	
NB903-1	5 Point Vest Harness Sm	\$295.00	E0960	
NB903-3	5 Point Vest Harness Md	\$295.00	E0960	
853	Vest Harness Sm	\$175.00	E0960	
853-3	Vest Harness Md	\$175.00	E0960	
NB868-1	Wrappable and Flexible Trunk Supports Sm height and depth adjustable	\$430.00	E0956	
NB868-3	Wrappable and Flexible Truck Supports Md height and depth adjustable	\$430.00	E0956	
HB435-S32-B1	Body Point X Small 4 Point Hip Belt WC19 Compliant - size 9" - 11"	\$140.00	E0978	
SH260XS-B1	Body Point X Small Pivot Fit Shoulder Harness WC19 Compliant - size 9" - 11"	\$175.00	E0960	
NB838-1	Lateral Pads Sm <small>requires NB838-HW</small>	\$100.00	E0956	
NB838-3	Lateral Pads Md <small>requires NB838-HW</small>	\$100.00	E0956	
NB838-HW	Lateral Hardware height and depth adjustable	\$150.00	E1028	
NB834-1	Padded Abduction Block with Hardware Sm depth adjustable	\$140.00	E0957	
NB834-3	Padded Abduction Block with Hardware Md depth adjustable	\$140.00	E0957	
NB852-1	Headrest w/ Parietal Supports Sm fixed, height adjustable	\$290.00	E0955	
NB852-3	Headrest w/ Parietal Supports Md fixed, height adjustable	\$290.00	E0955	
NB863-1	Headrest w/ Occipital-Parietal Supports Sm <small>requires NB863-HW</small>	\$290.00	E0955	
NB863-3	Headrest w/ Occipital-Parietal Supports Md <small>requires NB863-HW</small>	\$290.00	E0955	
NB863-HW	Multi Axis Hardware - angle and depth adjustable	\$265.00	E1028	
NB942-1	Ergonomic Headrest Sm <small>requires NB942-HW</small>	\$290.00	E0955	
NB942-3	Ergonomic Headrest Md <small>requires NB942-HW</small>	\$290.00	E0955	
NB942-HW	Multi Axis Hardware - angle and depth adjustable	\$170.00	E1028	

Accessories

Part Number	Description	Price	HCPCS	
NB819-1	Black Retractable Canopy Sm front and rear view window requires NB819-HW	\$295.00	K0108	
NB819-3	Black Retractable Canopy Md front and rear view window requires NB819-HW	\$295.00	K0108	
NB819-HW	Canopy Hardware	\$95.00	E1028	
NB825-1	Black Rain Cover Sm requires NB819	\$140.00	K0108	
NB825-3	Black Rain Cover Md requires NB819	\$140.00	K0108	
NB824-1	Transparent Table with Edge & Hollow Sm requires NB824-HW	\$240.00	E0950	
NB824-3	Transparent Table with Edge & Hollow Md requires NB824-HW	\$240.00	E0950	
NB824-HW	Adjustable and Removable Table Hardware	\$100.00	E1028	
NB839-1	Front Handle Sm	\$200.00	K0108	
NB839-3	Front Handle Md	\$200.00	K0108	
818	Black Thermal Cover Sm	\$365.00	K0108	
818-3	Black Thermal Cover Md	\$365.00	K0108	
858	Medical Necessity Basket Sm Not compatible with NB927 or NB935	\$125.00	K0108	
858-3	Medical Necessity Basket Md Not compatible with NB927 or NB935	\$125.00	K0108	
NB927-1	Vent Tray Sm Not compatible with 858	\$650.00	E1029	
NB927-3	Vent Tray Md Not compatible with 858	\$650.00	E1029	
922	Water Bottle Holder	\$45.00	K0108	
NB935	Oxygen Bottle Holder Sm Not compatible with 858	\$250.00	E2208	
NB935-3	Oxygen Bottle Holder Md Not compatible with 858	\$250.00	E2208	
NB-IV	IV Pole	\$495.00	K0108	

Client:

PO:

New Bug

Client Measurements:

A Back height: _____ F Lower leg length: _____
 B Chest depth: _____ G Head height: _____
 C Chest width: _____ H Arm height: _____
 D Seat depth: _____ Age: _____
 E Seat width: _____ Weight: _____

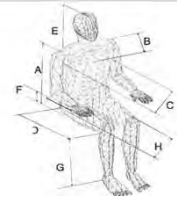

DIMENSIONS

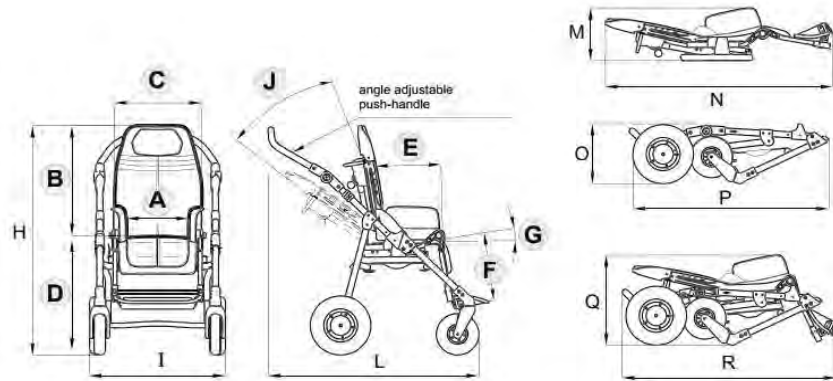

Measurements in Inches

Seat & Bases	MAX LOAD	A	B	C	D	E	F	G	J	H	I	L	M	N	O	P	Q	R	FRAME WEIGHT	SEAT WEIGHT	TOTAL WEIGHT
Sm 4 wheel	77 lbs	8 - 11	20 - 24	14.5	20.5	8 - 12	5 - 12	0° - 35°	35°	41 - 45	22.5	26 - 37	11.5	34.5	11.5	32	17	32	21	19	40
Md 4 wheel	99 lbs	10 - 14	24 - 30	17	21.5	12 - 16	12 - 16	0° - 25°	40°	45 - 51	24.5	32 - 42	13.5	44	14	36	20.5	37	23	25	48
Sm 3 wheel	77 lbs	8 - 11	20 - 24	14.5	20.5	8 - 12	5 - 12	0° - 35°	35°	41 - 45	22.5	26 - 37	11.5	34.5	16	31	N/A	N/A	23	19	42
Md 3 wheel	99 lbs	10 - 14	24 - 30	17	21.5	12 - 16	12 - 16	0° - 25°	40°	45 - 51	24.5	32 - 42	13.5	44	16	38	N/A	N/A	25	25	50
Sm Hi/Low	77 lbs	8 - 11	20 - 24	14.5	18.5 - 29	8 - 12	5 - 12	0° - 35°	35°	39 - 53	22	14 - 24	31	16	9	N/A	N/A	N/A	32	19	51
Md Hi/Low	99 lbs	10 - 14	24 - 30	17	18.5 - 29	12 - 16	12 - 16	0° - 25°	40°	42 - 58	24	14 - 24	33	18	13	N/A	N/A	N/A	34	25	59
Sm floor base	77 lbs	8 - 11	20 - 24	14.5	6.5	8 - 12	5 - 12	0° - 35°	35°	27 - 31	18	2.5	24	16	9	N/A	N/A	N/A	10	19	29
Md floor base	99 lbs	10 - 14	24 - 30	17	6.5	12 - 16	12 - 16	0° - 25°	40°	30 - 36	20	2.5	25	18	11	N/A	N/A	N/A	12	25	37

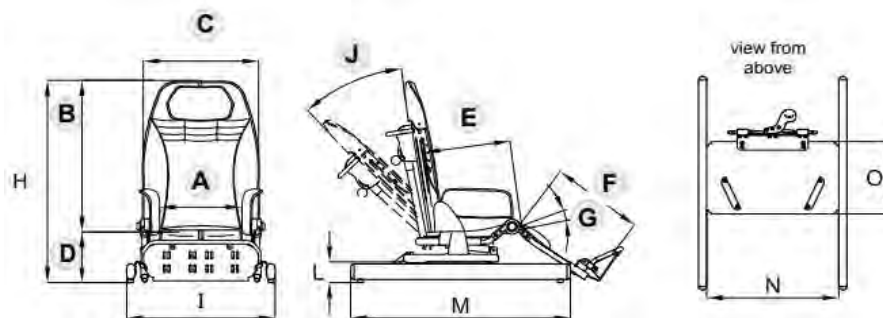
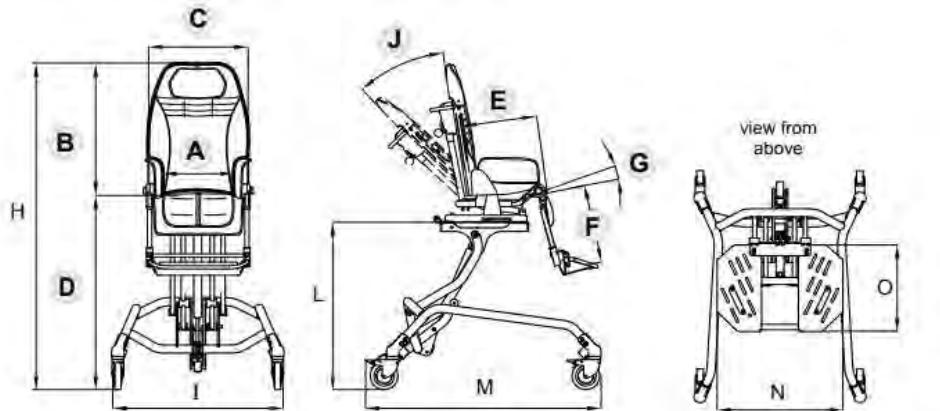

Note: All specification and prices are subject to change without notice. Prices listed are only valid if ordering with a base. The HCPCS codes provided are not intended to be billing or legal advice, rather Innovation In Motion's interpretation of the code definitions. Use of the codes provided does not ensure coverage or payment for the item. For coverage information, verify the policy of the appropriate payer.