

HEADPOD CERTIFICATION COURSE



ENGLISH

Headpod[®]
PATENTED Keeps the head up

INDEX

**Welcome to the Headpod Certification Course.
Please, read the instructions carefully,
and pay special attention to the Chapter 4:
Difficult cases and maneuvers.**

1	Introduction and Fundamentals	4
2	Instruction Manual: Indications and Recommendations	8
3	Components: Kit Standard, Kit Mini, Kit Pro and Accessories	18
4	Special uses: Headpod in walkers and cars. Difficult cases and maneuvers. Detachable backup	20
5	Protocol for use. Goals, Benefits, and Side Effects	24
6	Research	30

CHAPTER 1

INTRODUCTION AND FUNDAMENTALS.

INTRODUCTION

Standing on two feet and the consequent elevation of the head was a development of thousands of millions of years and perhaps the most important milestone in the development of human beings. It is the moment when man began to dominate the planet. The anatomy completely adapted to this immense change, which is why when a person cannot hold their head upright the whole motor and sensory balance is affected, and thousands of millions of years of evolution remain unrewarded.

To date, all head support systems for those with bad head control are based on placing restrictions or limits on the movement of the same, as well as reclining the support in order to prevent the head from falling in a lateral or anterior flexion. This head restriction leads to inactivity of the muscles of the neck just as happens in people who use a “collar” to hold it. There are many devices which are based on this blocking mechanism such as i2i systems, Headmaster collar, etc.

The reason for reclining the support backwards is to avoid the head-fall in patients with hypotonia by retarding the center of gravity thereof to a point that is offset by the upward normal force exerted by the cervical spine, avoiding in this way that said center of gravity is ahead of this force and thereby producing anterior head flexion.



FUNDAMENTALS OF HEADPOD

Before being able to discover Headpod we had to define the main concepts involved in the loss of head control that we wanted to solve, and there were three: 1st head weight and thus its falling, 2nd the angle of the head with the neck, and 3rd head rotation. To get a proper solution to the loss of head control we ought to cancel out the 1st and 2nd concepts and facilitate the 3rd.

In this respect we designed an offloading device that managed to vertically align the head with the torso. The way to achieve this was to consider the head being formed of two circumferences and surrounding the forehead (a) and the lower occipital part of the head (b) by a flexible element that gathers the strains and projects them upwards through a rigid arc and a flexible and elastic rubber strap (c), which itself finally hangs from the suspension arm (d).

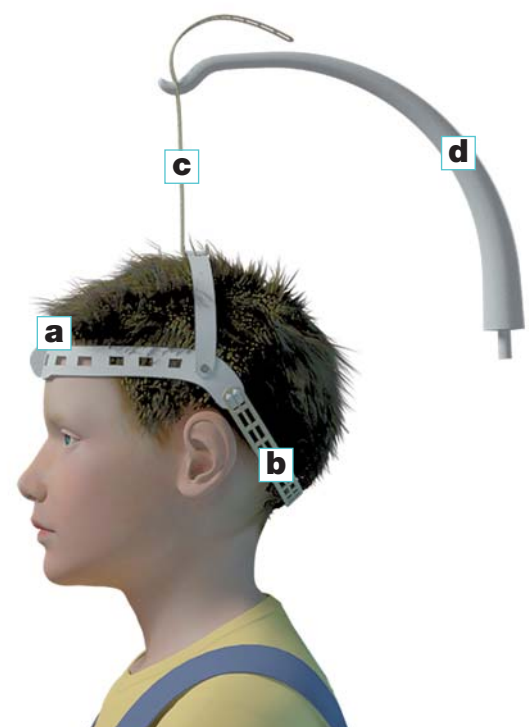

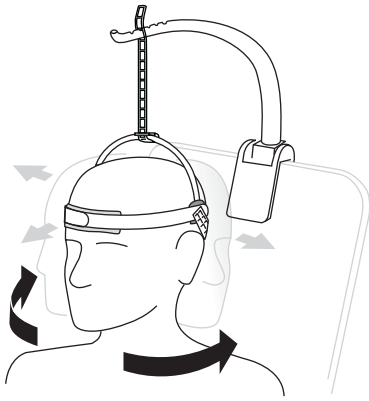

The more coaxial the axis of the neck with the axis of the rubber strap, the better this allows the head to rotate. Owing to the fact that said rubber strap has a lateral displacement capacity of “pendulum” type, lateral and anterior-posterior movements can also be carried out within a determined range limited by the length of said pendulum. A small distance between the head and the suspension arm reduces the length of the pendulum and therefore its lateral displacement capacity. The only movements that are really restricted are anterior and lateral flexion of the head that is to say the “fall” of it. All this makes a big difference with regards to all current fixed restraint /support systems.

In summary, the two main actions of Headpod are:

1. Prevent head “fall”.
2. Facilitate its rotation.

Headpod produces a realignment of the head and neck with the backbone (cervical column), without at any time producing traction on these structures, thereby achieving a situation in which the backbone supports the majority of the weight and allowing the neck musculature to work in a final adjustment to thereby achieve correct vertical positioning of the head. We all know examples of how a weight is easier to carry the closer we position it to the vicinity of the spinal column axis.



In a vertical positioning of the head, or almost vertical, the entire sensory, visual and motor balance is performed in a more physiological manner with rotation being carried out in a more complete manner, and with the muscle activity being both smooth but maintained, and with the action of the neck muscles as well as those of the proprioceptive sensory system that accompanies them developing itself in a continuous manner.

In people with cerebral palsy it often happens that there is a loss of the precision with which the orders generated in the brain are transmitted to the corresponding muscle fibres. The impulses generated in the brain to keep the head upright are not projected on specific muscles for that action, but rather on multiple muscles of the upper trunk and upper extremities, including activating agonists and antagonists at the same time. This supposes a hypertonia and a debilitating excess of effort that cannot be maintained continuously, as well as a very significant lack in the precision of voluntary movements.

Through using Headpod we obtain a situation where the head doesn't fall towards extreme positions and thereby keeping it upright requires less effort, so the movements of the upper torso and upper extremities are made with greater precision and less muscular tone. Usually the patient will need to adopt his final vertical position whilst Headpod helps unburden his head on the cervical and dorsal column, and in so doing he will develop a continuous working of the neck muscles to help improve his posture in the future.

Via the aforementioned one can see that Headpod is based on achieving a partial unloading of the head weight, thus avoiding having to withstand the added weight of approximately 5 kg that the head and neck generally suppose, and this is why it is not indicated for use in children engaged in neck movements with high muscle tone, including strong dystonias and spasticity of the same, as in these cases Headpod will have to work at a higher tension than that for which it was originally intended. However, in some of these children we can use it during the consultation to help develop different skills and abilities or exercises, or it could even be recommended for some specific moments within the normal life of the child.

The Dynamic Suspension of the Head is a concept developed by Siesta Systems, S.A. which aims to keep the head upright in a vertical position so that it can perform movements independent to those which the upper part of the torso make. In a person with disabilities it will bring about movements of the head different from those carried out by the upper part of the body trunk. If we use it in a vehicle with self motion, the dynamic clamping concept implies that the head can encompass its displacements to those that the vehicle is performing, whilst leaving some freedom to move the head, and making a restriction of its lateral displacement in a progressive fashion from one given moment which is related to the length of the pendulum, as noted previously.

CHAPTER 2

INSTRUCTION MANUAL.

INDICATIONS AND RECOMMEN- DATIONS

STANDARD KIT AND MINI KIT CONTENTS

Bag 1: Harness

1. Arc (x3)* / 2. Scaled rubber strap / 3. Orange pieces
4. Right frontal strap / 5. Left frontal strap / 6. Sponge padding
7. Occipital mesh (1+replacement) / 8. Replacement sponge

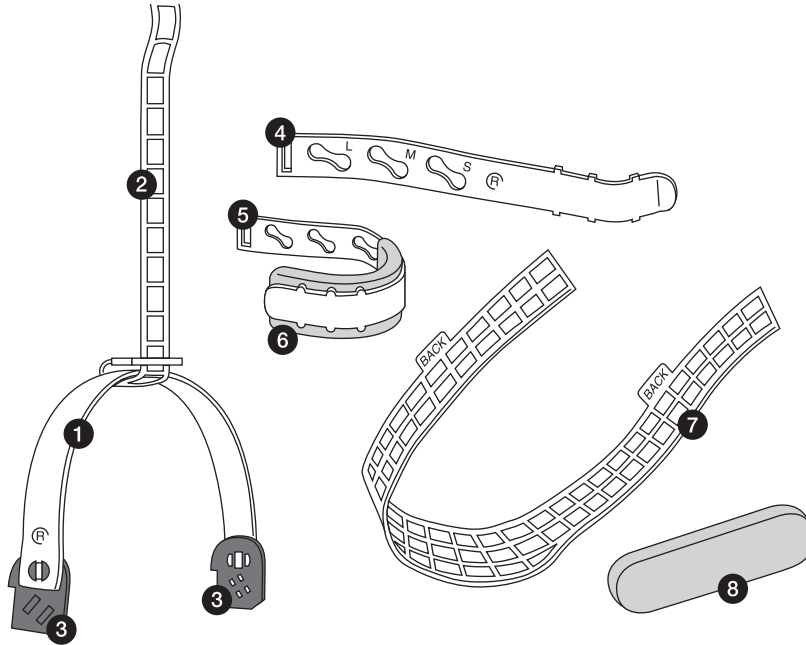

* The Headpod Kit Mini contains two arcs of smaller size instead of three bigger arcs, and a small frontal strap for narrow foreheads

Bag 2: Adaptors

10. Suspension arm / 11. Adaptor A / 12. Adaptor B
13. Asymmetric wedge (x2) / 14. Rubber spacer / 15. Adaptor C
16. Modifier of angles / 17. Metal tube / 18. Extender

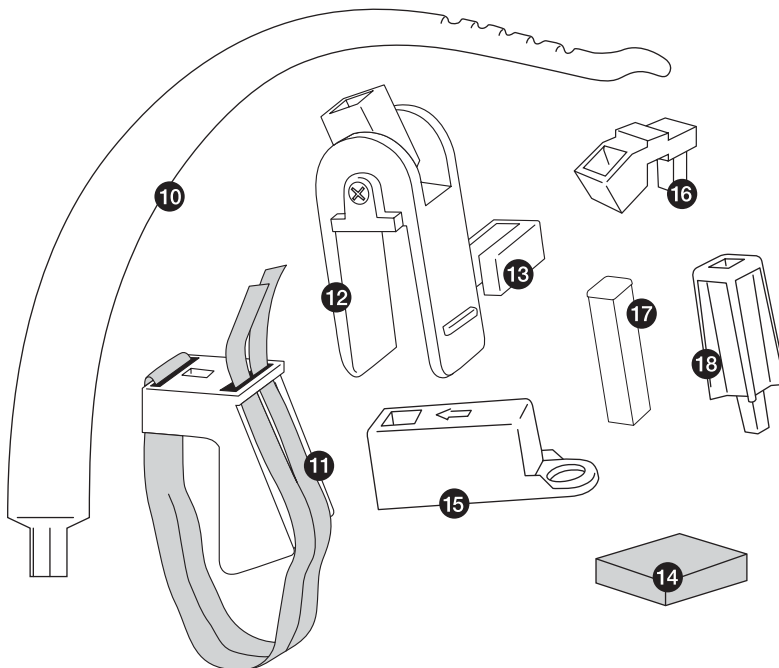

ADJUST HEADPOD BEFORE FIRST USE

Please follow the steps carefully.

Step 1. Select the Arc (1)

Open the Bag1 and choose between the arcs provided the smallest that can be put on the head without rubbing on the sides. We recommend leaving a 0.5 mm gap (0.2 inch) on both sides of the head.

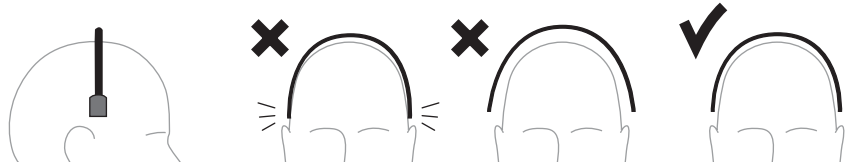

Step 2. Place the right frontal strap (4) in the arc

Attach the right frontal strap (4), marked with an R, in the matching right orange piece (3) of the selected arc (1). To ensure that it is properly seated, pay attention that all the pieces have the letter R facing you.

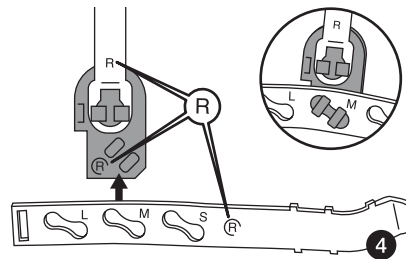

It is important to insert the two protuberances of the orange piece in a single orifice in the form of “eight” situated in the frontal strap, as shown in the figure. As a guide, use the hole **M**, unless the head is large (**L**) or extremely small (**S**).

Step 3. Place the left frontal strap (5) in the arc

Now turn the arc through 180 degrees and place the left frontal strap (5) on the left side of the arc. If it is an adult size head use the hole in the form of “eight” **L**, if that of a child use **M**, and if it is extremely small use **S**. To ensure that the left strap is properly seated ensure that all the pieces have the letter **L** facing you. The sponge (6) is attached to this by means of a Velcro tape.

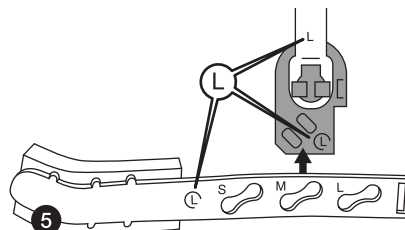

Step 4. Place the occipital mesh (7)

Assemble the occipital mesh on both sides of the arc. For this, use the same two orange protruding parts where the frontal straps are already attached. As a guide, if the head is of an adult use the third row of paired holes. If the head is of a child, use the fourth row, and if the head is extremely small use the sixth or the seventh row.

Be sure that the word BACK is facing the back as shown. To verify that your Headpod is mounted correctly, orient the device as shown in the figure below and compare the position of the pieces to see if it is correct.

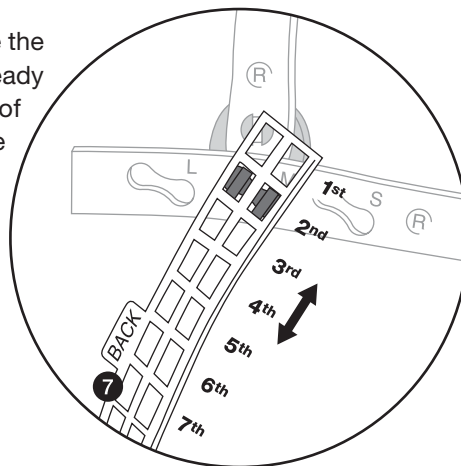
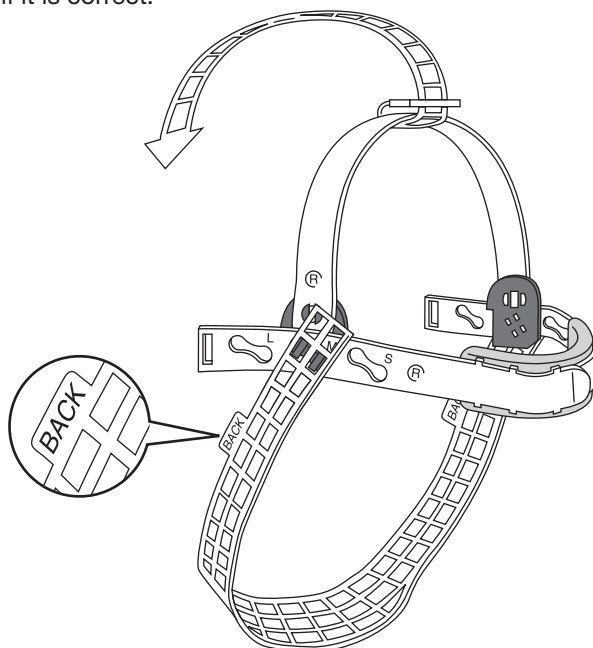

Step 5. Install the adaptor

Open the Bag 2. Given the wide range of chairs on the market, we provide three different adaptors (11,12,15). Below we describe how each one of them works so you can pick the one that best suits your chair.

Adaptor A: for wheelchairs with headrest

If the seat has a headrest use this adaptor (11) as shown in the figure. Firmly tighten the straps upward before adhering to the Velcro so that the upper surface of the adaptor remains horizontal and stable when in use. We recommend leaving the headrest adaptor permanently in place, to extend the life of the Velcro strap.

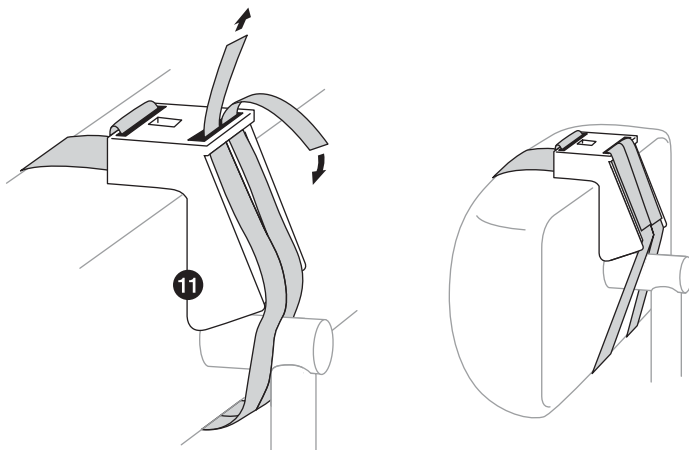

Adaptor B: for chairs with a rigid back

Use this adaptor (12) if your chair does not have headrest but a rigid backing. Place the back of the chair in a nearly vertical position (approx. 10° inclination backward). Usually put in the forwards position the face A (Side A 10°) of the adaptor. If the seat is reclined backward more than 10 degrees the suspension arm will be tilted upward instead of horizontally. To avoid this, try using the B-side (side B 20°) forwards. To avoid a lateral slippage of the adaptor, we recommend attaching it firmly and directly in contact with the hard surface of the back of the chair, and not over its external surface.

It has two asymmetric wedges (13) for a tight fit on the back. If they prove to be insufficient, because the back of the chair is a thin metal plate, remove the upper part of the upholstery, and use the two thick sides of the wedges adding thereafter the rubber spacer provided (14).

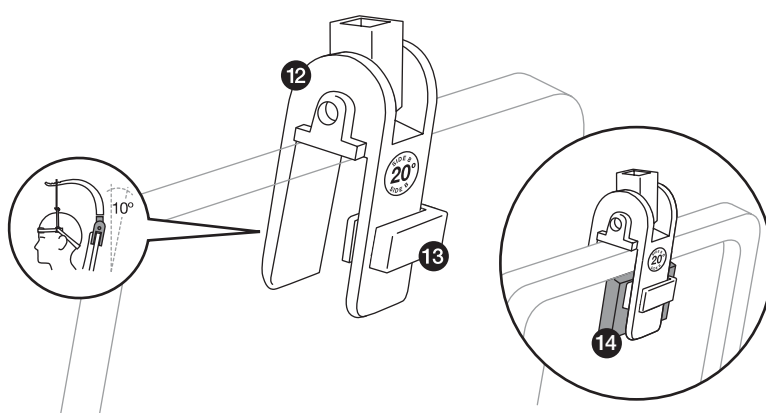
**Adaptor C: universal**

This adaptor (15) has been designed to be used when none of the previous adaptors can be firmly fixed. A square metallic tube 15 x 15 mm, should be previously installed in the chair as close as possible to the rear edge of the back or headrest and protruding between 25 and 30 mm above. The supplied metal tube (17) has a shape and length that may not coincide with your wheelchair needs. Ask your orthopedic technician or assistive tech provider about installing this piece (not included in the price of Headpod).

Select one of the two positional options of the adaptor to be inserted on the tube. The adaptor should be approximately the height of the upper edge of the user's head.

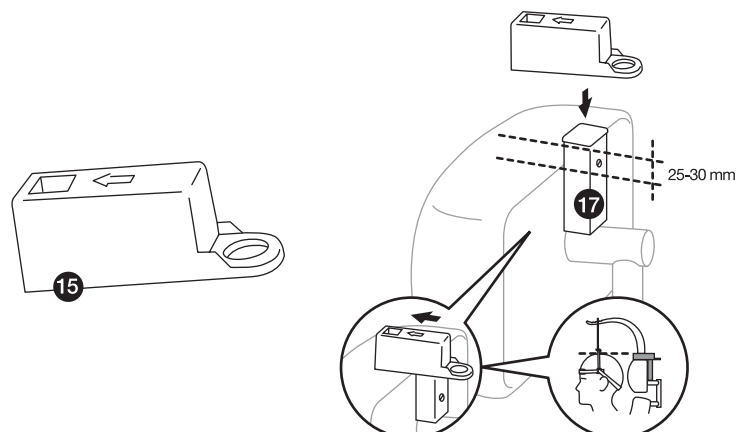

Step 6. Place the suspension arm

The correct position of the suspension arm is more or less horizontal.

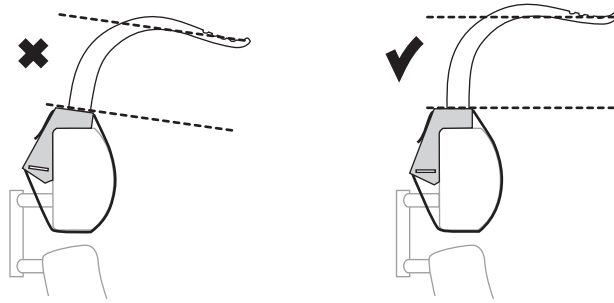

IMPORTANT

1. The adaptor must be firmly secured so it does not rotate the suspension arm whilst being used.
2. Whatever the chosen adaptor is, it ought to be located as close to the back of the head as possible, so that the suspension arm reaches the front of the head as shown.

If it is displaced upwards, insert the angle modifier (16) in the adaptor to improve the horizontality.

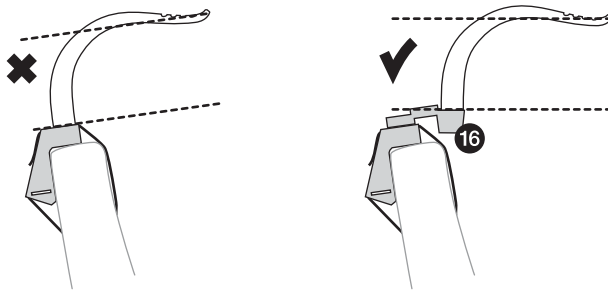

Use the extender (18) only in cases where the suspension arm is too close to the top of the head, that is to say when you are using any of the last three steps of the scaled rubber strap.

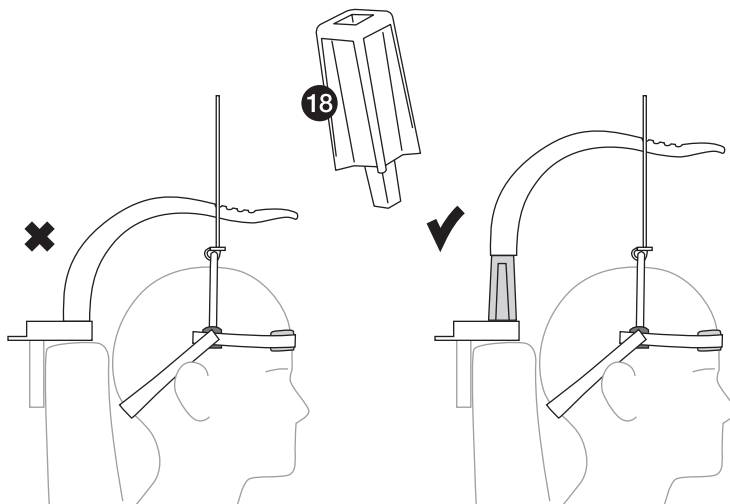

DAILY USE OF HEADPOD

The steps above are only required before first use. For daily Headpod use, STAND IN FRONT OF THE USER and follow these steps:

1 Close the Velcro across the forehead.

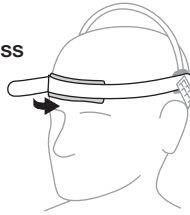

2 Move the occipital mesh downward as close to the ears as possible without going on top of them.

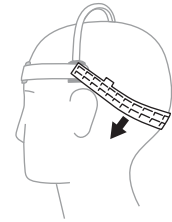

3 Be sure the arc is parallel to the user's forehead.

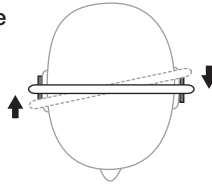

4 Re-tighten the Velcro strap if loose.

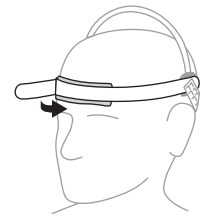

5 While holding the chin with one hand, hang the scaled rubber strap on the suspension arm at a height that keeps the head in a vertical position.

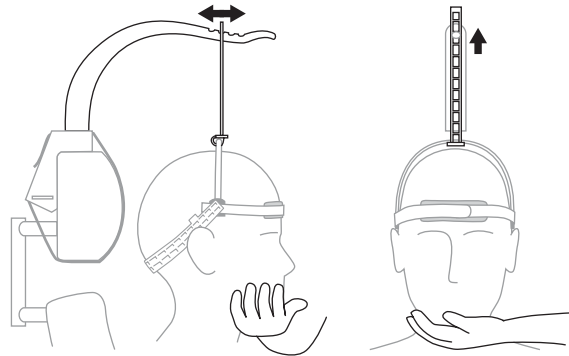

The head should not lean forward (hyper flexion) or backward (hyper extension). To avoid this, move the scaled rubber strap along the suspension arm as indicated in the illustration by the horizontal arrow to achieve the desired position of the head. Using the front part of the suspension arm the user will have a better ability to look down, and vice versa.

If the head falls to either side (lateral flexion), hold the chin again and move the scaled rubber strap up another rung, as indicated in the illustration by the vertical arrow. By doing so, the correct position of the head can be achieved.

Important

Verify that after having positioned the Headpod, the orange pieces (3) of the arc are about one centimeter (1/2 inch) in front of both ears, as shown in dashed line A. If not, select another row of paired holes on both sides of the occipital mesh (7) to acquire this position.

Finally, make sure the sponge has been centered on the forehead. Otherwise, modify the position of the left frontal strap selecting a hole in the form of an “eight” different from that previously used.

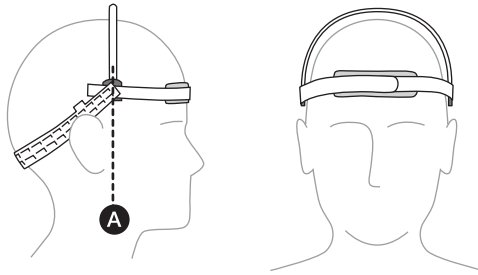

FOR WHOM IS HEADPOD INDICATED



Headpod is the best solution for children between 2 and 12 years unable to sustain the weight of their own head owing to weak neck muscles (low muscle tone). This happens for example in some types of cerebral palsy and any illness or syndrome causing hypotonia in the neck muscles.

Being a dynamic system, the result of Headpod depends on several factors, and that is why in children over 12 years, and especially adults, the success rate decreases by the greater weight of the head and deformities or abnormalities in the position to be developed over time. In these cases we recommend the patient to be evaluated previously by a professional therapist trained in the use of Headpod.



It is not indicated for people with Amyotrophic Lateral Sclerosis (ALS) owing to the severe dysphagia that usually present. It is nor recommended for use in children or adults with a great deal of extensor tone, tendency to hyper extension of the neck or trunk, or those presenting musculoskeletal deformities such as cyphosis, scoliosis or severe contractures of the neck muscles.

No known side effects have been detected from the use of Headpod.

RECOMMENDATIONS FOR USE

- To prevent hyper extension of the neck place the back in a nearly vertical position (approx. 10° inclination backward), and move the scaled rubber strap along the suspension arm. If hyper extension persists place a small cushion behind the head to avoid neck extension.

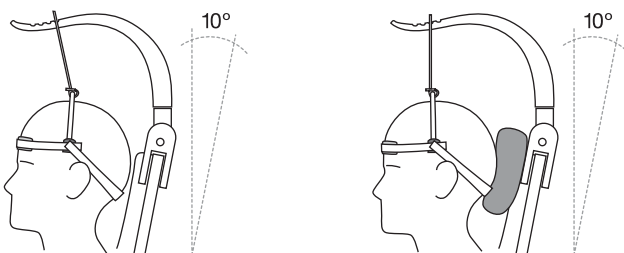

- Always use a harness to hold the torso properly upright. Use when ever possible a four point clamping harness.

- If the user has long hair, we recommend collecting it in a “bun” and situating the occipital mesh below it.
- Start out by using Headpod during meals and during rest periods when there are only few people around. Avoid stress situations that may make the user nervous.
- The user may initially show resistance to the new head position since they may be accustomed to poor posture. In these cases, several days of adaptation may be needed.
- Not recommended for daily use in excess of 6-8 hours, except in children with severe hypotonia, who clearly benefit from extended utilization.
- Some people, especially users with dermatitis, may have increased sensitivity to pressure by the device on the forehead. Reduce the time of use if red marks from wear do not disappear an hour after use.
- Because the Headpod can move if incorrectly fitted, do not leave the user unattended, especially if the user is a person who is unable to communicate verbally.
- In adults: we recommend reclining the chair back a little bit, and to use Headpod for limited periods of 30-60 minutes like mealtime, computer activities or transportation.
- If the suspension arm finishes up being too high, you can join two rubber straps together to reach where the user’s head is.

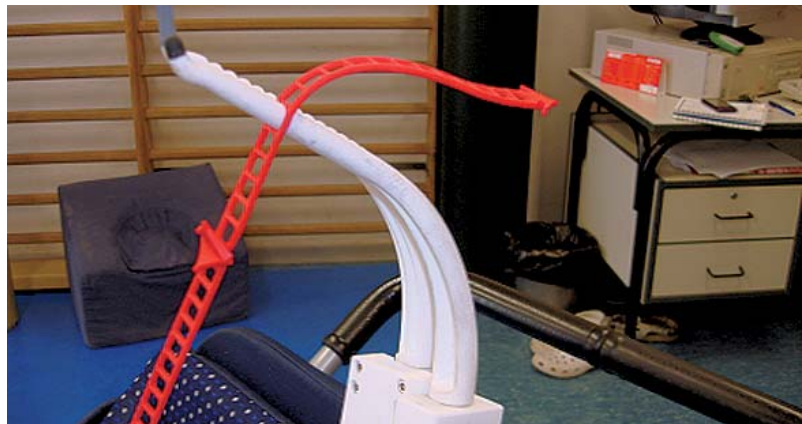

- In cases in which the suspension arm is not substantially horizontal, you may use the angle modifier in order to correct the tilt. This is often necessary in Tumble Forms chairs, in standers, in walkers, or in any chair where the adapter suffers some degree of rotation.



- To put away the suspension arm at times when it is not in use, one can insert it into the hole found in the adaptor.

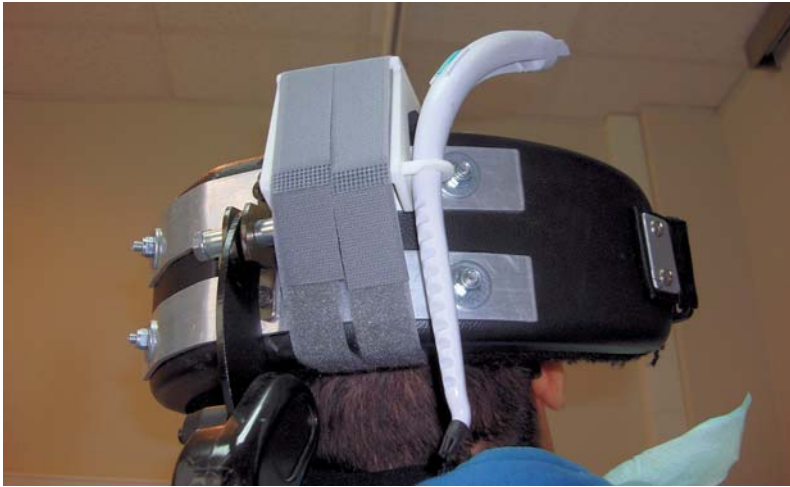

PLEASE REMEMBER

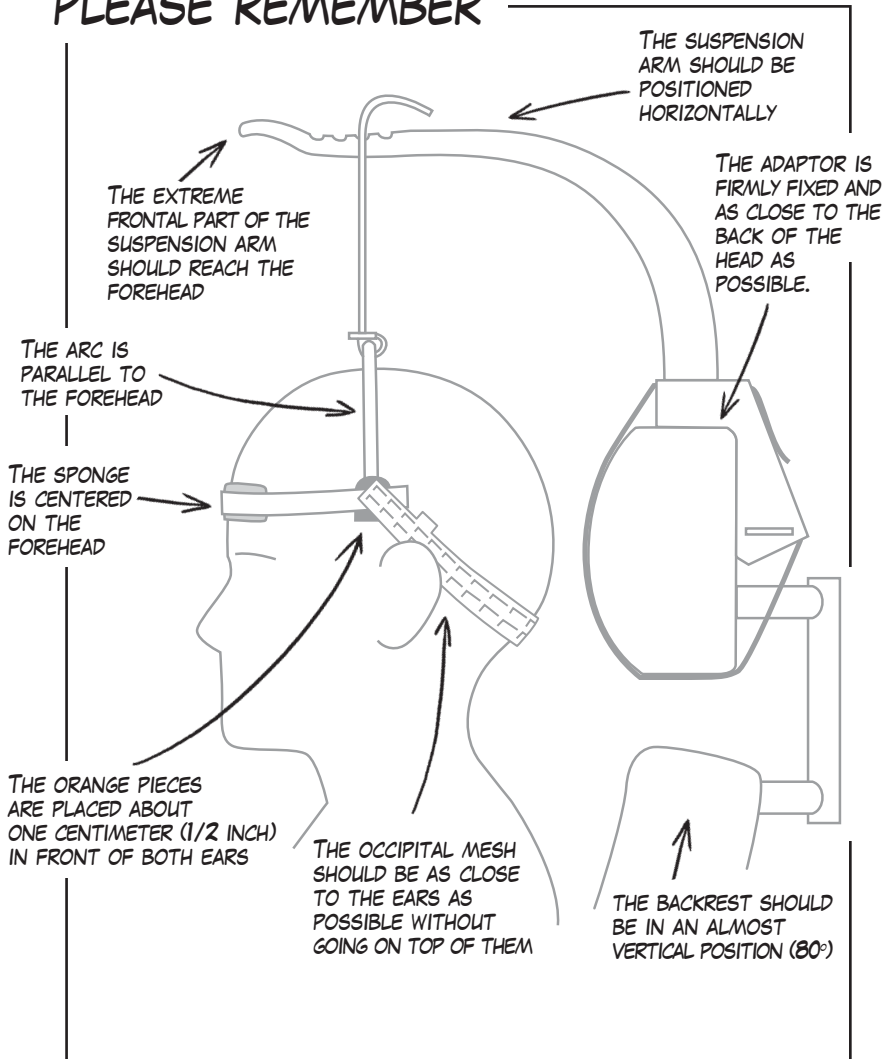

CHAPTER 3

COMPONENTS:

KIT STANDARD

KIT MINI

KIT PRO

ACCESSORIES

HEADPOD KIT STANDARD

The Headpod Kit Standard (**ref. HP101**) contains a valid Headpod device for all cranial circumferences above 45 cm (17,5 inch.), and three adapters to attach Headpod to most wheelchairs available on the market. Contains three arcs: one large (black), one intermediate (gray), and a small one (green).

HEADPOD KIT MINI

The Headpod Kit Mini (**ref. HP102**) contains a valid device for very small head sizes, less than 45 cm (17,5 inch.), and three adapters for attaching Headpod to most wheelchairs available on the market. It contains two arcs: one small (green), and a mini-arc (maroon) Includes a frontal strap for narrow foreheads.

HEADPOD KIT PRO

The Headpod Kit Pro (**ref. HP103**) has all the components supplied in the Kit Standard and the Kit Mini, and also includes an anti-slip up set for difficult cases where Headpod detaches easily, which includes a chin strap and a occipital strap.

ACCESSORIES

Accessories not supplied in the Headpod Kit Standard:

- Set Mini (**ref. HP301**): for very small heads, is a bag that contains a very small arc and a mini-headband for narrow foreheads.
- Anti-slip up set (**ref. HP302**): is a bag that contains an occipital fastening strap and a chin fastening strap for adaptation in difficult cases.
- Set of 12 sponges (**ref. HP304**): contains 12 spare sponges of 15 mm thickness.
- Mini-cap (**ref. HP303**): visor specially designed to improve the aesthetic appearance without diminishing the user's visual field.
- Adapter for conventional wheelchairs (**ref. HP404**): Bridge shaped metal adapter for fixing Headpod to a conventional wheelchair.
- Made to measure arcs: tell us the size of the arc that you need and we will make it for you.

Accessories already supplied in the Headpod Kit Standard:

- Adapter A for chair with headrest (**ref. HP401**): Adapter for use in wheelchairs with headrest
- Adapter B for stiff-backed chair (**ref. HP402**): Adapter for use in rigid back wheelchairs.
- Universal Adapter C (**ref. HP403**): universal adapter to install Headpod in any wheelchair after installation of an iron tube of 15 x 15 mm.

CHAPTER 4

SPECIAL USES:
HEADPOD IN
WALKERS AND
CARS.

DIFFICULT
CASES AND
MANEUVERS.

DETACHABLE
BACKUP.

HEADPOD IN WALKERS

We can put Headpod in a walker always provided that one has a high rigid structure from which to suspend the rubber strap. At present, some companies that manufacture walkers are developing adapters that allow for the use of Headpod. With this, the arms generally relax themselves and a better head posture is obtained together with its increased mobility. Generally for this function we use a square metal tube 15 x 15 mm on to which we place the universal adapter.



HEADPOD IN AUTOMOBILES

We are currently investigating the use of Headpod for vehicle transport. There are currently no studies that prove that using Headpod in cars can be beneficial. Using Headpod in transport vehicles will be the responsibility of the person deciding to do so.

DIFFICULT CASES

There are children who have difficulty adapting to Headpod adequately in whom it becomes detached often, for example in children with a very flat back of the head or cervical dystonia. In all these cases it is particularly important to correctly locate the chair, harness, and adapters. If however in spite of this a successful adaptation is not possible, three maneuvers with accessory straps must be taken into account because they can be helpful in the consultation sessions, and perhaps even be prescribed after teaching the family or caregivers how to do it:

Maneuver #1

This is done via a retaining chin strap. Its purpose is to hold more firmly the harness to the head in difficult cases of Headpod adaptation. It can be applied not only on chairs but also on walkers and always under caregivers supervision. For safety reasons, the strap has a controlled release point. The strap is anchored by means of two velcro small pieces permanently installed in the upper part of the occipital mesh, in front of the

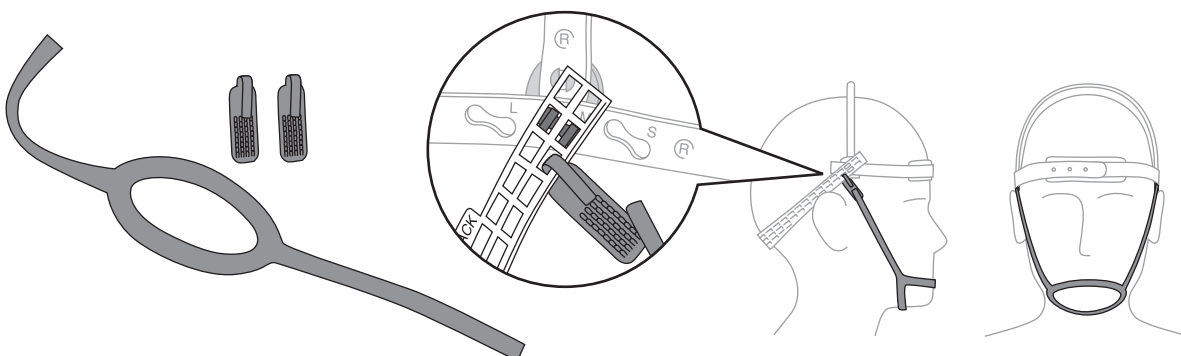

user's ear and under the orange piece, on both sides of the head. We recommend its use only for special cases or for specific times and provided the situation is supervised by a professional or caregiver already experienced in using Headpod. This strap does not alter the ability of any head movement and it is administered in the Kit Pro as well as in the set anti slip up. Not to be used during transportation.

Maneuver #2

This is performed by a strap that tightens in the occipital region. This maneuver seeks to avoid, as in maneuver 1, that the device be pushed upwards and slips off, and is used by those users who are prone to this, but in this case the chin remains free.

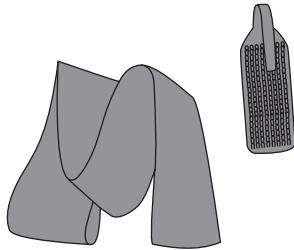

This strap has two parts. The small portion we leave installed permanently on the occipital mesh in the central hole of said mesh as shown in the pictures below. The long strip is placed over the back support of the chair. The "hook" part of the small portion, i.e. the harder surface thereof, should be located towards the back.

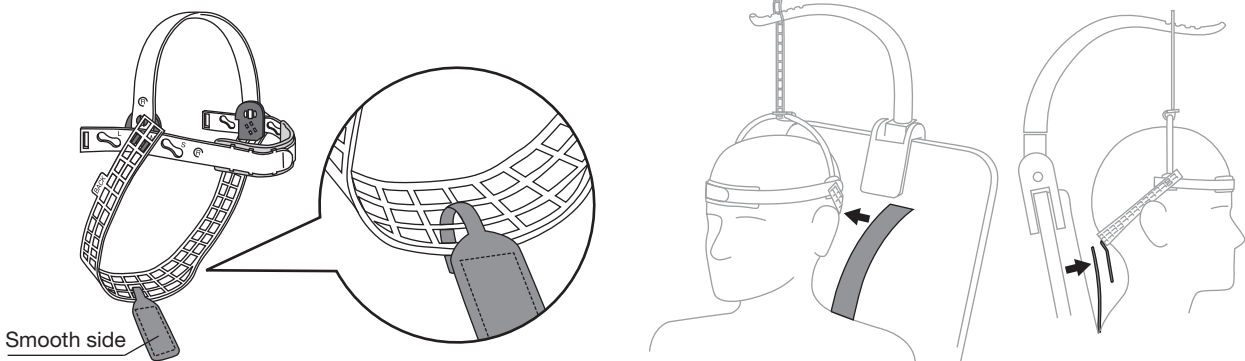

As soon as the child sits, the long ribbon gets trapped and stabilized under pressure from the user's own weight. Now, put the Headpod harness and join the two parts of the strap (hooks and loops) to prevent the harness from being moved upwards during use. We will join the two parts of the tightening occipital strap to where we want the stabilized occipital mesh to remain. This strap barely alters the ability of any head movement because it holds the occipital mesh from a central position behind. This strap is administered in the Kit Pro as well as in the Set Anti slip up.

Maneuver #3

This is performed by a standard narrow strap no wider than 10 mm. This strap is clamped in the slits located at the distal ends of the right and left frontal straps and then passes behind the suspension arm. This counteracts the tendency some users have of moving the head forward excessively and does not alter the ability of the head to rotate. An example of its use can be for eating times in the case of some adults.



DETACHABLE BACKUP: HOW TO ACQUIRE OR CREATE YOUR OWN BACKUP

We recommend therapists to have a detachable backup in the office or an anchor point. A removable backrest/support can serve in the consultation for those cases where it has not been possible to install any adapter in the backrest/support of the chair user. This will ensure the ability to carry out the assessment tests as well as the therapeutic sessions where needed.

The therapist can buy the detachable wooden backrest/support, in a standard or custom size as needed, through our online store. If instead he/she prefer to avoid this expense, and the corresponding shipping cost, one can build it on his own or order it from a DIY center nearby. We will locate the adapter in an above position as we do in stiff-backed chairs. We show you here below the two available options:

Rectangular board

The rectangular board is indicated for use in the rear part of the backrest/support of a wheelchair, a seat, or of a positioning mold and can be transported anywhere. Other places for adapting Headpod can be grab bars in a gym or a cage of type Rocher.

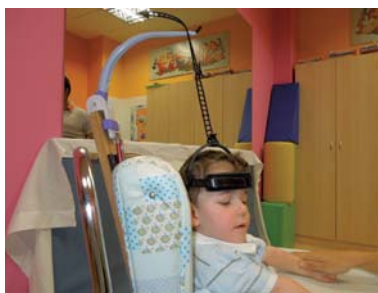
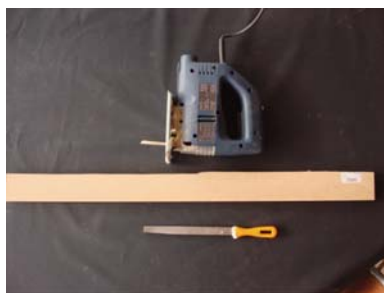

Bridge shaped board

The bridge shaped board is generally adapted in front of the backrest of a wheelchair or even of a conventional chair.



CHAPTER 5

PROTOCOL FOR USE.

GOALS, BENEFITS AND SIDE EFFECTS

PROTOCOL FOR USE: ASSESSMENT, TREATMENT AND EDUCATION

Headpod can be used as:

1. Therapeutic tool in the professional consultation.
2. A device to prescribe to the user. This is done once the usefulness of Headpod has been determined, its uses have been identified, and the family has been taught how to work with it.

In the first visit of a child with poor control of the position of his head, the practitioner will perform the Evaluation to detect if Headpod can be helpful to the patient in any of its uses: professional therapeutic activities, or home or school activities; feeding; transportation security; proprioceptive development and prevention of deformities, improved ventilation, etc.

On this same visit we will adjust Headpod to the child's head and test the resources provided with the professional kit, trying to apply it in most children with loss of head control to see if one can get some benefit from its use. The therapist should always keep in mind the three maneuvers described in this course to improve the chances of success in those most difficult cases.

To make a realistic assessment of the possibilities of Headpod, it is very important to install one of the adapters supplied in the correct manner. There are a large variety of different wheelchairs and it is for this reason that an adapter cannot be installed successfully in all of them. In the following pages we will show some examples that you can use to carry out its work process of assessment and treatment in the consultation. This lets you know if the patient is able to take advantage or not of the use of Headpod.

On the second visit we will be able to start carrying out Treatment with Headpod. In using this device in the consultation, one facilitates independence as much of the patient as that of the therapist to allow a more efficient therapy. This is due to the versatility of using Headpod in the therapist's office since by facilitating the dynamic clamping of the head the therapist can combine it with the therapies that apply and the patient progresses in more advanced stages in their therapy. We recommend making a recording of the position of the child's head in order to be able to compare the position obtained after one or two years of treatment with Headpod. The longer the period of use, the greater likelihood of improvement we get, especially if we have decided to prescribe it for home use.

Headpod can be adapted in the consultation using a wheelchair; the patient's own wheelchair, fixing an appliance to a wall, or suspending it in the Rocher cage, a trellis, or a door frame.

The head rotation will therefore be better the more coaxial that remains at the borders of the wearer's neck relative to the axis of the rubber strap. Sometimes both borders may not coincide entirely depending on the morphology of the child's head or that of the position we want to adopt. Patients with a significant musculoskeletal deformity of the neck (muscle shortening, severe cyphosis or scoliosis, etc.) are not good candidates for Headpod because we can't get a good alignment of both the neck and the cervical column.

We will place the rubber strap on the suspension arm in a front or rear position as a function of the position we wish the head to adopt. For example, placing the rubber strap in the front allows the user to adopt a more forward position of the head and makes it easier to look down than if you place it in a more backwards position where a higher position of gaze will be obtained.

We recommend making a recording of the position of the child's head at the start of treatment in order to be able to compare the evolution that has occurred after a year or more of treatment with Headpod.

The therapeutic exercises are designed to stimulate:

- Proper positioning of the head in the three planes of space/three dimensional space.
- Horizontality of the gaze.
- Correct spatial orientation of the vestibular and acoustic system.
- Stimulation of spatio-temporal orientation.
- Correct proprioceptive, enteroceptive and mecanoceptive afferent information.
- Improved postural control.
- Regulation of postural tone.
- Improved motor control. Oculo-cervical-manual co-ordination.
- Improved body schema.
- Activation of the feedback mechanism (feedback-feedforward).
- Growth stimulation.
- Sensory-motor integration.
- Activation of neuronal plasticity.

At the psychic level:

- Achieving basic needs.
- Decreased anxiety.
- Auto recognition.
- Imitation.
- Membership.
- Reward System.
- Improve attention.
- Learning.

At the social level:

- Integration into family life.
- Offloading the work of the carer.
- Security in the surveillance.
- Relationship with other children.
- Integration in workgroups.

Practices in children

The difficulty of standardization of the exercise in children lies in the failure to execute the pattern of behavior therapy. That which is known is based on scientific evidence and is that this psychomotor training is more effective if it increases in intensity and in time, and also that a teaching of the proposed therapy in consultation at the child's home environment can be beneficial.

The creativity of the therapist in consultation will help one get better results and benefits from Headpod.

For the correct approach to the patient in consultation, it is necessary to avoid confrontation, do not try at all costs to locate the device as this can mean total failure in accepting Headpod. It may be necessary to familiarize the child with the components of the device, the pieces, the touch, the textures, so that there is no defensive rejection thereof. All this may take time, even a few sessions. In some cases, patience and perseverance are necessary characteristics for successful adaptation to Headpod.

It should be noted that in some cases there is an increased sensitivity to pressure on the head, so we must adjust the Headpod so as to apply sufficient pressure to hold onto the head correctly but not cross the threshold of tolerance. It shouldn't perform vertical neck traction, for a greater traction of the rubber strap we will need a higher pressure on the frontal strap so that Headpod doesn't slide off.

In some cases it may be helpful for the child to see other children, a family member or a caregiver, or therapist with Headpod put on to decrease the fear towards this new device.

Practices in adults

These same physiological effects occur in adult patients, so Headpod may be used in cases where rehabilitation is indicated in cervical proprioception, postural, mobility, balance, eye-hand coordination, etc. Up until now proprioception exercises have been an integral part of the rehabilitation of lower extremity injuries, however, it has not had a prominent place in the treatment of cervical disorders, which opens up the possibility of a new therapeutic approach.

As from the third visit we can begin the work of education of the parents, other relatives or assistants if we are to prescribe Headpod for daily patient use. To do this we will identify the activities that can be recommended for each patient: meals, activities at school or at home, therapeutic activities (physiotherapy, speech therapy, occupational therapy, education...), etc. In each case we evaluate the most appropriate application time to be employed from only a few moments up to almost all the hours of the day, this being particular to each case, and whether or not it is necessary to apply a progressive pattern of use.

The dystonias occurring in the limbs are not generally a problem for the adaptation of Headpod always given that these types of movements do not significantly affect the neck. In those cases where trunk hypertonia and falling of the head due to muscle weakness are combined, then more evaluative work should be done by professionals to determine whether Headpod can be of some help, and moreover get to know both the guidelines of use that may be recommended in these cases in the consultation as well as its possible use at home or at school in some activity, in which case family members or caregivers should be trained on how best to use it. We can also find some children who will not cooperate initially with Headpod's use for various reasons. In these cases you can try a progressive implantation/introduction technique, this in itself being another important evaluation activity that can be developed in the consultation.

GOALS, BENEFITS AND SIDE EFFECTS

The two main objectives are:

1. Prevent head “fall” in anterior or lateral flexion, and
2. Facilitate the rotation of the head.

This will provide us with many benefits, amongst which we can mention:

- Obtain a more physiological and upright neck and head position, thereby allowing this to move and rotate easily, further enhancing the development of the muscles of the neck because the child then takes advantage of the offloading of the weight of his head to mobilize and move it more and better.
- Be able to eat more comfortably and securely.
- Help prevent musculoskeletal deformities, contractures and the soreness associated with both.
- Having a better visual communication with the environment, improving hand-eye coordination.
- Having a balanced and centered stance and a more relaxed muscle tone to assist in the performance of any activity, such as those involving physical therapy, speech therapy, and occupational therapy education.
- Decrease drooling in adopting a position that facilitates swallowing.
- Improve pulmonary ventilation, reducing complications such as respiratory failure, pneumonias, bronchiectasis, etc.
- Improved ergonomics and injury prevention for the professional caregivers.

There are no known side effects associated with the use of Headpod.

We recommend the use of Headpod for periods shorter than 60 minutes in people with dermatitis or in those where a pressure mark on the skin develops that does not disappear 45 minutes after removing the device.

CHAPTER 6

RESEARCH

The studies carried out so far are related overall to the experimental use of Headpod in children and adults with disability, and they have evaluated principally the effect it has on these people when they are asleep during a car journey. Studies of people with disabilities are extremely difficult to standardize in order to be able to apply proper scientific methodology; this is due to the great diversity in the affliction to be found in each patient. So for now we have just completed one study that has been conducted on a small group of people with disabilities, nevertheless we hope that in the future many of the therapeutic facets of Headpod will be able to be studied.

- *Evaluation of a new device for head positioning control in physically impaired people.* Centro Ramon y Cajal de ASPACE, Zizur, Navarra (Spain).
- *Reduction in the exposure to being out-of-position among car occupants who used a sleeping device.* University of Virginia (USA) and European Center for Injury Prevention.
- *Sleep evaluation in car passengers using a seat head hammock new device.* Sleep Unit and Department of Neurophysiology, Txagorritxu Hospital, Vitoria (Spain).
- *Child posture and shoulder belt fit during extended night-time traveling: an in-transit observational study.* University of Virginia (USA) and European Center for Injury Prevention.
- *A New Headrest Hammock For Enhancing Sleep In Car Passengers. A randomized, controlled trial to evaluate objective and subjective sleep.* University of the Basque Country and Sleep Unit of Txagorritxu Hospital, Vitoria (Spain).