

Headpod[®]

PATENTED

“Dynamic Head Suspension”

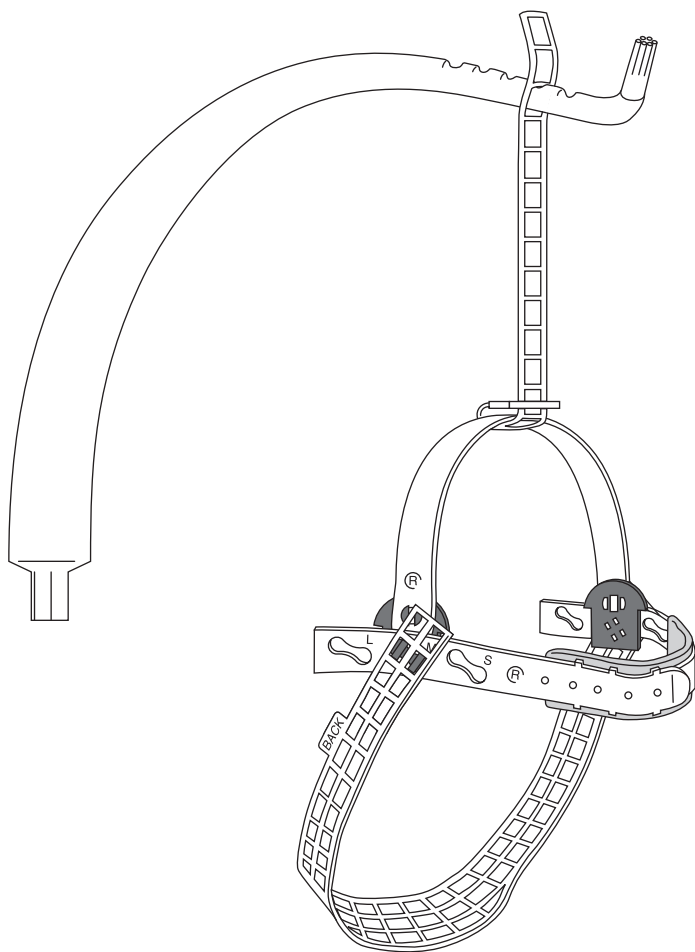

ENGLISH

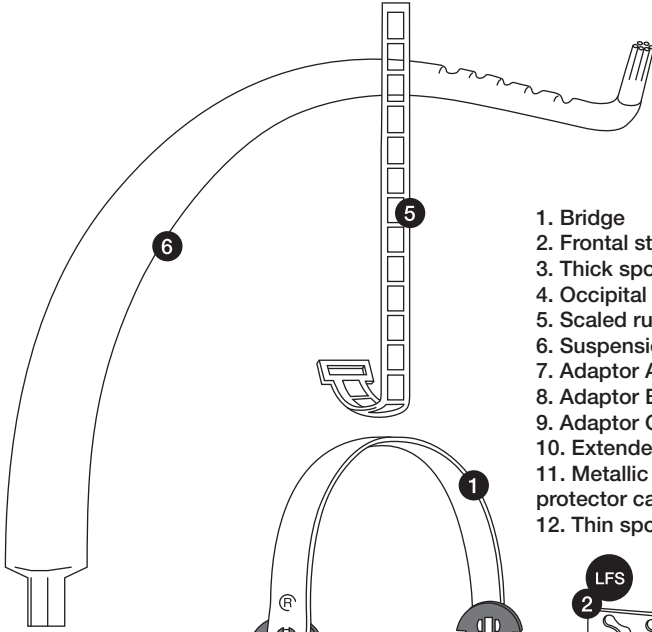

1. Bridge
2. Frontal straps (RFS / LFS)
3. Thick sponge padding
4. Occipital mesh
5. Scaled rubber strap
6. Suspension arm
7. Adaptor A
8. Adaptor B
9. Adaptor C
10. Extender
11. Metallic tube with protector caps
12. Thin sponge padding

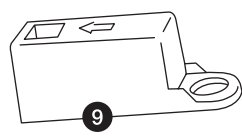
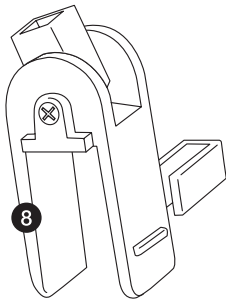
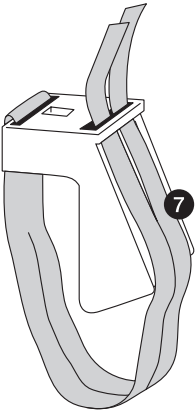
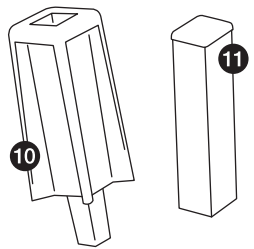
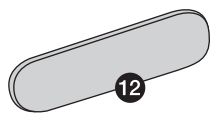
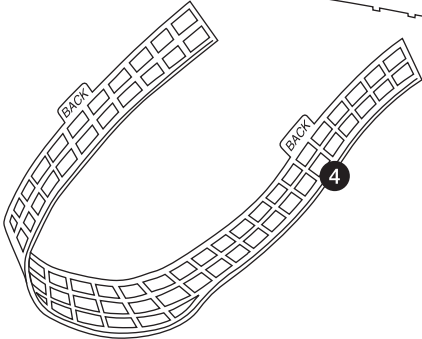
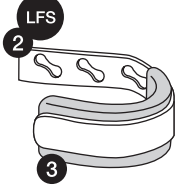
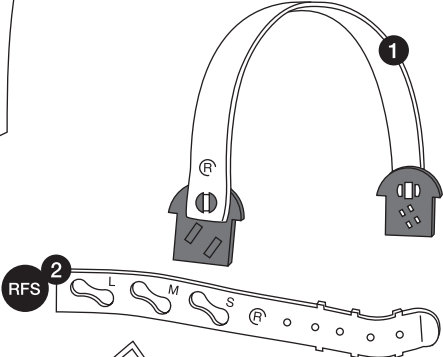

Congratulations! You are holding **Headpod®** a revolutionary device that helps keep the head upright. This is a new concept we have called: **Dynamic Head Suspension.**

Headpod® is a CE certified and FDA registered device, invented, developed and patented by Siesta Systems S.A.

To ensure correct use of Headpod®, please read the instructions you have in your hands.

Headpod® indications

Headpod is the best solution for people unable to sustain the weight of their own head due to neck weakness (low tone).



Ideal for children aged 2 to 8 with cerebral palsy or any syndrome causing hypotonia in the neck muscles.



Very suitable for children up to 15 years old who have no severe spasticity, or musculoskeletal deformities.



Recommended for adults who have no muscle or joint deformations or mechanical restrictions that prevent the head from being fully upright. Use in adults is recommended in cycles shorter than 60 minutes and especially useful during mealtime, computer activities or transportation.



Not indicated in people with Amyotrophic Lateral Sclerosis (ALS) or other advanced diseases presenting severe dysphagia, and children with a great deal of extensor tone in the trunk.

No known side effects have been observed while using Headpod®.



Adjusting Headpod® before first use

The following instructions show how to adjust your Headpod® for the first time. First, measure the cranial circumference of the person who will use it. Then, with these measures, follow the chart and select the bridge that best matches.

Cranial perimeter	Bridge
Less than 50 cm	Green
Between 50-60 cm	Grey
Over 60 cm	Black

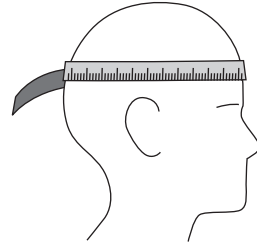

Preparing the harness

Step 1: Bridge and frontal straps

Take the selected bridge (1) and insert each frontal strap (2) in the corresponding orange segment of the bridge. For a proper fit, use the hole (L, M or S) that corresponds to the table shown below. The Right Frontal Strap (RFS) is identified with the letter R, which must be on the right side of the bridge, which is also marked with an R as shown in the illustration. The Left Frontal Strap (LFS) is identified with the letter L and must be on the left side of the bridge. The black side of the sponge padding (3) is attached to the Velcro located inside the left frontal strap.

Step 2: Assembling the occipital mesh

Next, join the occipital mesh (4) to the orange pieces using the paired holes in the mesh. To find out which row of holes matches, use the following table for guidance:

Cranial perimeter	RFS	LFS	Row
Less de 48 cm	S	M	6 th
Between 48-49 cm	M	M	6 th
Between 49-50 cm	M	M	5 th
Between 50-52 cm	M	M	4 th
Between 52-54 cm	M	L	4 th
Between 54-57 cm	M	L	3 rd
Between 57-59 cm	L	L	3 rd
Between 59-61 cm	L	L	2 nd
More than 61 cm	L	L	1 st

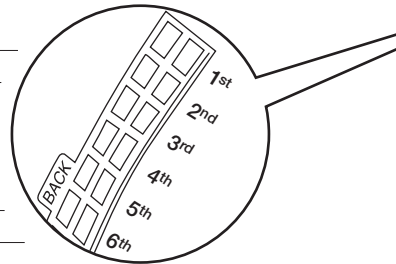

Be sure that the word BACK is facing the back as shown.

Make sure the occipital mesh is snugly adjusted to lower contour of the head and as close as possible to the ears without going over them.

In the recommended position, the orange segments of the bridge should be positioned on the front border of both ears as shown in the illustration by dashed line (A). Otherwise, adjust the mesh to achieve that goal.

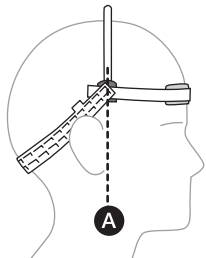
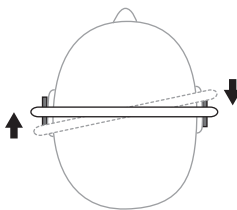
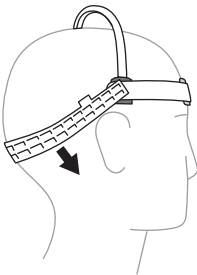
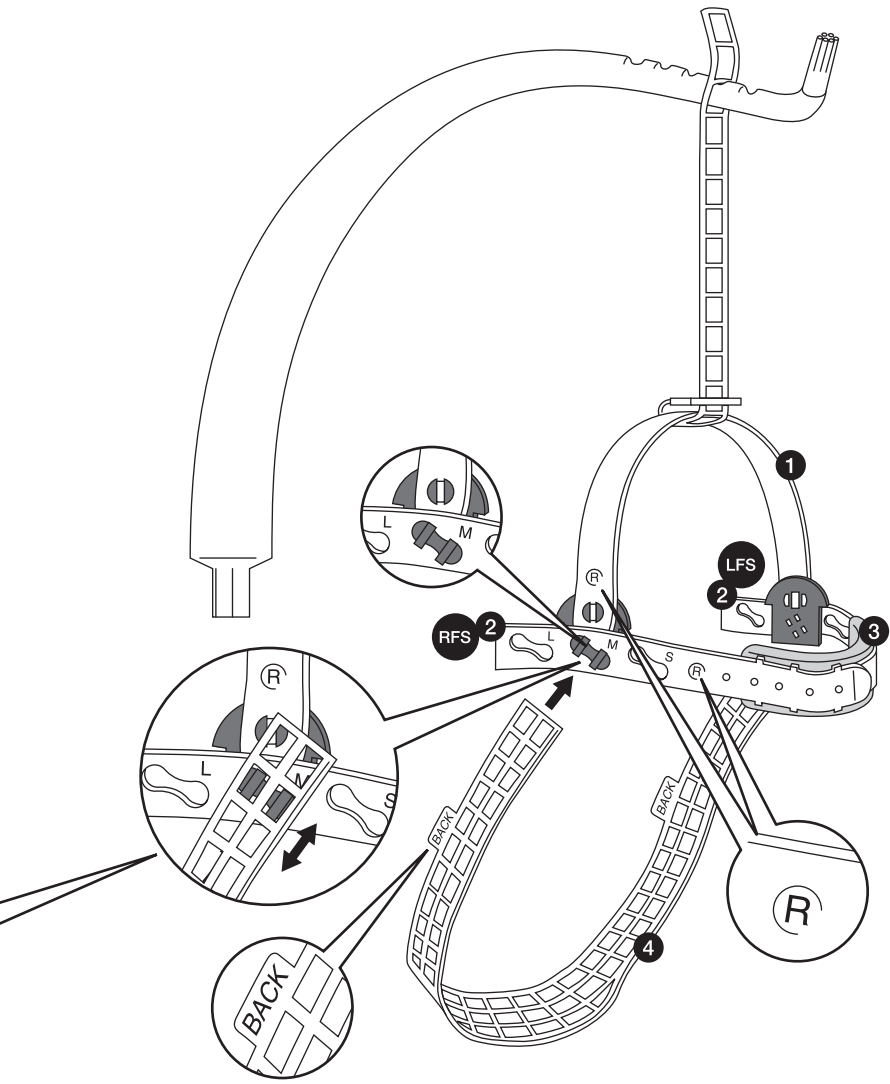

Installing the adaptor

After adjusting the Headpod® harness, the suspension arm (6) should be installed in an adaptor fixed to the top of the chair or location where it will be used.

IMPORTANT: The adaptor should be firmly fixed to prevent the suspension arm from rotating towards the front.

Given the variety of wheelchairs and seats, we provide three different adaptors (7, 8 and 9), plus an extender (10) that can be adapted to any of them in case the suspension arm needs to be higher.

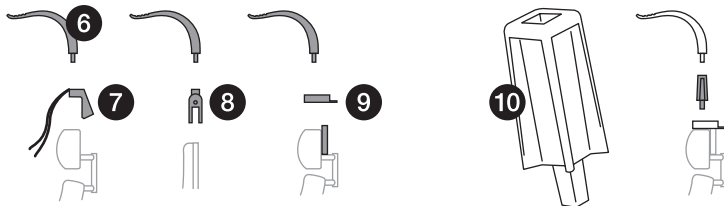

Adaptor for chairs with headrest

If the seat has a headrest use this adaptor (7) as shown in the next page. Firmly tighten the straps upward before adhering to the Velcro so that the upper surface of the adaptor remains horizontal and stable when in use.

Adaptor for chairs with a rigid back

If the seat has a rigid back use this adaptor (8) as shown. Place the back in a nearly vertical position (approx. 80°). There are two wedges to provide firmer adjustment on the back. Tape can be applied around each of the lower wings to achieve a more precise adjustment. Finally install the suspension arm on the adaptor.

Adaptor Universal

This adaptor (9) is designed to be used when none of the previous adaptors can be firmly fixed. A square metallic tube 15 x 15 mm (11), should be previously installed in the chair as close as possible to the rear edge of the back or headrest and protruding between 25 and 30 mm above. Ask your orthopedic technician about installing this piece (not included in the price of Headpod).

Select one of the two positional options of the adaptor to be inserted on the tube. The adaptor should be approximately the height of the upper edge of the user's head.

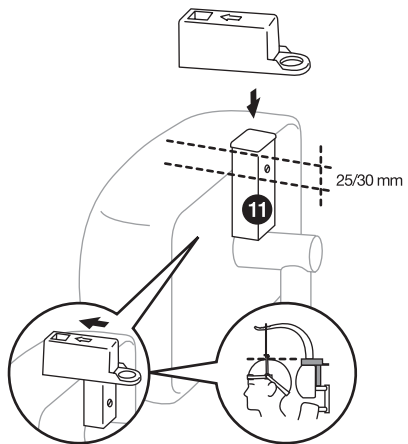
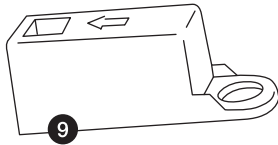
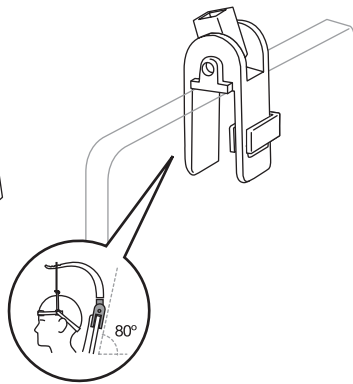
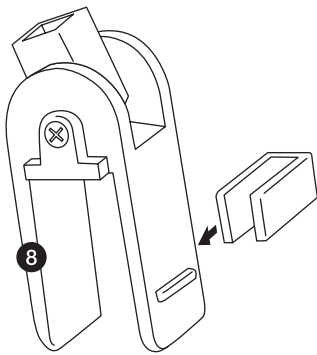
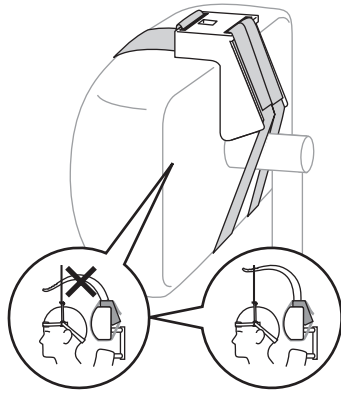
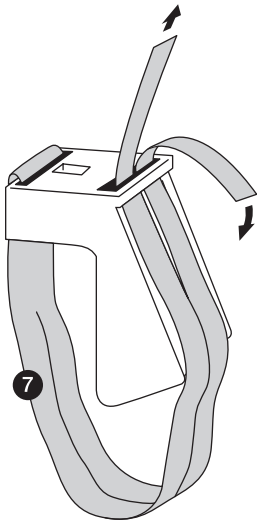

Daily use of Headpod®

The steps above are only required before first use. For daily Headpod® use, place yourself in front of the user and follow these steps:

1 Close the Velcro across the forehead.

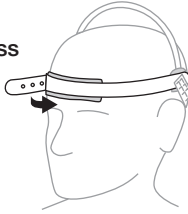

2 Move the occipital mesh downward as close to the ears as possible without going on top of them.

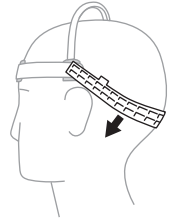

3 Be sure the bridge is parallel to the user's forehead.

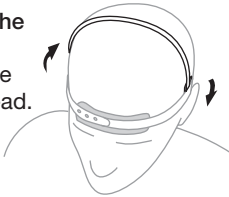

4 Re-tighten the Velcro strap if loose.

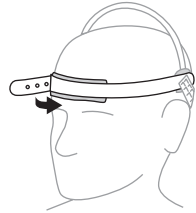

5 While holding the chin with one hand, hang the scaled rubber strap on the suspension arm at a height that keeps the head in a vertical position.

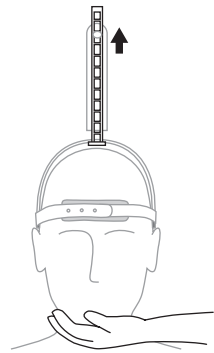
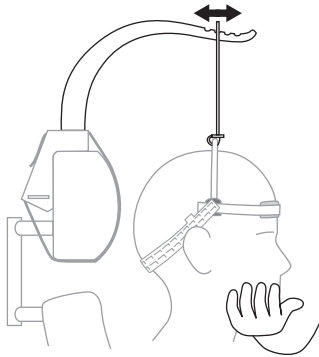

The head should not be forward (hyper-flexion) or backward (hyper-extension). To avoid this, move the strap along the suspension arm as indicated in the illustration by the horizontal arrow to achieve the desired position.

If the head falls to either side (lateral flexion), hold the chin again and move the scaled rubber strap up another rung, as indicated in the illustration by the vertical arrow. By doing so, the correct position of the head can be achieved.

Recommendations for use

REMEMBER: The adaptor must be firmly fixed to prevent the suspension arm from leaning forward.

- To prevent hyper-extension of the neck and keep the face in a vertical position **place the back in a nearly vertical position (approx. 80°)**, and move the scaled rubber strap along the suspension arm. If hyper-extension persists place a small cushion behind the head to avoid neck extension.
- Always use a harness, straps or positioning mold that holds the torso upright.
- If the user has long hair, we recommend collecting it in a “bun” and situating the occipital mesh below it.
- Start out by using Headpod® during meals and during rest periods when there are only few people around. Avoid stress situations that may make the user nervous.
- The user may initially show resistance to the new head position since they may be accustomed to poor posture. In these cases, several weeks of adaptation may be needed.
- Not recommended for daily use in excess of 6-8 hours, except in children with severe hypotonia, who clearly benefit from extended utilization.
- Some people, especially users with dermatitis, may have increased sensitivity to pressure by the device on the forehead. Reduce the time of use if red marks from wear do not disappear an hour after use.
- Because the Headpod® can move if incorrectly fitted, do not leave the user unattended, especially if the user is a person who is unable to communicate verbally.
- In adults: we recommend reclining the chair back a little bit, and to use Headpod® for limited periods of 30-60 minutes like mealtime, computer activities or transportation.

Maintenance

Keep Headpod® in a clean and dry place.

Do not expose to temperatures above 50°C or expose to sunlight for prolonged periods of time (behind glass or exposed directly).

Rubber parts and plastic can be washed with warm water and soap.

Sponge padding should not be moistened. Gently wash the surface that comes into contact with the skin.

This device has a limited lifespan and must be replaced with original parts when it shows signs of evident deterioration.

Warranty

Headpod® has a 1 year warranty from the date of purchase for defects in materials or manufacturing. The warranty does not, in any case, cover improper use or natural wear and tear.

Remember to save the invoice with the date and place of purchase in order to use the warranty.

Siesta Systems S.A. is not liable of the errors or omissions that could be included in this manual, and reserves the right to change its specifications without prior notice.