

StarLock

Quick guide

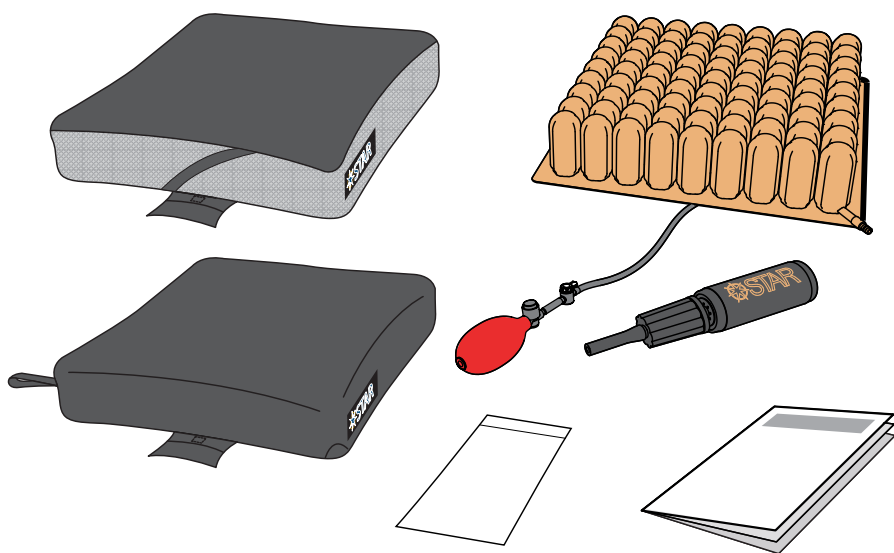

QF71-52.1 22-05-23



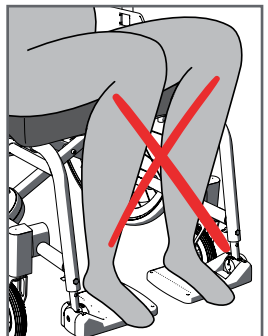
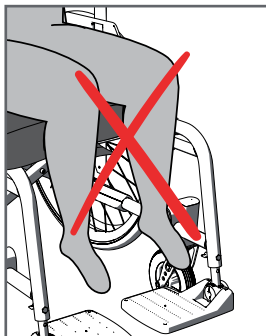
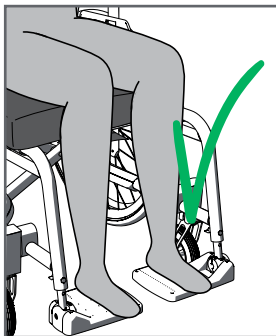
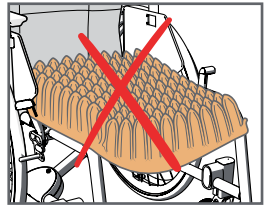
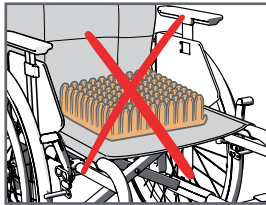
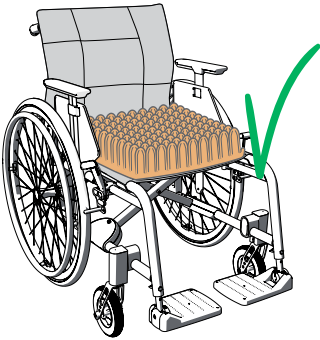
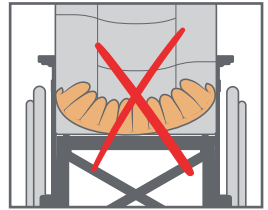
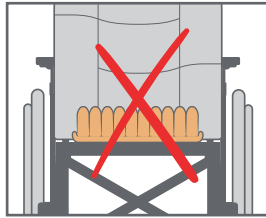
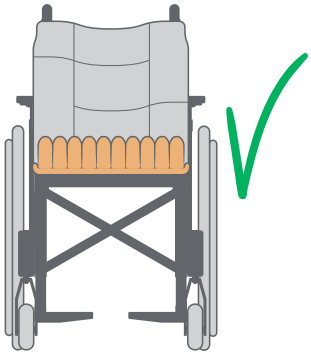
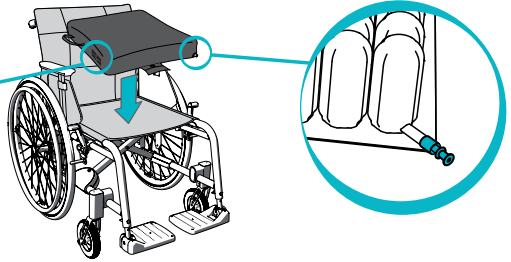
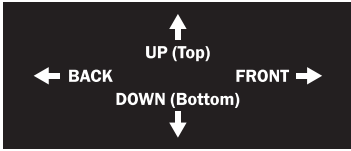

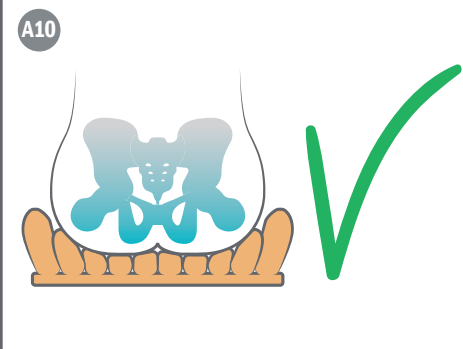
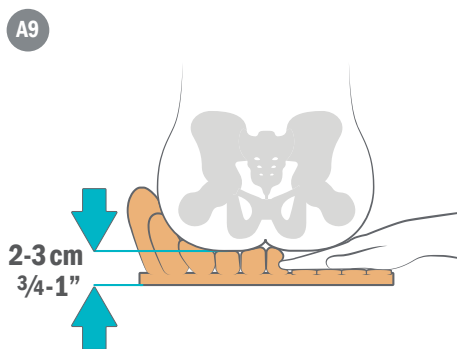
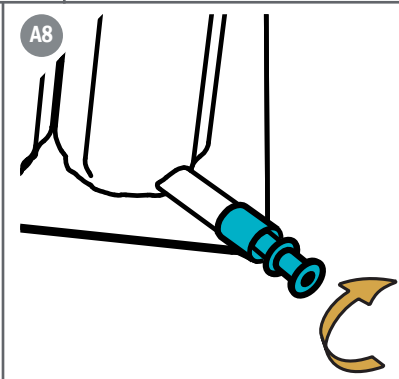
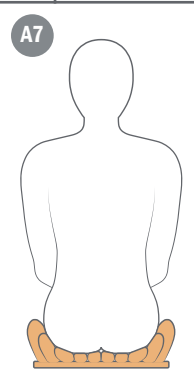
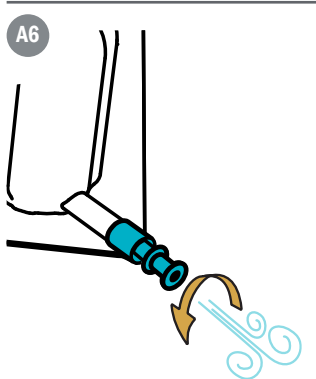
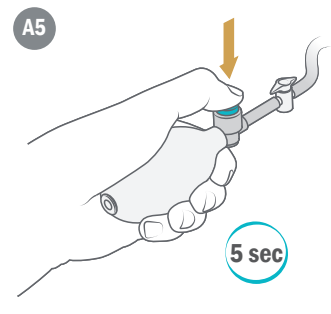
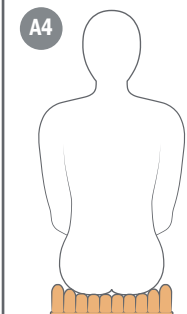
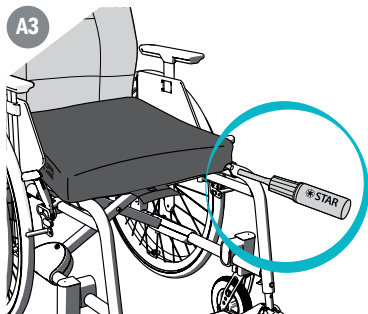
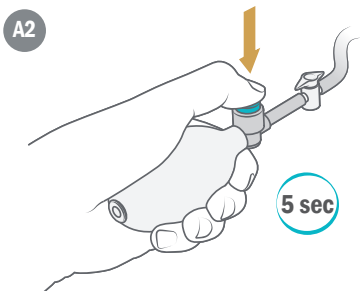
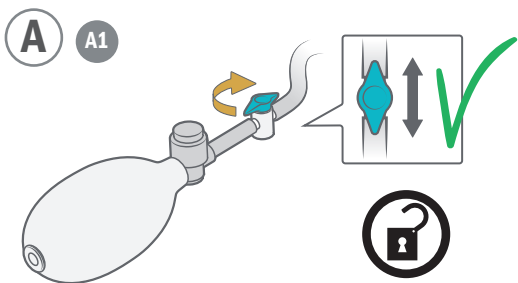

A1-A10 ✓

B

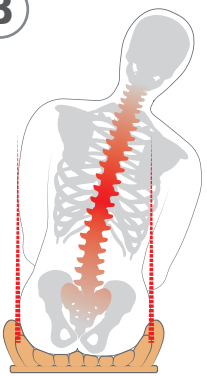

B1

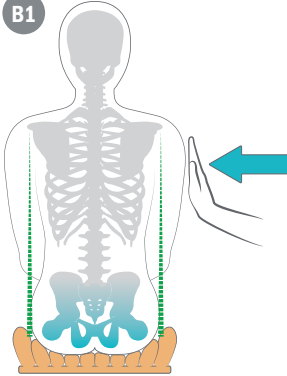

B2

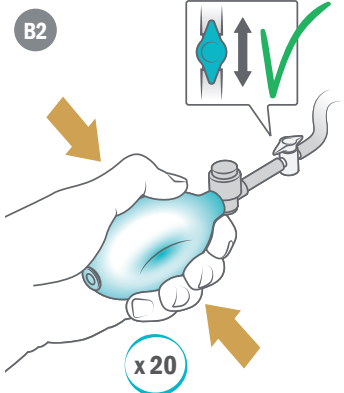

B3

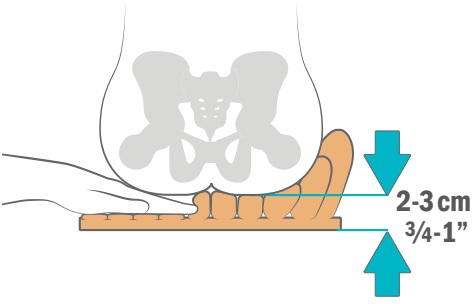

B4

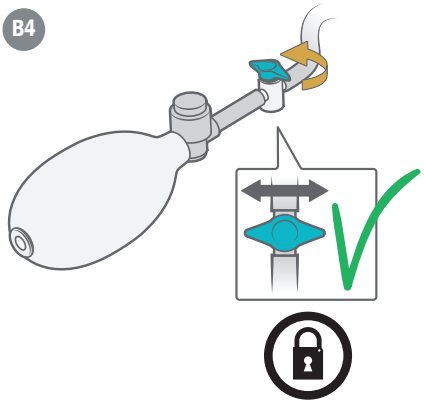

B5

