

Part No.	Description	Arm Length	Max. Neck Circumference	Max. Neck Width	MSRP Price
i2i 280	Niño XSmall Standard	4.5"	7"	3"	\$699
i2i 380	Niño Small Standard	4.5"	9"	3.5"	\$699
i2i 480	Small Standard	6.5"	11"	4"	\$699
i2i 481	Small Short Arm	4.5"	11"	4"	\$699
i2i 580	Medium Standard	7.5"	14"	4.5"	\$699
i2i 581	Medium Short Arm	5.5"	14"	4.5"	\$699
i2i 680	Large Standard	8"	16"	5"	\$699
i2i 681	Large Short Arm	6"	16"	5"	\$699
i2i 780	Extra Large Standard	9"	18"	5.75"	\$699
i2i 781	Extra Large Short Arm	6.25"	18"	5.75"	\$699

Sizes in inches

Customer: _____

Contact: _____

PO Number: _____

Mark for: _____

Date: _____

Ship to: _____

Address: _____

City: _____ State: _____ Zip Code: _____

Phone: _____

Email: _____

i2i Modifications

- Gel Insert • \$169
- Sheep Skin • \$100
- Reverse Dartex • \$0
- Low Profile • \$0
- Adjustable Arms • \$20
- Reinforced Steel Stabilizer Arm • \$25

Ear Cutout

- Left Right Both

i2i Add-Ons

- Tone Deflector • \$200

Swing Away

- Left • \$325 Right • \$325 Both • \$410

Other Specify: _____

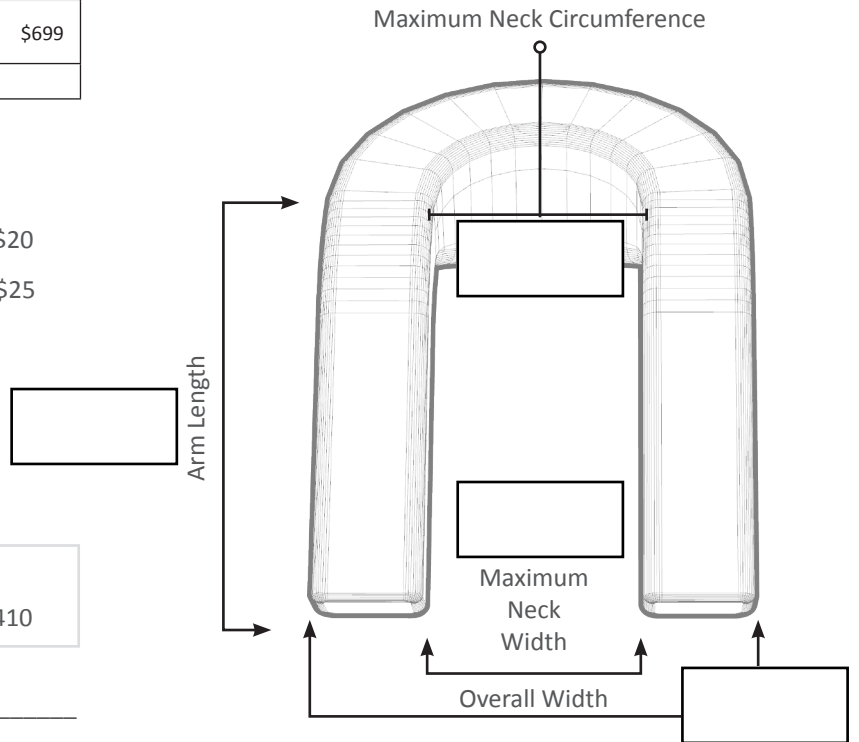

Notes:





Measuring Customization Information

i2i drawing to be marked for Customization Needs.

- For example:
- If you need foam build-up or removal
 - If you want get padding on selected areas (other than shown standard)
 - If you need custom arm length

How to measure:

- Start at point A
 - Measure to point B
- See illustration in the left for reference.

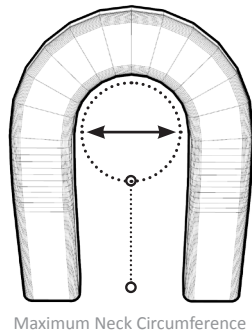
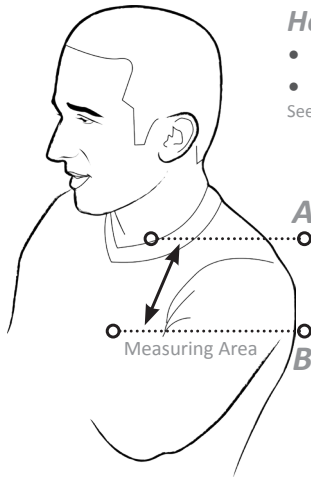

Standard Profile

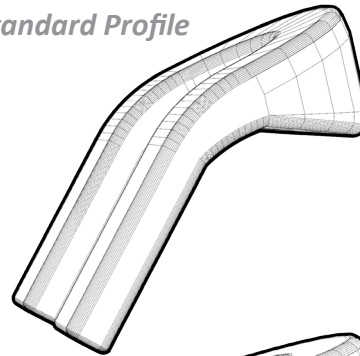

- 280 ▶ 2.25"
- 380 ▶ 2.25"
- 480 ▶ 4"
- 580 ▶ 4.75"
- 680 ▶ 5.25"
- 780 ▶ 6"

Low Profile

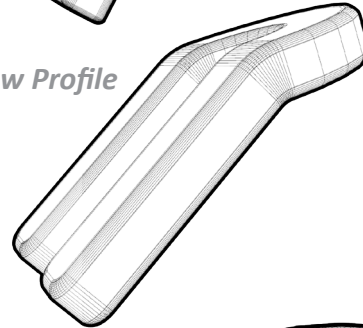

- 280 ▶ 2.25"
- 380 ▶ 2.25"
- 480 ▶ 2.25"
- 580 ▶ 2.25"
- 680 ▶ 2.25"
- 780 ▶ 2.25"



- 281
- 381
- 481
- 581
- 681
- 781

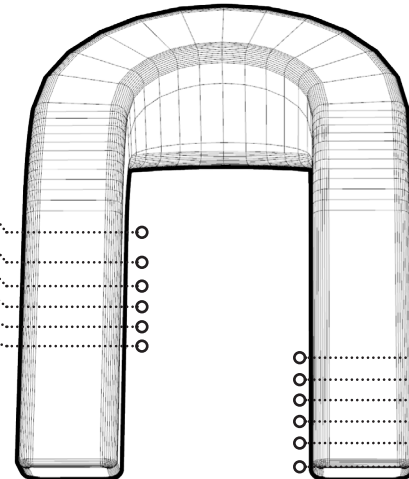

- 280
- 380
- 480
- 580
- 680
- 780

Standard Gel Insert

See order form in the previous page for cost and details.

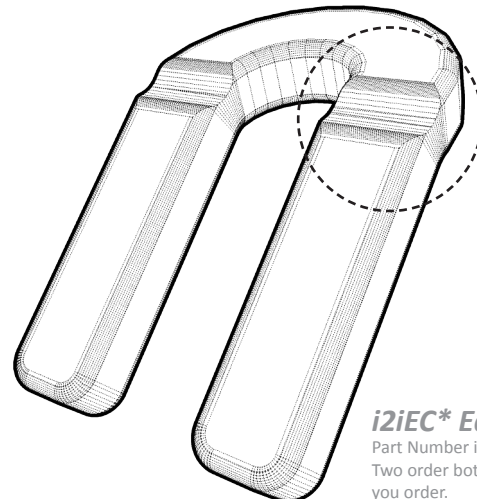
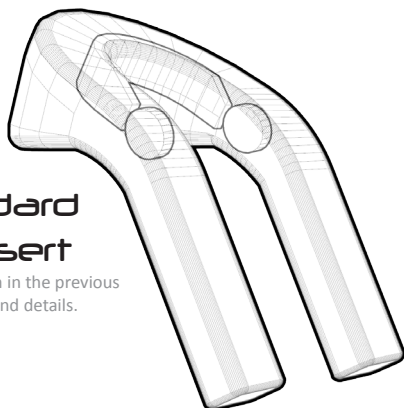

i2iEC* Ear Cutout

Part Number is for one side only. Two order both side specify 2 in your order.

