

# KID KART

## *Kid Kart*<sup>®</sup> Mighty Lite

SUPPLIER: THIS MANUAL MUST BE GIVEN  
TO THE USER OR OWNER OF THIS  
DEPENDENT MOBILITY BASE.

BEFORE USING THIS DEPENDENT MOBILITY BASE READ  
THIS ENTIRE MANUAL AND SAVE FOR FUTURE REFERENCE.

*User*

*Instruction*

*Manual &*

*Warranty*

**I. SUNRISE LISTENS**

Thank you for choosing this dependent mobility device. We want to hear your questions or comments about this manual, the safety and reliability of your mobility device, and the service you receive from your Sunrise Medical supplier. Please feel free to write or call us at the address and telephone number below:

**SUNRISE MEDICAL**

Be sure to return your warranty card, and let us know if you change your address. This will allow us to keep you up to date with information about safety, new products and options to increase your use and enjoyment of this mobility device. If you lose your warranty card, call or write and we will gladly send you a new one.

**FOR ANSWERS TO YOUR QUESTIONS**

Your authorized supplier knows your mobility device best and can answer most of your questions about safety, use and maintenance. For future reference, fill in the following:

**Supplier:** \_\_\_\_\_

**Address:** \_\_\_\_\_

\_\_\_\_\_

**Telephone:** \_\_\_\_\_

**Serial #:** \_\_\_\_\_ **Date/Purchased:** \_\_\_\_\_

|  |    |
|--|----|
| <b>III. YOUR CHAIR AND ITS PARTS</b> .....             | 6  |
| Technical Specifications .....                         | 7  |
| <b>IV. GENERAL WARNINGS</b> .....                      | 8  |
| A. Weight Limit .....                                  | 8  |
| B. Getting to Know Your Mighty Lite .....              | 8  |
| C. Safety Checklist .....                              | 8  |
| D. Changes & Adjustments .....                         | 9  |
| E. Environmental Conditions .....                      | 9  |
| F. Street Use .....                                    | 9  |
| G. Motor Vehicle Safety .....                          | 9  |
| H. For Caregivers .....                                | 10 |
| <b>V. WARNINGS FOR SAFE USE</b> .....                  | 11 |
| A. Transit Use .....                                   | 11 |
| B. Center of Balance .....                             | 12 |
| C. Dressing or Changing Clothes .....                  | 12 |
| D. Obstacles .....                                     | 12 |
| E. Reaching or Leaning .....                           | 12 |
| F. Ramps, Slopes & Sidehills .....                     | 13 |
| G. Transfers .....                                     | 13 |
| H. Curbs & Steps .....                                 | 13 |
| I. Climbing Stairs .....                               | 14 |
| J. Descending Stairs .....                             | 14 |
| K. Escalators .....                                    | 14 |
| L. Maintenance .....                                   | 14 |
| <b>VI. WARNINGS FOR COMPONENTS &amp; OPTIONS</b> ..... | 15 |
| A. Transit Option .....                                | 15 |
| B. Tray Supports .....                                 | 15 |
| C. Cushions and Seating Accessories .....              | 15 |
| D. Fasteners .....                                     | 15 |
| E. Footplates .....                                    | 16 |
| F. Positioning Belts .....                             | 16 |
| G. Power Drive .....                                   | 16 |
| H. Wheel Locks .....                                   | 16 |
| I. Modified Seating Systems .....                      | 16 |
| J. Upholstery Fabric .....                             | 16 |

|  |    |
|--|----|
| <b>VII. OPERATING INSTRUCTIONS</b> .....           | 17 |
| A. Wheel Locks .....                               | 17 |
| B. Unfolding .....                                 | 17 |
| C. Folding .....                                   | 17 |
| D. Transit Use .....                               | 18 |
| E. Transit Option Installation Instructions .....  | 18 |
| F. Positioning and Growth Adjustments Guide .....  | 19 |
| G. Seat Depth Adjustment .....                     | 20 |
| H. Seat and Back Angle Adjustment .....            | 21 |
| I. Footrest Adjustments .....                      | 22 |
| J. Pelvic Positioning Belt Length Adjustment ..... | 22 |
| K. Crutch Strap Depth Adjustment .....             | 23 |
| L. "H" Harness .....                               | 23 |
| M. Headrest Extensions .....                       | 23 |
| <b>VIII. SET-UP MATRIX</b> .....                   | 24 |
| <b>IX. MAINTENANCE</b> .....                       | 28 |
| <b>X. LIMITED WARRANTY</b> .....                   | 29 |
| <b>MIGHTY LITE ACCESSORIES</b> .....               | 30 |

## III. YOUR CHAIR AND ITS PARTS



## KID KART MIGHTY LITE

- |  |                                  |
|--|----------------------------------|
| 1. Wheel locks                             | 7. Footplate                     |
| 2. Wheel                                   | 8. Three-points positioning belt |
| 3. Locking Brace                           | 9. "H" Harness & Padded Covers   |
| 4. Caster                                  | 10. Closure Strap                |
| 5. Push Handle                             | 11. Headrest Extension           |
| 6. Transit Securement Points<br>(optional) |                                  |

## TECHNICAL SPECIFICATIONS

## Color Options

Frame: black

Fabric: navy or raspberry

## Adjustment ranges

Adjustable Seat Angle: 15° & 22°

Adjustable Back Angle: 85°, 90°, 95°

| Measurements            | 12"   | 14"   | 16"   | 18"   |
|-------------------------|-------|-------|-------|-------|
| Weight (lbs)*           | 26.95 | 27.50 | 28.35 | 28.95 |
| Seat width (hip)        | 11.75 | 13.75 | 15.5  | 17.5  |
| Knee width              | 16.5  | 18.5  | 19.75 | 20.75 |
| Top of headrest to seat | 30    | 30    | 32    | 32    |
| Top of backrest to seat | 23    | 23    | 25    | 25    |
| Headrest width          | 10    | 12    | 14    | 16    |
| Backrest width          | 13.5  | 15.5  | 17.5  | 19.5  |

\* Standard Model (without footplates, transit kit, or any optional equipment). All Mighty Lite frames are Transit-tested and approved and capable of adding Transit Kit at delivery or later as field upgrade.

All features may not be available with some configurations or in conjunction with another product feature. Please consult your supplier or customer service for more information. Your authorized supplier can also provide you with more information on accessories.

## IV. GENERAL WARNINGS

Throughout this section, you will find general warnings for the safe use of your dependent mobility device. It is important that you read and understand these warnings before you use this product. **If you fail to do so, a fall, tip over or loss of control may occur and cause severe injury to the rider, you or others.**

### WARNING

#### A. WEIGHT LIMIT

Never exceed the weight limit for the rider or items carried. The weight limit for the rider is 150 lbs either with Transit option or without Transit option. Never use the mobility device for more than one rider.

#### B. GETTING TO KNOW YOUR MIGHTY LITE

Read all instructions before using this product. In particular, you should:

1. Be trained in the safe use of this product by your health care professional.
2. Practice bending, reaching and transfers until you know the limit of your ability. Have someone help you until you know what can cause a fall or tip over and how to avoid doing so.
3. Be aware that you must develop methods for safe use best suited to your level of function and ability.
4. Never try a new maneuver on your own until you are sure you can do it safely.
5. Get to know the areas where you plan to use your mobility device. Look for hazards and learn how to avoid them.

#### C. SAFETY CHECKLIST

Before each use of this product:

1. Wheel locks must be adjusted to maintain proper performance. Always engage the wheel locks before transferring a child.
2. Make sure the mobility device rolls easily and that all parts work smoothly. Check for noise, vibration, or a change in ease of use. (They may indicate loose fasteners or other damage).
3. Repair any problem you may encounter. Your authorized supplier can help you find and correct any problems.
4. Never seat your child in the mobility device until it is fully unfolded and locked.
5. Use a pelvic positioning belt when the child is seated.
6. Never leave your child unattended.

## D. CHANGES & ADJUSTMENTS

1. See your health care professional and have them adjust components and accessories as your child grows.
2. Unauthorized modifications or use of parts not supplied or approved by Sunrise Medical may change the product's structure. This will void the warranty and may cause a safety hazard.

## E. ENVIRONMENTAL CONDITIONS

1. Your mobility device is designed for use on firm, even surfaces such as concrete, asphalt and indoor floors and carpeting.
2. Use extra care if you must use this mobility device on a wet or slick surface. If you are in doubt, ask for help.
3. Do not use this product in a shower, pool or other bodies of water.
4. Do not operate your mobility device in sand, loose soil or over rough terrain.

## F. STREET USE

1. This product is not intended for street use.
2. Be alert to the danger of motor vehicles on roads or in parking lots.
3. At night, or when lighting is poor, use reflective tape or clothing.
4. Due to your child's low position, it may be hard for drivers to see the rider. Make eye contact with drivers before you go forward. When in doubt, yield until you are sure it is safe.

## G. MOTOR VEHICLE SAFETY

As indicated on the front cover of this user manual, identify whether your chair has been manufactured with the Transit Option installed.

If your chair is NOT equipped with the Transit Option:

Mobility device products do not meet federal standards for motor vehicle seating.

1. NEVER let anyone sit in this product while in a moving vehicle.
2. ALWAYS move the rider to an approved vehicle seat.
3. ALWAYS secure the rider with proper motor vehicle restraints.
4. In an accident or sudden stop the rider may be thrown from the mobility device. Mobility device pelvic positioning belts will not prevent this and further injury may result from these belts or straps.
5. NEVER transport this mobility device in the front seat of a vehicle. It may shift and interfere with the driver.
6. When being transported in a vehicle, ALWAYS secure the unoccupied mobility device so that it cannot roll or shift.
7. Do not use this product if it has been involved in a motor vehicle accident.

If your chair is equipped with the Transit Option:

See sections: Warnings for Safe Use: Transit Use, Warnings for Components & Options and the Operating Instructions.

**H. FOR CAREGIVERS**

1. Work with the child's health care professional to learn safe methods best suited to your abilities and those of your child.
2. To prevent injury to your back, use good posture and proper body mechanics when lifting or tilting your child.
3. Remind the child to lean back when you tilt the mobility device backward.
4. When you descend a curb or single step, slowly lower the mobility device in one easy movement.
5. NEVER leave the child alone.
6. When making adjustments to the mobility device, always engage the wheel locks to help minimize unintended movement.

**V. WARNINGS FOR SAFE USE****A. TRANSIT USE**

1. If possible and feasible, the child should be transferred to a car seat and the vehicle restraint used.
2. If the mobility device is used for transport and has been installed with the Transit Option, it must be used in a vehicle equipped for forward-facing securement during transport.
3. The rider must not weigh more than 150 lbs.
4. Figures 1 & 2 show the location of the transit securement points (A) for this product.
5. Use only with Wheelchair Tiedown and Occupant Restraint Systems (WTORS) that have been installed in accordance with the manufacturer's instructions and SAE J2249. (See your local medical equipment supplier.)
6. Attach WTORS to securement points in accordance with the manufacturer's instructions and SAE J2249.
7. Attach occupant restraints in accordance with the manufacturer's instructions and SAE J2249.

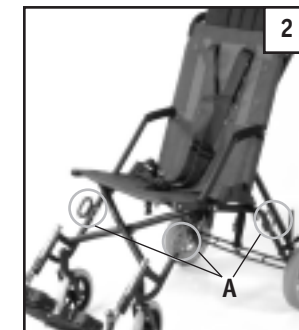

## B. CENTER OF BALANCE

Kid Kart mobility devices are designed for stability and performance. The point where this device will tip forward, back, or to the side depends on its center of balance and stability. The center of balance is also affected by:

- The distance between the rear wheels.
- The seat height and seat angle.
- Backrest angle.
- Changes in your child's body position, postures or weight distribution.
- Pushing the mobility device on a ramp or slope.
- The use of a backpack or other options, and the amount of added weight.

To maintain the proper center of gravity and balance:

- Consult your therapist and supplier when the mobility device is set up.
- Consult your authorized supplier or therapist BEFORE you modify or adjust the mobility device.

## C. DRESSING OR CHANGING CLOTHES

Your child's weight may shift if you dress or change your child's clothes while they are seated in the mobility device. To reduce the risk of a fall or tip over while changing clothes or diapers:

- Rotate the front casters until they are as far forward as possible.
- Engage the wheel locks

## D. OBSTACLES

Obstacles and road hazards (such as potholes and broken pavement) can damage your mobility device and may cause a fall, tip over or loss of control. To avoid these risks:

- Scan the area well ahead for danger as you push the mobility device.
- Make sure the floor areas ahead are level and free of obstacles.
- Install a ramp at entry or exit doors. Make sure there is not a drop off at the bottom of the ramp.

## E. REACHING OR LEANING

If your child reaches or leans it will affect the center of balance of your mobility device. This may cause a fall or tip over.

- NEVER allow your child to reach or lean if they must shift their weight sideways, forward, or backward and rise up off the seat.
- If your child must reach, move the mobility device as close as you can to the object they wish to reach and rotate the front casters until they are as far forward as possible.

**NOTE–** To do this: Move your mobility device past the object you want to reach, then back up alongside it.

## F. RAMPS, SLOPES & SIDEHILLS

Pushing the mobility device on a slope, including ramps or hills, will change the center of balance. A few safety reminders include:

1. Do not push this product on a slope steeper than 10%. (A 10% slope means: one foot in elevation for every ten feet of slope length.)
2. Do not turn or change direction on a slope or ramp.
3. For your child's safety, ramps at home and work must meet all legal requirements for your area.
4. Always stay in the CENTER of the ramp.
5. Use a ramp with guardrails (or raised borders at least 3" high).
6. Always go straight up and straight down on hills or ramps.
7. Do not stop on a steep slope.
8. Watch for a drop-off at the bottom of a slope or ramp.
9. Do not engage the wheel locks to slow or stop your mobility device.
10. Beware of wet or slippery surfaces.
12. Ask for help any time you are in doubt.

## G. TRANSFERS

1. Work with your health care advisor to learn safe transfer and lifting methods.
2. Have someone help you until you know how to do a safe transfer of your child on your own.
3. Engage the wheel locks before you transfer. This keeps the rear wheels from rolling.
4. Move your child's mobility device as close as you can to the seat you are transferring to.
5. Rotate the front casters until they are as far forward as possible.
6. Transfer your child as far back onto the seat surface as you can. This will reduce the risk that the mobility device will tip or move away from you.

## H. CURBS & STEPS

Follow the instructions below for descending or climbing a stair or curb. Do not try to climb a high curb or step (more than 4 high) unless you have help. Doing so may cause your mobility device to exceed its balance point and tip over.

To descend a curb or single step going BACKWARD:

1. Stay at the rear of the mobility device.
2. Several feet before you reach the edge of the curb or step, turn the mobility around and pull it backward.
3. While looking over your shoulder, carefully step back until you are off the curb or stair and standing on the lower level.
4. Pull your mobility device toward you until the rear wheels reach the edge of the curb or step. Then allow the rear wheels to slowly roll down onto the lower level.



5. When the rear wheels are safely on the lower level, tilt the mobility device back to its balance point. This will lift the front casters off the curb or step.
6. Keep the mobility device in balance and take small steps backward. Turn the mobility device around and gently lower front casters to the ground.

To climb a step or curb going FORWARD:

1. Stay behind the mobility device.
2. Face the curb and tilt the mobility device up on the rear wheels so that the front casters clear the curb or step.
3. Move forward, placing the front casters on the upper level as soon as you are sure they are past the edge.
4. Continue forward until the rear wheels contact the face of the curb or step. Lift and roll the rear wheels to the upper level.

### I. CLIMBING STAIRS

1. Use at least two attendants to move this mobility device up stairs.
2. Move the mobility device and rider BACKWARD up the stairs.
3. The person at the rear is in control. He or she tilts the mobility device back to its balance point.
4. A second attendant at the front firmly grasps a non-detachable part of the front frame and lifts the mobility device up and over one stair at a time.
5. The attendants move to the next stair up. Repeat for each stair, until you reach the landing.

### J. DESCENDING STAIRS

1. Use at least two attendants to move an occupied mobility device down stairs.
2. Move the mobility device and rider FORWARD down the stairs.
3. The person at the rear is in control. He or she tilts the mobility device to the balance point of the rear wheels and rolls it to the edge of the top step.
4. A second attendant stands on the third step from the top and grasps the frame. He or she lowers the chair one step at a time by letting the rear wheels roll over the stair edge.
5. The attendants move to the next stair down. Repeat for each stair, until you reach the landing.

### K. ESCALATORS

NEVER use this mobility device on an escalator, even with an attendant.

### L. MAINTENANCE

Proper maintenance of your mobility device will ensure a long life for the product. Inspect and maintain this mobility device per the Maintenance details listed in the back of this booklet. If you detect a problem, make sure to service or repair the product before use.

## VI. WARNINGS FOR COMPONENTS & OPTIONS

Below are warnings for various standard and optional components for your Mighty Lite. (Options may vary based on your model.) If you fail to heed these warnings, you may cause damage to your chair, a fall, tip-over or a loss of control that may cause severe injury to the child, caregiver or others.

### A. TRANSIT OPTION

1. Use only Wheelchair Tiedown and Occupant Restraint Systems (WTORS) which meet the requirements of SAE J2249 Recommended Practice - Wheelchair Tiedown and Occupant Restraint Systems for Use in Motor Vehicles. Do not use WTORS designed to rely on the transport chair structure to transfer occupant restraint loads to the vehicle.
2. The Kid Kart Mighty Lite has been dynamically tested with the occupant facing forward mode for a 30 mph (48-km/h) frontal impact test.
3. To reduce the potential of injury to vehicle occupants, mobility device mounted accessories, such as trays and respiratory equipment, should be removed and secured separately.
4. Postural supports and positioning devices should not be relied on for occupant restraint.
5. Do not alter or substitute mobility device frame parts, components or seating.
6. Sudden stops or impacts may structurally damage your transport chair. Mobility devices involved in such incidents should be replaced.

### B. TRAY SUPPORTS

1. Do not lift this product by its tray supports.
2. Do not rest drinks on tray supports.

### C. CUSHIONS AND SEATING ACCESSORIES

This mobility device's seating was designed for comfort and postural support. If seating component modifications are necessary, consult your therapist or clinician.

### D. FASTENERS

Many of the screws, screws and nuts on this product are special high-strength fasteners. ONLY use fasteners provided by an authorized supplier (or ones of the same type and strength, as indicated by the markings on the heads), do not over- or under-tightened fasteners, and If screws or screws become loose, tighten them as soon as you can.



**E. FOOTPLATES**

1. At the lowest point, footplates should be at least 2" off the ground. If set too low, footrest may interfere with obstacles you may encounter during normal use.
2. Adjustment of the footplate may cause interference with the casters in some positions. This may affect your ability to steer the Mighty Lite chair.
3. Avoid putting weight on the footrest. The mobility device may tip forward (or backward if shell has been reversed).
4. Never lift this mobility device by the footrest.

**F. POSITIONING BELTS**

Use positioning belts ONLY to help support the child's posture.

1. Make sure the rider does not slide down in the mobility device seat. The belts must be snug, but must not be so tight that they interfere with breathing. You should be able to slide your open hand, flat, between the belt and the rider.
2. Use positioning belts with a cooperative rider only. Make sure that you can remove the belts in an emergency.
3. NEVER Use Positioning Belts:
  - As a restraint.
  - On a child who is comatose, agitated or is prone to seizures.
  - As a motor vehicle restraint.

**G. POWER DRIVE**

Do not install a power drive on this product.

**H. WHEEL LOCKS**

Never engage wheel locks to slow or stop this product when it is moving. To keep the rear wheels from rolling, always engage both rear wheel locks when you transfer your child to or from this mobility device. Make sure lock arms embed in tires at least 1/8" when locked.

**I. MODIFIED SEATING SYSTEMS**

Do not change the seating system of your chair UNLESS you consult your health care professional.

**J. UPHOLSTERY FABRIC**

Replace worn or torn seating cover fabrics as soon as you can, and be aware that laundering or excess moisture will reduce flame retardation of the fabric.

**VII. OPERATING INSTRUCTIONS****A. WHEEL LOCKS (FIG. 1)**

1. To engage, pull both wheel lock levers back until the locking bar pushes into the wheel and the lever snaps into the locked position.
2. To disengage, lift both wheel lock levers until the locking bar comes free of the tire and the lever travels to its end position.

**B. UNFOLDING**

1. Unhook closure strap.
2. Stand chair on the rear wheels, hold one handle (Fig. 2A) and press firmly on the seat rail on the opposite side (Fig. 2B)
3. Press down the seat rail until the chair is completely open.
4. With your foot, press down the locking brace in its full extended position (Fig. 3A).

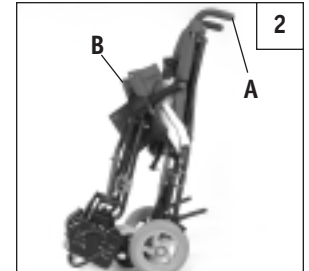
**⚠ WARNING**

**Before seating a child always check that the mobility base is properly locked in its upright position and that the wheel locks are engaged.**

**C. FOLDING**

The transport chair is designed to fold compactly for ease of portability.

1. Engage wheel locks. Remove the child from the product.
2. Remove headrest extension (Fig. 4A) and swing footrests to the side (Fig. 4B).
3. With your foot, lift the locking brace (Fig. 3A) from the center.
4. Hold one push handle (Fig. 2A) as you pull the opposite seat rail towards you (Fig 2B).
5. Lean chair on its back and press the foot plates down to a complete fold.
6. Use the closure strap to maintain the chair in a compact package (Fig. 4C).

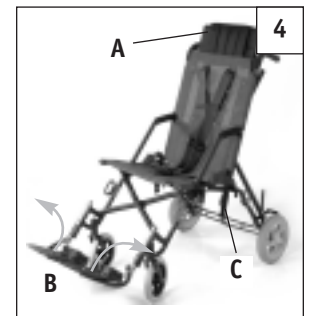
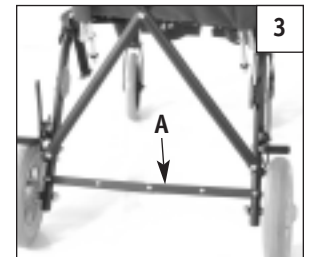

**D. TRANSIT USE**

1. If possible and feasible, the rider should transfer to the vehicle seat and use the vehicle restraints.
2. If the mobility base is used for transport, it must be used with occupant facing forward in the vehicle.
3. The occupant must not weigh more than 150 pounds.
4. The location of the securement points is shown. (See Figs. 5, 6)
5. Use only with WTORS that have been installed in accordance with the manufacturer's instructions and SAE J2249.
6. Attach WTORS to the securement points in accordance with the manufacture's instructions and SAE J2249.
7. Attach occupant restraints in accordance with the manufacturer's instructions and SAE J2249.

**E. TRANSIT OPTION INSTALLATION****Tools Required:**

1. 10mm socket & ratchet
2. 4mm Allen wrench
3. Torque wrench

**To Install the Front Transit Bracket (Figure 7)**

1. Install (2) 10 mm x 38.5 mm flat head cap screws through the transit bracket and plastic saddles continuing screws through holes in frame on the right side of transport chair. Ensure the curved portion of the saddles contact the round tubing. Front transit brackets are mounted on the outside of the frame with both front transit brackets facing forward.
2. Install flat washers and nylock nuts to secure screws. Hand tighten.
3. Repeat procedure for the left side of frame.
4. Ensure both front brackets are mounted to the outside of the frame and facing forward.

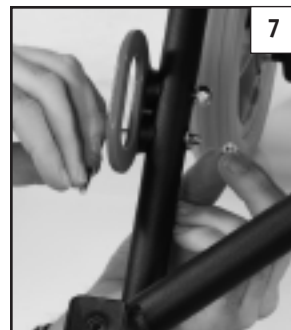

5. Torque all four front nylock nuts to 8 N/M (71 in/lbs).
6. Continue on to rear transit bracket installation.

**To Install the Rear Transit Bracket (Figure 8)**

1. Install (2) 10mm x 38.5 mm flat head cap screws through the transit bracket and plastic saddles continuing screws through holes in frame on the right side of transport chair. Ensure the curved portion of the saddles contact the round tubing. Rear transit brackets are mounted on the inside of the frame with both rear transit brackets facing towards the rear.
2. Install saddles and nylock nuts to secure screws. Hand tighten.
3. Repeat procedure for left side of frame.
4. Ensure both rear brackets are mounted to the inside side of frame and facing towards the rear.
5. Torque all four rear nylock nuts to 8 N/M (71 in/lbs.).

**F. POSITIONING AND GROWTH ADJUSTMENTS GUIDE****⚠ WARNING**

If necessary, a healthcare professional should make any changes to the positioning and growth adjustments. These adjustments are very important to the orthopedic and neurological needs of the child. Care should be taken to make sure they are appropriate.

Use the provided tools to perform the adjustment of your Mighty Lite.

In general, positioning and growth adjustments should be done in the following order:

1. Adjust seat
2. Adjust back
3. Adjust pelvic positioning belt
4. Adjust footrest
5. Adjust head support
6. Make other standard and optional adjustments needed
7. Check to be sure that all adjustment screws are tight

## G. SEAT DEPTH ADJUSTMENT

1. Determine the proper seat depth.
2. Refer to Seat Depth Matrix to determine chair configuration.
3. Your Mighty Lite comes with two sets of seat extension tubes, one pair long (L) and one pair short (S). The short seat extension tubes (S) come pre-assembled with the chair. The long seat extension tubes (L) are located along with the User's Manual. (Fig. X)
4. To change the seat depth using the short seat extension tube (S), undo the Velcro that attaches the back panel to the seat panel of the sling. (Fig. 9)
5. Relieve fabric tension by partially folding the chair.
6. Depress spring button on the side of the seat rail (Fig. 10-A) and move seat tube to the desired depth until the spring button relocates.
7. Repeat operation on the other side of seat.
8. Reattach the seat panel to the back panel of the sling (Fig. 9) for proper adjustment.
9. To change the seat depth using the long seat extension tube (L), undo the Velcro that attaches the back panel to the seat panel of the sling. (Fig. 9)
10. Remove seat extension tube screw (Fig. Y).
11. Relieve fabric tension by partially folding the chair.
12. Remove short seat extension tubes by depressing the spring button on the side of the seat rail (Fig. 10-A) and pulling the tube away from the chair.
13. Install the long seat extension tube (L) by depressing the spring button on the side of the extension tube (Fig. 10-A). Insert tube into chair to the desired depth until the spring button relocates.
14. Replace seat extension tube screw (Fig. Y).
15. Repeat operation on the other side of seat.
16. Reattach the seat panel to the back panel of the sling (Fig. 9) for proper adjustment.

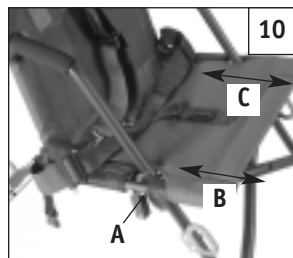

## H. SEAT AND BACK ANGLE ADJUSTMENT

### To adjust the seat angle:

1. Locate the seat angle adjustment bolt along the seat rail (Fig. 11A).
2. Loosen and remove fasteners from both sides of the seat and relocate as required in the top or bottom hole (Fig. 12). See Set-up matrix for proper location.
3. Secure the nuts tightly.

**CAUTION**– The modification of the seat angle will affect the back angle. Consult matrix to validate the adjustment of the back in conformity of the seat-to-back angle. Refer to the “Back Angle Adjustment” section if necessary.

### To adjust the back angle:

1. To adjust the back angle relative to the seat, consult the Set-up Matrix (Page 24).
2. To relocate the back post along the seat rail, loosen and remove fasteners from both sides of the seat (Fig. 12) and align the back posts along the seat rail in the required location.
3. Put fasteners back in place and secure the nuts tightly.
4. When the adjustment of the top of the back post is necessary according to the Set-up Matrix, remove fasteners from both sides of the frame (Fig. 13). Align the cross-brace along the back post in the required location. Insert fasteners on both sides. Secure the nuts tightly.

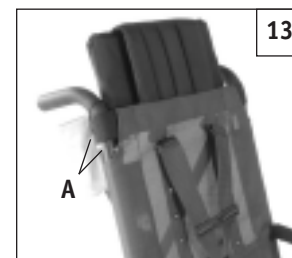
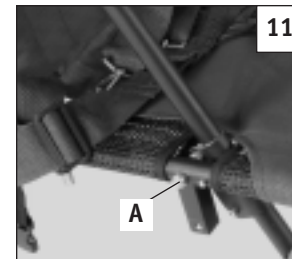

## I. FOOTREST ADJUSTMENTS

### To adjust or remove footrest

1. Pull out the locking pin (Fig. 14A).
2. Move the footplate extension tube up or down to the desired position.
3. Align the holes of the footrest with the holes of the housing bracket.
4. Put the locking pin back in place.

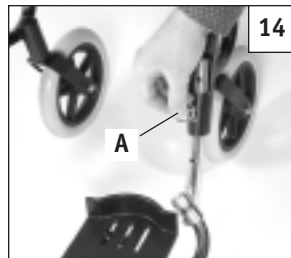

### Range adjustment

To modify the range of adjustment of the footrest by inverting the housing bracket:

1. Remove footrest.
2. Using a Philips screw driver, remove both screws from the housing bracket (Fig. 15A).
3. Relocate the housing facing up or down as desired (Fig. 15).
4. Put both screws back in place.

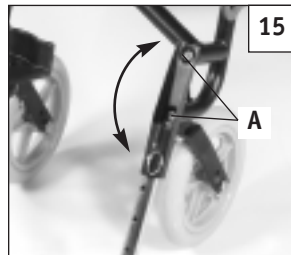

### To modify the range of adjustment by inverting the footrest extension tube

1. Remove the footrest.
2. Remove the cap head screw (Fig. 16A) from the footplate support using a hex wrench and pull the footplate assembly off the extension tube.
3. Reverse the footrest extension tube orientation.
4. Insert the footplate assembly back in place, and tighten the cap head screw.

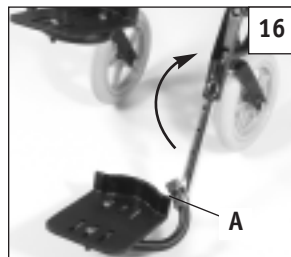

### Depth Adjustment

1. Loosen both fasteners on the footplate (Fig. 17A).
2. Slide the footplate to the desired position.
3. Tighten both fasteners.

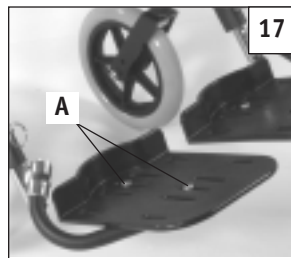

## J. PELVIC POSITIONING BELT LENGTH ADJUSTMENT

1. Remove any belt twists and place the belts outside of the seating area.
2. Engage wheel locks, seat the child, and snap the pelvic positioning belt ends together.
3. Adjust belt length to provide a snug fit. The adjusters (Fig. 18A) on both sides must be adjusted symmetrically.

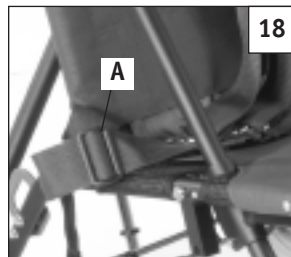

## K. CRUTCH STRAP DEPTH ADJUSTMENT

1. Determine the appropriate depth for the user.
2. Undo the adjuster (Fig. 19A).
3. Relocate the strap in the appropriate slot (Fig. 19B).
4. Thread the strap back in the adjuster.

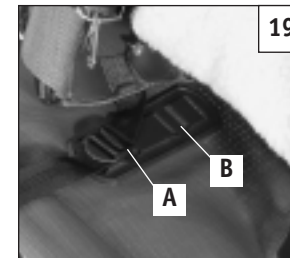

## L. "H" HARNESS

### "H" Harness Adjustment

1. Place child in the chair and fasten the pelvic positioning belt.
2. Position the child's hips and buckle the pelvic positioning belt to the proper position.
3. Connect both straps of the "H" harness to the pelvic positioning belt.
4. Adjust both shoulder straps using the adjusters to get a snug fit (Fig. 20A).

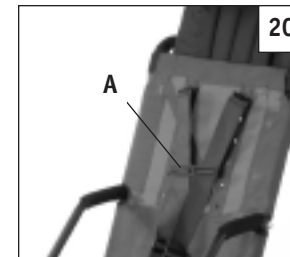

If required, the height of the attachment point of the shoulder straps can be adjusted. To do so, undo the knob (Fig. 21), and take the insert out of the grommet on the upholstery. Relocate the insert in the suitable position and tighten in place with the knob.



## M. HEADREST EXTENSIONS

### Height Adjustment (All head supports)

Adjust the rubber stop up or down along the stem (Fig. 22A) on both sides of the headrest extension.

### Width Adjustment

1. Remove the headrest cover from the structure (Fig. 22B).
2. Extend or reduce to the desired width by adjusting the independent flaps one on the other (Fig. 22C).
3. Put the cover back in place.

### Taking the headrest extension on and off the chair

1. To remove headrest extension, fold the chair slightly and pull the stems out the sleeves.
2. To put the headrest extension back in place, fold the chair slightly and slide the stems into the sockets until the down to the rubber stops.

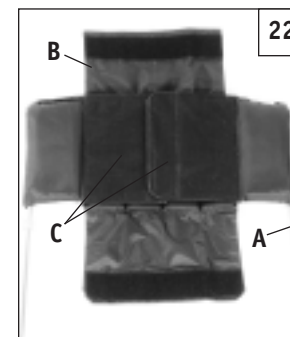

VIII. SET-UP MATRICES

FRAME ADJUSTMENTS

SEAT DEPTH MATRIX

|                | Back Angle  | 12" width  |      |      |      |      | 14" width  |      |      |      |      |
|----------------|-------------|------------|------|------|------|------|------------|------|------|------|------|
|                |             | Seat Depth |      |      |      |      | Seat Depth |      |      |      |      |
|                |             | Hole: 8    | 9    | 10/8 | 9    | 10   | Hole: 8    | 9    | 10/8 | 9    | 10   |
| Seat Angle 15° | 85°         | 13.5       | 14.5 | 15.5 | 16.5 | 17.5 | 15.0       | 16.0 | 17.0 | 18.0 | 19.0 |
|                | 90°         | 12.5       | 13.5 | 14.5 | 15.5 | 16.5 | 14.0       | 15.0 | 16.0 | 17.0 | 18.0 |
|                | 95°         | 11.5       | 12.5 | 13.5 | 14.5 | 15.5 | 13.0       | 14.0 | 15.0 | 16.0 | 17.0 |
| Seat Angle 22° | 85°         | 11.5       | 12.5 | 13.5 | 14.5 | 15.5 | 13.0       | 14.0 | 15.0 | 16.0 | 17.0 |
|                | 90°         | 10.5       | 11.5 | 12.5 | 13.5 | 14.5 | 12.0       | 13.0 | 14.0 | 15.0 | 16.0 |
|                | 95°         | 9.5        | 10.5 | 11.5 | 12.5 | 13.5 | 11.0       | 12.0 | 13.0 | 14.0 | 15.0 |
|                | Chair Width | 23.0       |      |      |      |      | 25.0       |      |      |      |      |
|                | Back Height | 22.2       |      |      |      |      | 21.3       |      |      |      |      |

|                | Back Angle  | 16" width  |      |      |      |      | 18" width  |      |      |      |      |
|----------------|-------------|------------|------|------|------|------|------------|------|------|------|------|
|                |             | Seat Depth |      |      |      |      | Seat Depth |      |      |      |      |
|                |             | Hole: 8    | 9    | 10/8 | 9    | 10   | Hole: 8    | 9    | 10/8 | 9    | 10   |
| Seat Angle 15° | 85°         | 15.5       | 16.5 | 17.5 | 18.5 | 19.5 | 16.5       | 17.5 | 18.5 | 19.5 | 20.5 |
|                | 90°         | 14.5       | 15.5 | 16.5 | 17.5 | 18.5 | 15.5       | 16.5 | 17.5 | 18.5 | 19.5 |
|                | 95°         | 13.5       | 14.5 | 15.5 | 16.5 | 17.5 | 14.5       | 15.5 | 16.5 | 17.5 | 18.5 |
| Seat Angle 22° | 85°         | 13.5       | 14.5 | 15.5 | 16.5 | 17.5 | 14.5       | 15.5 | 16.5 | 17.5 | 18.5 |
|                | 90°         | 12.5       | 13.5 | 14.5 | 15.5 | 16.5 | 13.5       | 14.5 | 15.5 | 16.5 | 17.5 |
|                | 95°         | 11.5       | 12.5 | 13.5 | 14.5 | 15.5 | 12.5       | 13.5 | 14.5 | 15.5 | 16.5 |
|                | Chair Width | 27.0       |      |      |      |      | 29.0       |      |      |      |      |
|                | Back Height | 23.6       |      |      |      |      | 23.4       |      |      |      |      |

- Indicates Short Seat Tube.
- Indicates Short Seat Tube in hole 10, OR Long Seat Tube in hole 8.
- Indicates Long Seat Tube.

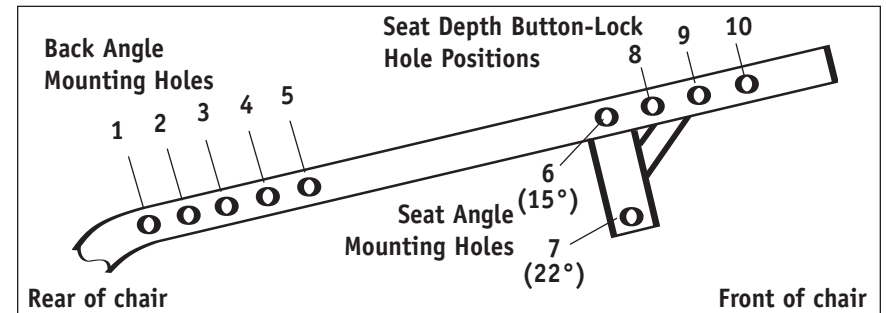

SEAT & BACK ANGLE MATRIX

|                |                                  | Mounting Hole Pattern  |                        |                        |
|----------------|----------------------------------|------------------------|------------------------|------------------------|
|                |                                  | Seat-to-Back Angle 85° | Seat-to-Back Angle 90° | Seat-to-Back Angle 95° |
| Seat Angle 15° | Seat-to-Back Angle Mounting Hole | 1                      | 2                      | 3                      |
|                | Seat Angle Mounting Hole         | 6                      | 6                      | 6                      |
| Seat Angle 22° | Seat-to-Back Angle Mounting Hole | 3                      | 4                      | 5                      |
|                | Seat Angle Mounting Hole         | 7                      | 7                      | 7                      |



**FOOTREST HEIGHT MATRIX**

| 15 Degree Seat Angle   |       |       |       |       |       |       |       |       |
|--|-------|-------|-------|-------|-------|-------|-------|-------|
| <b>Configuration 1<br/>Standard Receiver,<br/>Standard Footplate</b> | 22.25 | 21.50 | 20.75 | 20.00 | 19.25 | 18.50 | 17.75 | 17.00 |
| Footrest Tube Hole   | 1     | 1     | 2     | 2     | 3     | 3     | 4     | 4     |
| Receiver Hole  | 2     | 1     | 2     | 1     | 2     | 1     | 2     | 1     |
| <b>Configuration 2<br/>Reversed Receiver,<br/>Standard Footplate</b> | 16.00 | 15.25 | 14.50 | 13.75 | 13.00 | 12.25 | 11.50 | 10.75 |
| Footrest Tube Hole   | 1     | 1     | 2     | 2     | 3     | 3     | 4     | 4     |
| Receiver Hole  | 1     | 2     | 1     | 2     | 1     | 2     | 1     | 2     |
| <b>Configuration 3<br/>Standard Receiver,<br/>Inverted Footplate</b> | 12.75 | 12.00 | 11.25 | 10.50 | 9.75  | 9.00  | 8.25  | 7.50  |
| Footrest Tube Hole   | 4     | 4     | 3     | 3     | 2     | 2     | 1     | 1     |
| Receiver Hole  | 2     | 1     | 2     | 1     | 2     | 1     | 2     | 1     |
| <b>Configuration 4<br/>Reversed Receiver,<br/>Inverted Footplate</b> | 6.50  | 5.75  | 5.00  | 4.25  | 3.50  | 2.75  | 2.00  | 1.25  |
| Footrest Tube Hole   | 4     | 4     | 3     | 3     | 2     | 2     | 1     | 1     |
| Receiver Hole  | 1     | 2     | 1     | 2     | 1     | 2     | 1     | 2     |

| 22 Degree Seat Angle   |       |       |       |       |       |       |       |       |
|--|-------|-------|-------|-------|-------|-------|-------|-------|
| <b>Configuration 1<br/>Standard Receiver,<br/>Standard Footplate</b> | 26.00 | 25.25 | 24.50 | 23.75 | 23.00 | 22.25 | 21.50 | 20.75 |
| Footrest Tube Hole   | 1     | 1     | 2     | 2     | 3     | 3     | 4     | 4     |
| Receiver Hole  | 2     | 1     | 2     | 1     | 2     | 1     | 2     | 1     |
| <b>Configuration 2<br/>Reversed Receiver,<br/>Standard Footplate</b> | 19.75 | 19.00 | 18.25 | 17.50 | 16.75 | 16.00 | 15.25 | 14.50 |
| Footrest Tube Hole   | 1     | 1     | 2     | 2     | 3     | 3     | 4     | 4     |
| Receiver Hole  | 1     | 2     | 1     | 2     | 1     | 2     | 1     | 2     |
| <b>Configuration 3<br/>Standard Receiver,<br/>Inverted Footplate</b> | 16.50 | 15.75 | 15.00 | 14.25 | 13.50 | 12.75 | 12.00 | 11.25 |
| Footrest Tube Hole   | 4     | 4     | 3     | 3     | 2     | 2     | 1     | 1     |
| Receiver Hole  | 2     | 1     | 2     | 1     | 2     | 1     | 2     | 1     |
| <b>Configuration 4<br/>Reversed Receiver,<br/>Inverted Footplate</b> | 10.25 | 9.50  | 8.75  | 8.00  | 7.25  | 6.50  | 5.75  | 5.00  |
| Footrest Tube Hole   | 4     | 4     | 3     | 3     | 2     | 2     | 1     | 1     |
| Receiver Hole  | 1     | 2     | 1     | 2     | 1     | 2     | 1     | 2     |



Footrest Tube Holes

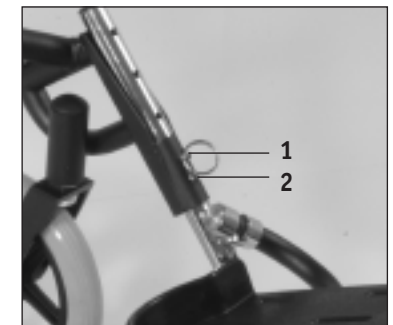

Receiver Holes



Standard Footplate



Inverted Footplate



Standard Receiver



Reversed Receiver

**IX. MAINTENANCE**

1. Lubricate moving parts periodically to keep the chair easy to fold.
2. At least every four months, check all screws and knobs for tightness. If parts are missing, broken, damaged or worn, then stop use of the product until repairs are made, using factory-authorized parts.
3. Wipe down all frame components periodically to maintain cleanliness.
4. Hand wash and air-dry the fabric components as needed.
5. Keep wheel lock and wheel free of mud, dirt or snow.
6. Lubricate all moving components with Teflon lubricant only.

**CAUTION**– Use of any other types of lubricant tend to foul moving components and may void warranty.

7. Check the wheel locks for proper operation. Rear wheels should skid rather than roll when pushed with a child in the product.

**X. LIMITED WARRANTY****A. FOR LIFETIME**

Sunrise warrants the frame and cross brace if applicable of this wheelchair against defects in materials and workmanship for the life of the original purchaser.

The expected life of this frame is five years.

**B. FOR ONE (1) YEAR**

We warrant all Sunrise-made parts and components of this wheelchair against defects in materials and workmanship for one year from the date of first consumer purchase.

**C. LIMITATIONS**

1. We do not warrant:
  - a. Tires and tubes, upholstery, pads and push-handle grips.
  - b. Damage from neglect, accident, misuse, or from improper installation or repair.
  - c. Products modified without Sunrise Medicals express written consent.
  - d. Damage from exceeding the weight limit.
2. This warranty is VOID if the original chair serial number tag is removed or altered.
3. This warranty applies in the USA only. Check with your supplier to find out if international warranties apply.
4. This warranty is not transferable and only applies to the first consumer purchase of this wheelchair through an authorized Sunrise Medical dealer.

**D. WHAT WE WILL DO**

Our sole liability is to repair or replace covered parts. This is the exclusive remedy for consequential damages.

**E. WHAT YOU MUST DO**

1. Obtain from us, while this warranty is in effect, prior approval for return or repair of covered parts.
2. Return the wheelchair or part(s), freight pre-paid, to Sunrise Mobility Products Division
3. Pay the cost of labor to repair, remove or install parts.

**F. NOTICE TO CONSUMER**

1. If allowed by law, this warranty is in place of any other warranty (written or oral, express or implied, including a warranty of merchantability, or fitness for a particular purpose).
2. This warranty gives you certain legal rights. You may also have other rights that vary from state to state.

Record your serial number here for future reference:

---



The Kid Kart Mighty Lite offers a full range of accessories and positioning options to allow a customized fit just for you.



**Three Points Positioning Belt**  
helps increase pelvic stabilization and positioning.



**Foam Wedge**  
used to increase stabilization and modify positioning.

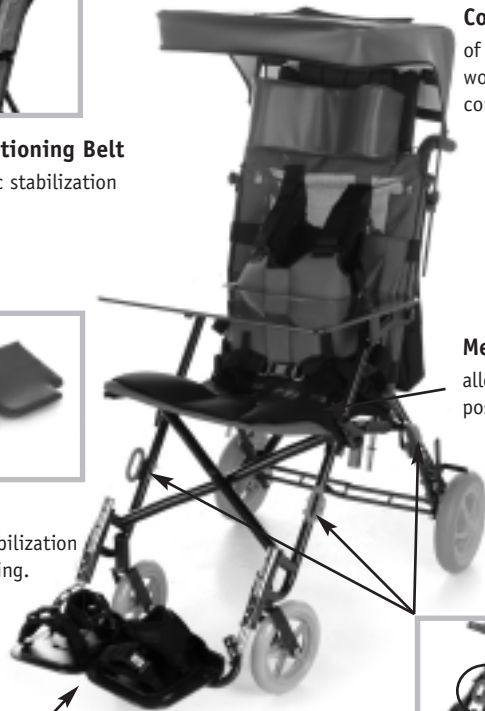

**H-Harness & Padded Covers**  
of imitation lamb's wool provide increased comfort and support.

**Medial Thigh Support**  
allows for better positioning of thighs.



**Transit Option**  
provides crash-tested assurance for tying down the chair during transportation.

**Foot & Ankle Positioners**  
provide custom adjustments for feet and ankles and come in 4 sizes.

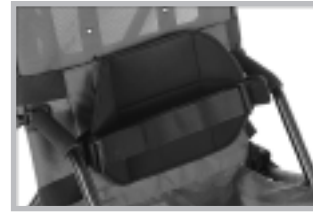

**Adjustable Lateral Support & Scolli Strap**  
is fully adjustable and provides increased trunk support and can be used to accommodate scoliosis.



**Headrest Cover Canopy**  
Keep cool and dry with the removable and height adjustable Headrest Cover Canopy. Includes flap-covered observation window.

**Full Torso Support Vest**  
is a fully adjustable support vest that comfortably provides the most trunk support. Helps prevent forward slumping and maintains midline seated position.

**Padded Headwings**  
provide additional lateral support for your head

**Upper Extremity Support Tray**  
provides trunk stability and the perfect place to have a meal.



**Removable Utility Bag**  
provides an ideal place to keep essential items close at hand.



**Angle Adjustable Footplates**  
provide near-infinite range of angles to support foot positions.



**Headrest Extension**  
is fully adjustable in both width and height.



---

**Sunrise Medical, Inc.**

© 2005, Sunrise Medical 11.05

100336 Rev E